

ORGANIZE SPACE

LET'S REORG



■ **WORKSTATIONS SERIES WORK**

SEVERAL WORKTOPS TYPES AVAILABLE

STANDARDISED ELECTRIC AND PNEUMATIC SYSTEM

VERSATILE

SEVERAL ACCESSORIES SERIES



GANZE SPACE LET'S REOR

SERIES WORK

## WOODEN WORKTOPS

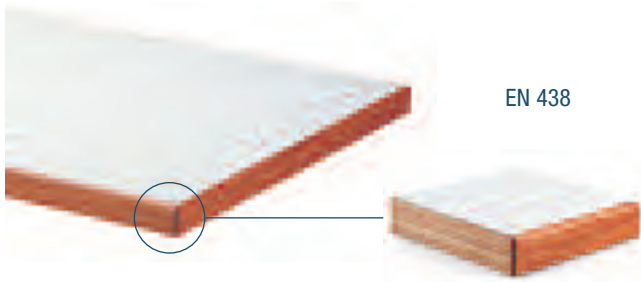

EN 438

**MULTIPLEX WORKTOP COVERED WITH GREY LAMINATE WITH SOLID WOOD EDGING**  
 This is a multiplex worktop to which a sheet of light grey matt laminate has been glued. The edges are finished in a solid beech wood.

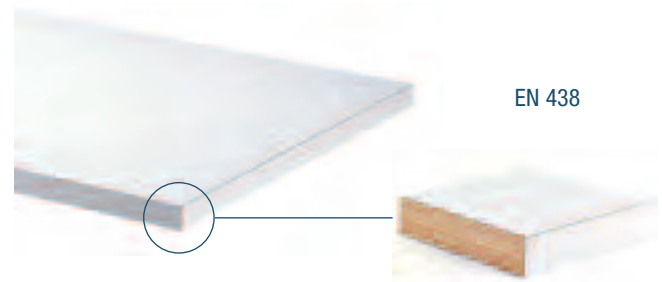

EN 438

**MULTIPLEX WORKTOP COVERED WITH GREY LAMINATE WITH LAMINATE EDGING**  
 This is a multiplex worktop to which a sheet of light grey matt laminate has been glued. The edges are also finished with the same laminate.

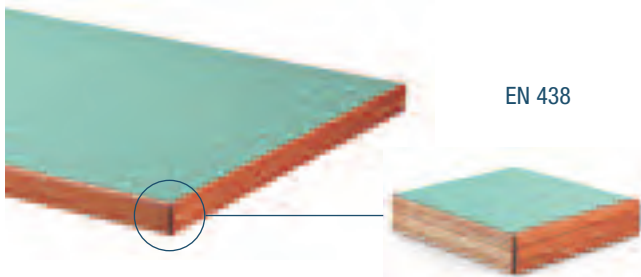

EN 438

**MULTIPLEX WORKTOP COVERED WITH GREEN LAMINATE WITH SOLID WOOD EDGING**  
 This is a multiplex worktop to which a sheet of light green matt laminate has been glued. The edges are finished in a solid beech wood.

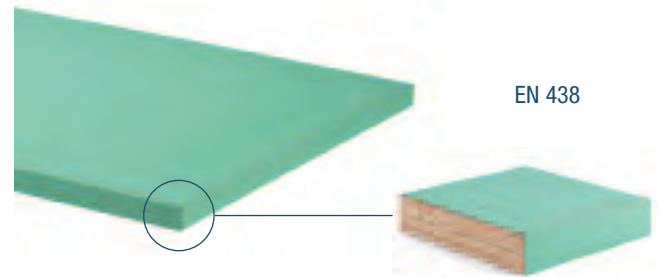

EN 438

**MULTIPLEX WORKTOP COVERED WITH GREEN LAMINATE WITH LAMINATE EDGING**  
 This is a multiplex worktop to which a sheet of light green matt laminate has been glued. The edges are also finished with the same laminate.

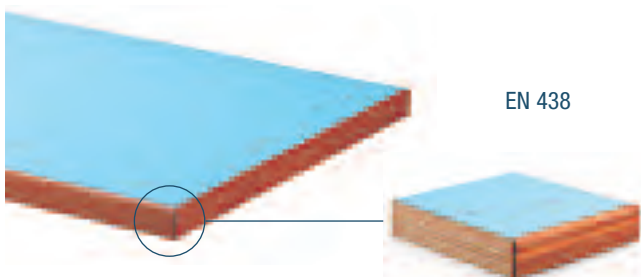

EN 438

**MULTIPLEX WORKTOP COVERED WITH BLUE LAMINATE WITH SOLID WOOD EDGING**  
 This is a multiplex worktop to which a sheet of light blue matt laminate has been glued. The edges are finished in a solid beech wood.

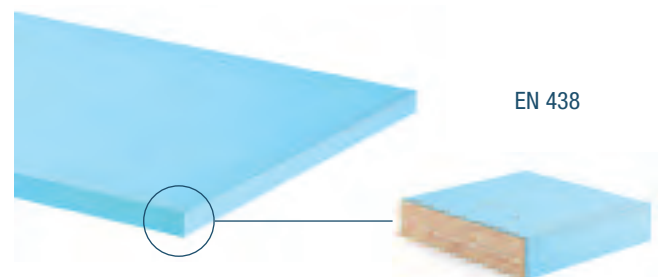

EN 438

**MULTIPLEX WORKTOP COVERED WITH BLUE LAMINATE WITH LAMINATE EDGING**  
 This is a multiplex worktop to which a sheet of light blue matt laminate has been glued. The edges are also finished with the same laminate.

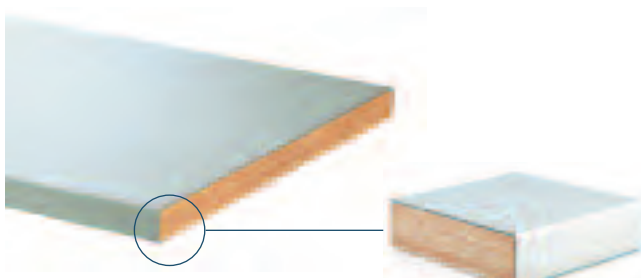

**MULTIPLEX WORKTOP WITH GALVANISED STEEL COVER**

This includes a multiplex worktop covered with a 2 mm thickness galvanised layer of sheet steel. This type of covering makes the worktop abrasion, oil and grease resistant.

For other types of worktops see catalogue **no. 300 Workstations**

## MULTIPLEX WORKTOP

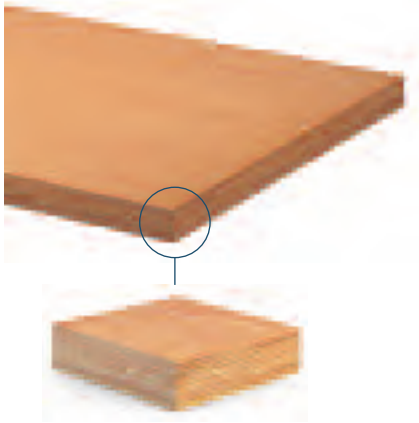

The multiplex worktop includes various layers of beech wood which are planed, glued and pressed together. This makes the worktop non-deformable and load and wear resistant.

| WORKTOP DIMENSION mm | ORD. NO. 30 mm THICKNESS | ORD. NO. 40 mm THICKNESS | ORD. NO. 50 mm THICKNESS |
|----------------------|--------------------------|--------------------------|--------------------------|
| 1024x750             | -                        | F BI A214 00 00          | -                        |
| 1024x800             | -                        | -                        | F BI A514 00 00          |
| 1300x750             | -                        | F BI A228 00 00          | F BI A428 00 00          |
| 1300x800             | -                        | F BI A328 00 00          | F BI A528 00 00          |
| 1500x750             | -                        | F BI A242 00 00          | F BI A442 00 00          |
| 1500x800             | *F BI A142 00 00         | F BI A342 00 00          | F BI A542 00 00          |
| 2000x750             | -                        | F BI A270 00 00          | F BI A470 00 00          |
| 2000x800             | *F BI A170 00 00         | F BI A370 00 00          | F BI A570 00 00          |
| 2500x750             | -                        | F BI A284 00 00          | F BI A484 00 00          |
| 2500x800             | -                        | F BI A384 00 00          | F BI A584 00 00          |
| 3000x750             | -                        | **F BI A298 00 00        | *F BI A498 00 00         |
| 3000x800             | -                        | **F BI A398 00 00        | *F BI A598 00 00         |

\*\*For modular workbenches only

\*For mobile workbenches series F CA - F CC

## WORKTOP WITH 3 CROSS-GLUED LAYERS

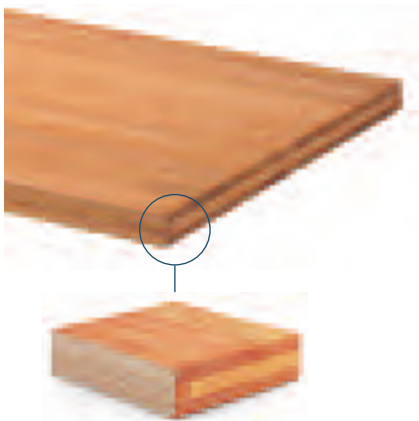

This is made from three cross-glued layers of beech wood in order to form a smooth surface which is then treated with an antiseptic material. The three layers are joined together by a toothed milling process which offers a larger connection surface.

| WORKTOP DIMENSION mm | ORD. NO. 30 mm THICKNESS | ORD. NO. 40 mm THICKNESS | ORD. NO. 50 mm THICKNESS |
|----------------------|--------------------------|--------------------------|--------------------------|
| 1024x750             | -                        | -                        | -                        |
| 1024x800             | -                        | -                        | -                        |
| 1300x750             | -                        | -                        | F BK A428 00 00          |
| 1300x800             | -                        | -                        | F BK A528 00 00          |
| 1500x750             | -                        | -                        | F BK A442 00 00          |
| 1500x800             | -                        | -                        | F BK A542 00 00          |
| 2000x750             | -                        | -                        | F BK A470 00 00          |
| 2000x800             | -                        | -                        | F BK A570 00 00          |
| 2500x750             | -                        | -                        | F BK A484 00 00          |
| 2500x800             | -                        | -                        | F BK A584 00 00          |
| 3000x750             | -                        | -                        | F BK A498 00 00          |
| 3000x800             | -                        | -                        | F BK A598 00 00          |

## STEEL COVER WITH OIL PROOF RUBBER COATING

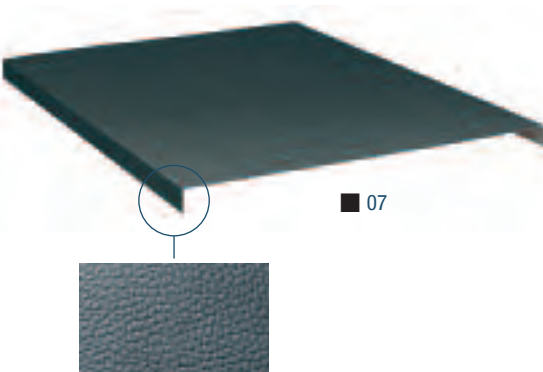

This rubber is between 1.2 and 1.5 mm thickness. The rubber-coated electrogalvanised steel sheet featuring a L-shaped profile at the two long sides, can also be supplied separately. It is easy to be fitted as no screws are required.

| WORKTOP DIMENSION mm | ORD. NO. 33 mm THICKNESS | ORD. NO. 43 mm THICKNESS | ORD. NO. 53 mm THICKNESS |
|----------------------|--------------------------|--------------------------|--------------------------|
| 1024x750             | -                        | F BL 2630 00 07          | -                        |
| 1024x800             | -                        | -                        | F BL 2835 00 07          |
| 1300x750             | -                        | F BL 2645 00 07          | F BL 2845 00 07          |
| 1300x800             | -                        | F BL 2650 00 07          | F BL 2850 00 07          |
| 1500x750             | -                        | F BL 2660 00 07          | F BL 2860 00 07          |
| 1500x800             | F BL 2465 00 07          | F BL 2665 00 07          | F BL 2865 00 07          |
| 2000x750             | -                        | F BL 2690 00 07          | F BL 2890 00 07          |
| 2000x800             | F BL 2495 00 07          | F BL 2695 00 07          | F BL 2895 00 07          |
| 2500x750             | -                        | F BL 2705 00 07          | F BL 2905 00 07          |
| 2500x800             | -                        | F BL 2710 00 07          | F BL 2910 00 07          |
| 3000x750             | -                        | F BL 2720 00 07          | F BL 2920 00 07          |
| 3000x800             | -                        | F BL 2725 00 07          | F BL 2925 00 07          |



## SERIES WORK 13

LENGTH = 1300 mm DEPTH = 800 mm (27x36 Eh)



**ORD. NO. F BH A328 S1 04**  
RAL 5012

**WORKSTATION****ORD. NO.****F BH A328 S1 04**

Dimensions mm 1300x800x840/1472 h

Tools and drawer partitioning sets excluded

All the workbenches series WORK components are supplied without pre-drilling and bolts. To fix the components to the workbenches series WORK it is necessary to order the following **FIXING MATERIAL**:

**ORD. NO. F BL 9021 00 00**

For bench leg, adjustable bench leg, bench leg with wheels, cabinet with steel vice, bench leg for power fittings

**ORD. NO. F BL 9011 00 00**

Cabinets with shelves or doors

RAL 7000 F. ....01

RAL 6011 F. ....02

RAL 5012 F. ....04

RAL 7035 F. ....08

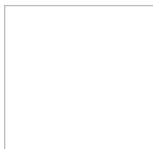
**SUPPLEMENTARY PARTS ■**

■ **Spare key.** Always indicate the number on the cylinder lock of the key to be replaced.

ORD. NO. R CSC 0002 00

■ **Master key.** This type of key opens all the 45 and 46 series locks.

ORD. NO. R CSC 0001 00



LENGTH = 1300 mm DEPTH = 800 mm (27x36 Eh)

SERIES WORK 13-80

SHELVES 800 mm DEEP

| ORD. NO.               | TYPE OF WORKTOP               | THICKNESS mm | LOAD CAP. kg |
|------------------------|-------------------------------|--------------|--------------|
| <b>F BI A528 01 04</b> | Multiplex                     | 50           | 1500         |
| <b>F BI A328 01 04</b> | Multiplex                     | 40           | 1200         |
| <b>F BK A528 01 04</b> | 3 cross-glued layers          | 50           | 1500         |
| <b>F BH A328 01 04</b> | Grey laminate with solid wood | 40           | 1200         |
| <b>F BH B328 01 04</b> | Grey laminate                 | 40           | 1200         |

Bottom shelf, ord. no. F BI 1135 00 00, load capacity: 130 kg



| ORD. NO.               | TYPE OF WORKTOP               | THICKNESS mm | LOAD CAP. kg |
|------------------------|-------------------------------|--------------|--------------|
| <b>F BI A528 04 04</b> | Multiplex                     | 50           | 1500         |
| <b>F BI A328 04 04</b> | Multiplex                     | 40           | 1200         |
| <b>F BK A528 04 04</b> | 3 cross-glued layers          | 50           | 1500         |
| <b>F BH A328 04 04</b> | Grey laminate with solid wood | 40           | 1200         |
| <b>F BH B328 04 04</b> | Grey laminate                 | 40           | 1200         |

Bottom shelf, ord. no. F BI 1135 00 00, load capacity: 130 kg

| ORD. NO.               | TYPE OF WORKTOP               | THICKNESS mm | LOAD CAP. kg |
|------------------------|-------------------------------|--------------|--------------|
| <b>F BI A528 10 04</b> | Multiplex                     | 50           | 1500         |
| <b>F BI A328 10 04</b> | Multiplex                     | 40           | 1200         |
| <b>F BK A528 10 04</b> | 3 cross-glued layers          | 50           | 1500         |
| <b>F BH A328 10 04</b> | Grey laminate with solid wood | 40           | 1200         |
| <b>F BH B328 10 04</b> | Grey laminate                 | 40           | 1200         |

Bottom shelf, ord. no. F BI 1135 00 00, load capacity: 130 kg



| ORD. NO.               | TYPE OF WORKTOP               | THICKNESS mm | LOAD CAP. kg |
|------------------------|-------------------------------|--------------|--------------|
| <b>F BI A528 13 04</b> | Multiplex                     | 50           | 1500         |
| <b>F BI A328 13 04</b> | Multiplex                     | 40           | 1500         |
| <b>F BK A528 13 04</b> | 3 cross-glued layers          | 50           | 1500         |
| <b>F BH A328 13 04</b> | Grey laminate with solid wood | 40           | 1500         |
| <b>F BH B328 13 04</b> | Grey laminate                 | 40           | 1500         |

Bottom shelf, ord. no. F BI 0575 01 01, load capacity: 180 kg

| ORD. NO.               | TYPE OF WORKTOP               | THICKNESS mm | LOAD CAP. kg |
|------------------------|-------------------------------|--------------|--------------|
| <b>F BI A528 16 04</b> | Multiplex                     | 50           | 1500         |
| <b>F BI A328 16 04</b> | Multiplex                     | 40           | 1500         |
| <b>F BK A528 16 04</b> | 3 cross-glued layers          | 50           | 1500         |
| <b>F BH A328 16 04</b> | Grey laminate with solid wood | 40           | 1500         |
| <b>F BH B328 16 04</b> | Grey laminate                 | 40           | 1500         |

Bottom shelf, ord. no. F BI 0575 01 01, load capacity: 180 kg

KEY

RAL 7000 F. ....01 RAL 6011 F. ....02 RAL 5012 F. ....04 RAL 7035 F. ....08



- PE = Retractable shelf
- All indicated loads are net and refer to evenly distributed weights

■ Sets of partitions see page A72 - A73



## SERIES WORK 13-75

LENGTH = 1300 mm DEPTH = 750 mm (27x36 Eh)

## SHELVES 750 mm DEEP

| ORD. NO.               | TYPE OF WORKTOP               | THICKNESS mm | LOAD CAP. kg |
|------------------------|-------------------------------|--------------|--------------|
| <b>F BI A428 01 04</b> | Multiplex                     | 50           | 1500         |
| <b>F BI A228 01 04</b> | Multiplex                     | 40           | 1200         |
| <b>F BK A428 01 04</b> | 3 cross-glued layers          | 50           | 1500         |
| <b>F BH A228 01 04</b> | Grey laminate with solid wood | 40           | 1200         |
| <b>F BH B228 01 04</b> | Grey laminate                 | 40           | 1200         |

Bottom shelf, ord. no. F BI 1135 00 00, load capacity: 130 kg



| ORD. NO.               | TYPE OF WORKTOP               | THICKNESS mm | LOAD CAP. kg |
|------------------------|-------------------------------|--------------|--------------|
| <b>F BI A428 04 04</b> | Multiplex                     | 50           | 1500         |
| <b>F BI A228 04 04</b> | Multiplex                     | 40           | 1200         |
| <b>F BK A428 04 04</b> | 3 cross-glued layers          | 50           | 1500         |
| <b>F BH A228 04 04</b> | Grey laminate with solid wood | 40           | 1200         |
| <b>F BH B228 04 04</b> | Grey laminate                 | 40           | 1200         |

Bottom shelf, ord. no. F BI 1135 00 00, load capacity: 130 kg



| ORD. NO.               | TYPE OF WORKTOP               | THICKNESS mm | LOAD CAP. kg |
|------------------------|-------------------------------|--------------|--------------|
| <b>F BI A428 10 04</b> | Multiplex                     | 50           | 1500         |
| <b>F BI A228 10 04</b> | Multiplex                     | 40           | 1200         |
| <b>F BK A428 10 04</b> | 3 cross-glued layers          | 50           | 1500         |
| <b>F BH A228 10 04</b> | Grey laminate with solid wood | 40           | 1200         |
| <b>F BH B228 10 04</b> | Grey laminate                 | 40           | 1200         |

Bottom shelf, ord. no. F BI 1135 00 00, load capacity: 130 kg



| ORD. NO.               | TYPE OF WORKTOP               | THICKNESS mm | LOAD CAP. kg |
|------------------------|-------------------------------|--------------|--------------|
| <b>F BI A428 13 04</b> | Multiplex                     | 50           | 1500         |
| <b>F BI A228 13 04</b> | Multiplex                     | 40           | 1500         |
| <b>F BK A428 13 04</b> | 3 cross-glued layers          | 50           | 1500         |
| <b>F BH A228 13 04</b> | Grey laminate with solid wood | 40           | 1500         |
| <b>F BH B228 13 04</b> | Grey laminate                 | 40           | 1500         |

Bottom shelf, ord. no. F BI 0575 01 01, load capacity: 180 kg



| ORD. NO.               | TYPE OF WORKTOP               | THICKNESS mm | LOAD CAP. kg |
|------------------------|-------------------------------|--------------|--------------|
| <b>F BI A428 16 04</b> | Multiplex                     | 50           | 1500         |
| <b>F BI A228 16 04</b> | Multiplex                     | 40           | 1500         |
| <b>F BK A428 16 04</b> | 3 cross-glued layers          | 50           | 1500         |
| <b>F BH A228 16 04</b> | Grey laminate with solid wood | 40           | 1500         |
| <b>F BH B228 16 04</b> | Grey laminate                 | 40           | 1500         |

Bottom shelf, ord. no. F BI 0575 01 01, load capacity: 180 kg

RAL 7000 F. ....01

RAL 6011 F. ....02

RAL 5012 F. ....04

RAL 7035 F. ....08

## KEY ■

■ Sets of partitions see page A72 - A73

- PE = Retractable shelf
- All indicated loads are net and refer to evenly distributed weights



LENGTH = 1300 mm DEPTH = 750 mm (27x36 Eh)

SERIES WORK 13



■ RAL 5012

**WORKSTATION****ORD. NO.****F BI A528 S1 04****Dimensions mm 1300x800x850/2120 h**

Tools and chair excluded

■ **INFO**

RAL 7000 F. ....01

RAL 6011 F. ....02

RAL 5012 F. ....04

RAL 7035 F. ....08

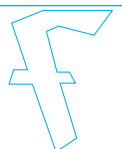
[www.famispa.com](http://www.famispa.com)



## SERIES WORK 15

LENGTH = 1500 mm DEPTH = 800 mm (27x36 Eh)



**ORD. NO. F BI A542 33 04**  
RAL 5012

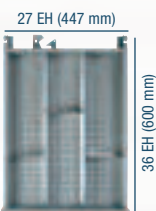

## WORKSTATION

## ORD. NO.

F BI A542 33 04

Dimensions mm 1500x800x890 h

Tools excluded

All the workbenches series WORK components are supplied without pre-drilling and bolts. To fix the components to the workbenches series WORK it is necessary to order the following **FIXING MATERIAL**:

**ORD. NO. F BL 9021 00 00**

For bench leg, adjustable bench leg, bench leg with wheels, cabinet with steel vice, bench leg for power fittings

**ORD. NO. F BL 9011 00 00**

Cabinets with shelves or doors

RAL 7000 F. ....01

RAL 6011 F. ....02

RAL 5012 F. ....04

RAL 7035 F. ....08

## SUPPLEMENTARY PARTS ■

■ **Spare key.** Always indicate the number on the cylinder lock of the key to be replaced.

ORD. NO. R CSC 0002 00

■ **Master key.** This type of key opens all the 45 and 46 series locks.

ORD. NO. R CSC 0001 00



LENGTH = 1500 mm DEPTH = 800 mm (27x36 Eh)

SERIES WORK 15-80

SHELVES 800 mm DEEP

| ORD. NO.               | TYPE OF WORKTOP               | THICKNESS mm | LOAD CAP. kg |
|------------------------|-------------------------------|--------------|--------------|
| <b>F BI A542 01 04</b> | Multiplex                     | 50           | 1000         |
| <b>F BI A342 01 04</b> | Multiplex                     | 40           | 800          |
| <b>F BK A542 01 04</b> | 3 cross-glued layers          | 50           | 1000         |
| <b>F BH A342 01 04</b> | Grey laminate with solid wood | 40           | 800          |
| <b>F BH B342 01 04</b> | Grey laminate                 | 40           | 800          |

Bottom shelf, ord. no. F BI 1340 00 00, load capacity: 130 kg



| ORD. NO.               | TYPE OF WORKTOP               | THICKNESS mm | LOAD CAP. kg |
|------------------------|-------------------------------|--------------|--------------|
| <b>F BI A542 04 04</b> | Multiplex                     | 50           | 1000         |
| <b>F BI A342 04 04</b> | Multiplex                     | 40           | 800          |
| <b>F BK A542 04 04</b> | 3 cross-glued layers          | 50           | 1000         |
| <b>F BH A342 04 04</b> | Grey laminate with solid wood | 40           | 800          |
| <b>F BH B342 04 04</b> | Grey laminate                 | 40           | 800          |

Bottom shelf, ord. no. F BI 1340 00 00, load capacity: 130 kg

| ORD. NO.               | TYPE OF WORKTOP               | THICKNESS mm | LOAD CAP. kg |
|------------------------|-------------------------------|--------------|--------------|
| <b>F BI A542 10 04</b> | Multiplex                     | 50           | 1000         |
| <b>F BI A342 10 04</b> | Multiplex                     | 40           | 800          |
| <b>F BK A542 10 04</b> | 3 cross-glued layers          | 50           | 1000         |
| <b>F BH A342 10 04</b> | Grey laminate with solid wood | 40           | 800          |
| <b>F BH B342 10 04</b> | Grey laminate                 | 40           | 800          |

Bottom shelf, ord. no. F BI 1340 00 00, load capacity: 130 kg



| ORD. NO.               | TYPE OF WORKTOP               | THICKNESS mm | LOAD CAP. kg |
|------------------------|-------------------------------|--------------|--------------|
| <b>F BI A542 16 04</b> | Multiplex                     | 50           | 1500         |
| <b>F BI A342 16 04</b> | Multiplex                     | 40           | 1500         |
| <b>F BK A542 16 04</b> | 3 cross-glued layers          | 50           | 1500         |
| <b>F BH A342 16 04</b> | Grey laminate with solid wood | 40           | 1500         |
| <b>F BH B342 16 04</b> | Grey laminate                 | 40           | 1500         |

Bottom shelf, ord. no. F BI 0773 01 01, load capacity: 180 kg

| ORD. NO.               | TYPE OF WORKTOP               | THICKNESS mm | LOAD CAP. kg |
|------------------------|-------------------------------|--------------|--------------|
| <b>F BI A542 34 04</b> | Multiplex                     | 50           | 1500         |
| <b>F BI A342 34 04</b> | Multiplex                     | 40           | 1500         |
| <b>F BK A542 34 04</b> | 3 cross-glued layers          | 50           | 1500         |
| <b>F BH A342 34 04</b> | Grey laminate with solid wood | 40           | 1500         |
| <b>F BH B342 34 04</b> | Grey laminate                 | 40           | 1500         |

Bottom shelf, ord. no. F BI 0773 01 01, load capacity: 180 kg

KEY



- PE = Retractable shelf
- All indicated loads are net and refer to evenly distributed weights

RAL 7000 F. ....01 RAL 6011 F. ....02 RAL 5012 F. ....04 RAL 7035 F. ....08

■ Sets of partitions see page A72 - A73



## SERIES WORK 15-75

LENGTH = 1500 mm DEPTH = 750 mm (27x36 Eh)

## SHELVES 750 mm DEEP

| ORD. NO.               | TYPE OF WORKTOP               | THICKNESS mm | LOAD CAP. kg |
|------------------------|-------------------------------|--------------|--------------|
| <b>F BI A442 01 04</b> | Multiplex                     | 50           | 1000         |
| <b>F BI A242 01 04</b> | Multiplex                     | 40           | 800          |
| <b>F BK A442 01 04</b> | 3 cross-glued layers          | 50           | 1000         |
| <b>F BH A242 01 04</b> | Grey laminate with solid wood | 40           | 800          |
| <b>F BH B242 01 04</b> | Grey laminate                 | 40           | 800          |

Bottom shelf, ord. no. F BI 1340 00 00, load capacity: 130 kg



| ORD. NO.               | TYPE OF WORKTOP               | THICKNESS mm | LOAD CAP. kg |
|------------------------|-------------------------------|--------------|--------------|
| <b>F BI A442 04 04</b> | Multiplex                     | 50           | 1000         |
| <b>F BI A242 04 04</b> | Multiplex                     | 40           | 800          |
| <b>F BK A442 04 04</b> | 3 cross-glued layers          | 50           | 1000         |
| <b>F BH A242 04 04</b> | Grey laminate with solid wood | 40           | 800          |
| <b>F BH B242 04 04</b> | Grey laminate                 | 40           | 800          |

Bottom shelf, ord. no. F BI 1340 00 00, load capacity: 130 kg

| ORD. NO.               | TYPE OF WORKTOP               | THICKNESS mm | LOAD CAP. kg |
|------------------------|-------------------------------|--------------|--------------|
| <b>F BI A442 10 04</b> | Multiplex                     | 50           | 1000         |
| <b>F BI A242 10 04</b> | Multiplex                     | 40           | 800          |
| <b>F BK A442 10 04</b> | 3 cross-glued layers          | 50           | 1000         |
| <b>F BH A242 10 04</b> | Grey laminate with solid wood | 40           | 800          |
| <b>F BH B242 10 04</b> | Grey laminate                 | 40           | 800          |

Bottom shelf, ord. no. F BI 1340 00 00, load capacity: 130 kg



| ORD. NO.               | TYPE OF WORKTOP               | THICKNESS mm | LOAD CAP. kg |
|------------------------|-------------------------------|--------------|--------------|
| <b>F BI A442 16 04</b> | Multiplex                     | 50           | 1500         |
| <b>F BI A242 16 04</b> | Multiplex                     | 40           | 1500         |
| <b>F BK A442 16 04</b> | 3 cross-glued layers          | 50           | 1500         |
| <b>F BH A242 16 04</b> | Grey laminate with solid wood | 40           | 1500         |
| <b>F BH B242 16 04</b> | Grey laminate                 | 40           | 1500         |

Bottom shelf, ord. no. F BI 0773 01 01, load capacity: 180 kg

| ORD. NO.               | TYPE OF WORKTOP               | THICKNESS mm | LOAD CAP. kg |
|------------------------|-------------------------------|--------------|--------------|
| <b>F BI A442 34 04</b> | Multiplex                     | 50           | 1500         |
| <b>F BI A242 34 04</b> | Multiplex                     | 40           | 1500         |
| <b>F BK A442 34 04</b> | 3 cross-glued layers          | 50           | 1500         |
| <b>F BH A242 34 04</b> | Grey laminate with solid wood | 40           | 1500         |
| <b>F BH B242 34 04</b> | Grey laminate                 | 40           | 1500         |

Bottom shelf, ord. no. F BI 0773 01 01, load capacity: 180 kg

RAL 7000 F. ....01

RAL 6011 F. ....02

RAL 5012 F. ....04

RAL 7035 F. ....08

## KEY ■

■ Sets of partitions see page A72 - A73

- PE = Retractable shelf
- All indicated loads are net and refer to evenly distributed weights



LENGTH = 1500 mm DEPTH = 750 mm (27x36 Eh)

SERIES WORK 15



■ RAL 5012

**WORKSTATION****ORD. NO.****F BH A342 S1 04****Dimensions mm 1500x800x840/2110 h**

Tools, drawer partitioning sets and chair excluded

■ **INFO**

RAL 7000 F. ....01

RAL 6011 F. ....02

RAL 5012 F. ....04

RAL 7035 F. ....08

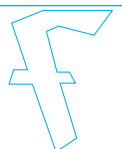
[www.famispa.com](http://www.famispa.com)



## SERIES WORK 20

LENGTH = 2000 mm DEPTH = 800 mm (27x36 Eh)



**ORD. NO. F BI G570 S1 04**  
RAL 5012

**WORKSTATION****ORD. NO.****F BI G570 S1 04**

Dimensions mm 2000x800x850/2120 h

Tools and drawer partitioning sets excluded

All the workbenches series WORK components are supplied without pre-drilling and bolts. To fix the components to the workbenches series WORK it is necessary to order the following **FIXING MATERIAL**:

**ORD. NO. F BL 9021 00 00**

For bench leg, adjustable bench leg, bench leg with wheels, cabinet with steel vice, bench leg for power fittings

**ORD. NO. F BL 9011 00 00**

Cabinets with shelves or doors

RAL 7000 F. ....01

RAL 6011 F. ....02

RAL 5012 F. ....04

RAL 7035 F. ....08

**SUPPLEMENTARY PARTS ■**

■ **Spare key.** Always indicate the number on the cylinder lock of the key to be replaced.

ORD. NO. R CSC 0002 00

■ **Master key.** This type of key opens all the 45 and 46 series locks.

ORD. NO. R CSC 0001 00



LENGTH = 2000 mm DEPTH = 800 mm (27x36 Eh)

SERIES WORK 20-80

SHELVES 800 mm DEEP

| ORD. NO.               | TYPE OF WORKTOP               | THICKNESS mm | LOAD CAP. kg |
|------------------------|-------------------------------|--------------|--------------|
| <b>F BI A570 01 04</b> | Multiplex                     | 50           | 700          |
| <b>F BI A370 01 04</b> | Multiplex                     | 40           | 500          |
| <b>F BK A570 01 04</b> | 3 cross-glued layers          | 50           | 700          |
| <b>F BH A370 01 04</b> | Grey laminate with solid wood | 40           | 500          |
| <b>F BH B370 01 04</b> | Grey laminate                 | 40           | 500          |

Bottom shelf, ord. no. F BI 1840 00 00, load capacity: 85 kg



| ORD. NO.               | TYPE OF WORKTOP               | THICKNESS mm | LOAD CAP. kg |
|------------------------|-------------------------------|--------------|--------------|
| <b>F BI A570 04 04</b> | Multiplex                     | 50           | 700          |
| <b>F BI A370 04 04</b> | Multiplex                     | 40           | 500          |
| <b>F BK A570 04 04</b> | 3 cross-glued layers          | 50           | 700          |
| <b>F BH A370 04 04</b> | Grey laminate with solid wood | 40           | 500          |
| <b>F BH B370 04 04</b> | Grey laminate                 | 40           | 500          |

Bottom shelf, ord. no. F BI 1840 00 00, load capacity: 85 kg

| ORD. NO.               | TYPE OF WORKTOP               | THICKNESS mm | LOAD CAP. kg |
|------------------------|-------------------------------|--------------|--------------|
| <b>F BI A570 10 04</b> | Multiplex                     | 50           | 700          |
| <b>F BI A370 10 04</b> | Multiplex                     | 40           | 500          |
| <b>F BK A570 10 04</b> | 3 cross-glued layers          | 50           | 700          |
| <b>F BH A370 10 04</b> | Grey laminate with solid wood | 40           | 500          |
| <b>F BH B370 10 04</b> | Grey laminate                 | 40           | 500          |

Bottom shelf, ord. no. F BI 1840 00 00, load capacity: 85 kg



| ORD. NO.               | TYPE OF WORKTOP               | THICKNESS mm | LOAD CAP. kg |
|------------------------|-------------------------------|--------------|--------------|
| <b>F BI A570 16 04</b> | Multiplex                     | 50           | 1000         |
| <b>F BI A370 16 04</b> | Multiplex                     | 40           | 800          |
| <b>F BK A570 16 04</b> | 3 cross-glued layers          | 50           | 1000         |
| <b>F BH A370 16 04</b> | Grey laminate with solid wood | 40           | 800          |
| <b>F BH B370 16 04</b> | Grey laminate                 | 40           | 800          |

Bottom shelf, ord. no. F BI 1275 01 01, load capacity: 130 kg

| ORD. NO.               | TYPE OF WORKTOP               | THICKNESS mm | LOAD CAP. kg |
|------------------------|-------------------------------|--------------|--------------|
| <b>F BI A570 40 04</b> | Multiplex                     | 50           | 1000         |
| <b>F BI A370 40 04</b> | Multiplex                     | 40           | 800          |
| <b>F BK A570 40 04</b> | 3 cross-glued layers          | 50           | 1000         |
| <b>F BH A370 40 04</b> | Grey laminate with solid wood | 40           | 800          |
| <b>F BH B370 40 04</b> | Grey laminate                 | 40           | 800          |

Bottom shelf, ord. no. F BI 1275 01 01, load capacity: 130 kg

KEY



- PE = Retractable shelf
- All indicated loads are net and refer to evenly distributed weights

RAL 7000 F. ....01 RAL 6011 F. ....02 RAL 5012 F. ....04 RAL 7035 F. ....08

■ Sets of partitions see page A72 - A73



## SERIES WORK 20-75

LENGTH = 2000 mm DEPTH = 750 mm (27x36 Eh)

## SHELVES 750 mm DEEP

| ORD. NO.               | TYPE OF WORKTOP               | THICKNESS mm | LOAD CAP. kg |
|------------------------|-------------------------------|--------------|--------------|
| <b>F BI A470 01 04</b> | Multiplex                     | 50           | 700          |
| <b>F BI A270 01 04</b> | Multiplex                     | 40           | 500          |
| <b>F BK A470 01 04</b> | 3 cross-glued layers          | 50           | 700          |
| <b>F BH A270 01 04</b> | Grey laminate with solid wood | 40           | 500          |
| <b>F BH B270 01 04</b> | Grey laminate                 | 40           | 500          |

Bottom shelf, ord. no. F BI 1840 00 00, load capacity: 85 kg



| ORD. NO.               | TYPE OF WORKTOP               | THICKNESS mm | LOAD CAP. kg |
|------------------------|-------------------------------|--------------|--------------|
| <b>F BI A470 04 04</b> | Multiplex                     | 50           | 700          |
| <b>F BI A270 04 04</b> | Multiplex                     | 40           | 500          |
| <b>F BK A470 04 04</b> | 3 cross-glued layers          | 50           | 700          |
| <b>F BH A270 04 04</b> | Grey laminate with solid wood | 40           | 500          |
| <b>F BH B270 04 04</b> | Grey laminate                 | 40           | 500          |

Bottom shelf, ord. no. F BI 1840 00 00, load capacity: 85 kg



| ORD. NO.               | TYPE OF WORKTOP               | THICKNESS mm | LOAD CAP. kg |
|------------------------|-------------------------------|--------------|--------------|
| <b>F BI A470 10 04</b> | Multiplex                     | 50           | 700          |
| <b>F BI A270 10 04</b> | Multiplex                     | 40           | 500          |
| <b>F BK A470 10 04</b> | 3 cross-glued layers          | 50           | 700          |
| <b>F BH A270 10 04</b> | Grey laminate with solid wood | 40           | 500          |
| <b>F BH B270 10 04</b> | Grey laminate                 | 40           | 500          |

Bottom shelf, ord. no. F BI 1840 00 00, load capacity: 85 kg



| ORD. NO.               | TYPE OF WORKTOP               | THICKNESS mm | LOAD CAP. kg |
|------------------------|-------------------------------|--------------|--------------|
| <b>F BI A470 16 04</b> | Multiplex                     | 50           | 1000         |
| <b>F BI A270 16 04</b> | Multiplex                     | 40           | 800          |
| <b>F BK A470 16 04</b> | 3 cross-glued layers          | 50           | 1000         |
| <b>F BH A270 16 04</b> | Grey laminate with solid wood | 40           | 800          |
| <b>F BH B270 16 04</b> | Grey laminate                 | 40           | 800          |

Bottom shelf, ord. no. F BI 1275 01 01, load capacity: 130 kg



| ORD. NO.               | TYPE OF WORKTOP               | THICKNESS mm | LOAD CAP. kg |
|------------------------|-------------------------------|--------------|--------------|
| <b>F BI A470 40 04</b> | Multiplex                     | 50           | 1000         |
| <b>F BI A270 40 04</b> | Multiplex                     | 40           | 800          |
| <b>F BK A470 40 04</b> | 3 cross-glued layers          | 50           | 1000         |
| <b>F BH A270 40 04</b> | Grey laminate with solid wood | 40           | 800          |
| <b>F BH B270 40 04</b> | Grey laminate                 | 40           | 800          |

Bottom shelf, ord. no. F BI 1275 01 01, load capacity: 130 kg

RAL 7000 F. ....01

RAL 6011 F. ....02

RAL 5012 F. ....04

RAL 7035 F. ....08

## KEY ■



■ Sets of partitions see page A72 - A73

- PE = Retractable shelf
- All indicated loads are net and refer to evenly distributed weights



LENGTH = 2000 mm DEPTH = 750 mm (27x36 Eh)

SERIES WORK 20



■ RAL 7035

**WORKSTATION****ORD. NO.****F BI B570 S1 08****Dimensions mm 2000x800x900 h**

Tools and drawer partitioning sets excluded

■ **INFO**

RAL 7000 F. ....01

RAL 6011 F. ....02

RAL 5012 F. ....04

RAL 7035 F. ....08

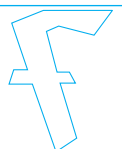
■ Sets of partitions see pages **A180**
[www.famispa.com](http://www.famispa.com)



## SERIES WORK 25

LENGTH = 2500 mm DEPTH = 800 mm (27x36 Eh)



**ORD. NO. F BI A584 S1 04**  
RAL 5012



## WORKSTATION

## ORD. NO.

F BI A584 S1 04

Dimensions mm 2500x800x750/1150 h

Tools and drawer partitioning sets excluded

All the workbenches series WORK components are supplied without pre-drilling and bolts. To fix the components to the workbenches series WORK it is necessary to order the following **FIXING MATERIAL**:

**ORD. NO. F BL 9021 00 00**

For bench leg, adjustable bench leg, bench leg with wheels, cabinet with steel vice, bench leg for power fittings

**ORD. NO. F BL 9011 00 00**

Cabinets with shelves or doors

RAL 7000 F. ....01

RAL 6011 F. ....02

RAL 5012 F. ....04

RAL 7035 F. ....08

## SUPPLEMENTARY PARTS ■

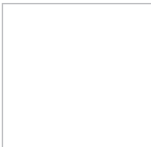
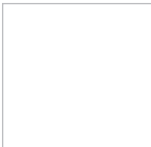

■ **Spare key.** Always indicate the number on the cylinder lock of the key to be replaced.

ORD. NO. R CSC 0002 00

■ **Master key.** This type of key opens all the 45 and 46 series locks.

ORD. NO. R CSC 0001 00



LENGTH = 2500 mm DEPTH = 800 mm (27x36 Eh)

SERIES WORK 25-80

SHELVES 800 mm DEEP



| ORD. NO.        | TYPE OF WORKTOP               | THICKNESS mm | LOAD CAP. kg |
|-----------------|-------------------------------|--------------|--------------|
| F BI A584 01 04 | Multiplex                     | 50           | 1000         |
| F BI A384 01 04 | Multiplex                     | 40           | 800          |
| F BK A584 01 04 | 3 cross-glued layers          | 50           | 1000         |
| F BH A384 01 04 | Grey laminate with solid wood | 40           | 800          |
| F BH B384 01 04 | Grey laminate                 | 40           | 800          |

Bottom shelf, ord. no. F BI 2100 00 00, load capacity: 260 kg



| ORD. NO.        | TYPE OF WORKTOP               | THICKNESS mm | LOAD CAP. kg |
|-----------------|-------------------------------|--------------|--------------|
| F BI A584 04 04 | Multiplex                     | 50           | 1000         |
| F BI A384 04 04 | Multiplex                     | 40           | 800          |
| F BK A584 04 04 | 3 cross-glued layers          | 50           | 1000         |
| F BH A384 04 04 | Grey laminate with solid wood | 40           | 800          |
| F BH B384 04 04 | Grey laminate                 | 40           | 800          |

Bottom shelf, ord. no. F BI 2100 00 00, load capacity: 260 kg

| ORD. NO.        | TYPE OF WORKTOP               | THICKNESS mm | LOAD CAP. kg |
|-----------------|-------------------------------|--------------|--------------|
| F BI A584 46 04 | Multiplex                     | 50           | 1000         |
| F BI A384 46 04 | Multiplex                     | 40           | 800          |
| F BK A584 46 04 | 3 cross-glued layers          | 50           | 1000         |
| F BH A384 46 04 | Grey laminate with solid wood | 40           | 800          |
| F BH B384 46 04 | Grey laminate                 | 40           | 800          |

Bottom shelf, ord. no. F BI 2110 01 01, load capacity: 260 kg



With 4 Schuko sockets 220-250V 10A 2P+GND and thermomagnetic switch 2P 230V AC 10A, cabled

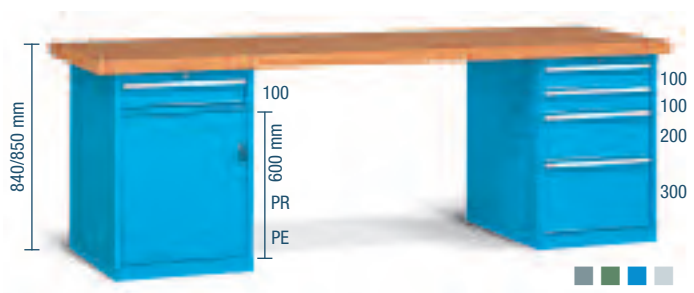

| ORD. NO.        | TYPE OF WORKTOP               | THICKNESS mm | LOAD CAP. kg |
|-----------------|-------------------------------|--------------|--------------|
| F BI A584 28 04 | Multiplex                     | 50           | 1000         |
| F BI A384 28 04 | Multiplex                     | 40           | 800          |
| F BK A584 28 04 | 3 cross-glued layers          | 50           | 1000         |
| F BH A384 28 04 | Grey laminate with solid wood | 40           | 800          |
| F BH B384 28 04 | Grey laminate                 | 40           | 800          |

Bottom shelf, ord. no. F BI 1210 02 01, load capacity: 130 kg

KEY



- PE = Retractable shelf ■ PR = Adjustable shelf
- All indicated loads are net and refer to evenly distributed weights

RAL 7000 F. ....01 RAL 6011 F. ....02 RAL 5012 F. ....04 RAL 7035 F. ....08

■ Sets of partitions see page A72 - A73



## SERIES WORK 25-75

LENGTH = 2500 mm DEPTH = 750 mm (27x36 Eh)

## SHELVES 750 mm DEEP

| ORD. NO.               | TYPE OF WORKTOP               | THICKNESS mm | LOAD CAP. kg |
|------------------------|-------------------------------|--------------|--------------|
| <b>F BI A484 01 04</b> | Multiplex                     | 50           | 1000         |
| <b>F BI A284 01 04</b> | Multiplex                     | 40           | 800          |
| <b>F BK A484 01 04</b> | 3 cross-glued layers          | 50           | 1000         |
| <b>F BH A284 01 04</b> | Grey laminate with solid wood | 40           | 800          |
| <b>F BH B284 01 04</b> | Grey laminate                 | 40           | 800          |

Bottom shelf, ord. no. F BI 2100 00 00, load capacity: 260 kg



| ORD. NO.               | TYPE OF WORKTOP               | THICKNESS mm | LOAD CAP. kg |
|------------------------|-------------------------------|--------------|--------------|
| <b>F BI A484 04 04</b> | Multiplex                     | 50           | 1000         |
| <b>F BI A284 04 04</b> | Multiplex                     | 40           | 800          |
| <b>F BK A484 04 04</b> | 3 cross-glued layers          | 50           | 1000         |
| <b>F BH A284 04 04</b> | Grey laminate with solid wood | 40           | 800          |
| <b>F BH B284 04 04</b> | Grey laminate                 | 40           | 800          |

Bottom shelf, ord. no. F BI 2100 00 00, load capacity: 260 kg

| ORD. NO.               | TYPE OF WORKTOP               | THICKNESS mm | LOAD CAP. kg |
|------------------------|-------------------------------|--------------|--------------|
| <b>F BI A484 46 04</b> | Multiplex                     | 50           | 1000         |
| <b>F BI A284 46 04</b> | Multiplex                     | 40           | 800          |
| <b>F BK A484 46 04</b> | 3 cross-glued layers          | 50           | 1000         |
| <b>F BH A284 46 04</b> | Grey laminate with solid wood | 40           | 800          |
| <b>F BH B284 46 04</b> | Grey laminate                 | 40           | 800          |

Bottom shelf, ord. no. F BI 2110 01 01, load capacity: 260 kg



With 4 Schuko sockets 220-250V 10A 2P+GND and thermomagnetic switch 2P 230V AC 10A, cabled



| ORD. NO.               | TYPE OF WORKTOP               | THICKNESS mm | LOAD CAP. kg |
|------------------------|-------------------------------|--------------|--------------|
| <b>F BI A484 28 04</b> | Multiplex                     | 50           | 1000         |
| <b>F BI A284 28 04</b> | Multiplex                     | 40           | 800          |
| <b>F BK A484 28 04</b> | 3 cross-glued layers          | 50           | 1000         |
| <b>F BH A284 28 04</b> | Grey laminate with solid wood | 40           | 800          |
| <b>F BH B284 28 04</b> | Grey laminate                 | 40           | 800          |

Bottom shelf, ord. no. F BI 1210 02 01, load capacity: 130 kg

RAL 7000 F. ....01 RAL 6011 F. ....02 RAL 5012 F. ....04 RAL 7035 F. ....08

## KEY ■

■ Sets of partitions see page A72 - A73

- PE = Retractable shelf
- PR = Adjustable shelf
- All indicated loads are net and refer to evenly distributed weights



LENGTH = 2500 mm DEPTH = 750 mm (27x36 Eh)

SERIES WORK 25



■ RAL 7035

**WORKSTATION**

**ORD. NO.**

**F BI A584 S2 08**

**Dimensions mm 2500x800x900 h**

Tools and drawer partitioning sets excluded

■ **INFO**

RAL 7000 F. ....01 RAL 6011 F. ....02 RAL 5012 F. ....04 RAL 7035 F. ....08

■ Sets of partitions see page A180



[www.famispa.com](http://www.famispa.com)





## SERIES WORK 30

LENGTH = 3000 mm DEPTH = 800 mm (27x36 Eh)

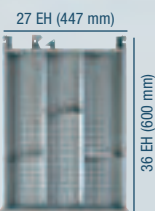

**ORD. NO. F BI A598 S1 04**  
RAL 5012

**WORKSTATION****ORD. NO.****F BI A598 S1 04**

Dimensions mm 3000x800x850/2120 h

Complete with multi-purpose back panels. Tools and set of partitioning material for drawers excluded.

All the workbenches series WORK components are supplied without pre-drilling and bolts. To fix the components to the workbenches series WORK it is necessary to order the following **FIXING MATERIAL**:

**ORD. NO. F BL 9021 00 00**

For bench leg, adjustable bench leg, bench leg with wheels, cabinet with steel vice, bench leg for power fittings

**ORD. NO. F BL 9011 00 00**

Cabinets with shelves or doors

RAL 7000 F. ....01

RAL 6011 F. ....02

RAL 5012 F. ....04

RAL 7035 F. ....08

**SUPPLEMENTARY PARTS ■**

■ **Spare key.** Always indicate the number on the cylinder lock of the key to be replaced.

ORD. NO. R CSC 0002 00

■ **Master key.** This type of key opens all the 45 and 46 series locks.

ORD. NO. R CSC 0001 00



LENGTH = 3000 mm DEPTH = 800 mm (27x36 Eh)

SERIES WORK 30-80

SHELVES 800 mm DEEP

| ORD. NO.               | TYPE OF WORKTOP               | THICKNESS mm | LOAD CAP. kg |
|------------------------|-------------------------------|--------------|--------------|
| <b>F BI A598 01 04</b> | Multiplex                     | 50           | 800          |
| <b>F BK A598 01 04</b> | 3 cross-glued layers          | 50           | 800          |
| <b>F BH A598 01 04</b> | Grey laminate with solid wood | 50           | 800          |
| <b>F BH B598 01 04</b> | Grey laminate                 | 50           | 800          |

Bottom shelf, ord. no. F BI 2690 00 00, load capacity: 210 kg



| ORD. NO.               | TYPE OF WORKTOP               | THICKNESS mm | LOAD CAP. kg |
|------------------------|-------------------------------|--------------|--------------|
| <b>F BI A598 04 04</b> | Multiplex                     | 50           | 800          |
| <b>F BK A598 04 04</b> | 3 cross-glued layers          | 50           | 800          |
| <b>F BH A598 04 04</b> | Grey laminate with solid wood | 50           | 800          |
| <b>F BH B598 04 04</b> | Grey laminate                 | 50           | 800          |

Bottom shelf, ord. no. F BI 2690 00 00, load capacity: 210 kg

| ORD. NO.               | TYPE OF WORKTOP               | THICKNESS mm | LOAD CAP. kg |
|------------------------|-------------------------------|--------------|--------------|
| <b>F BI A598 22 04</b> | Multiplex                     | 50           | 800          |
| <b>F BK A598 22 04</b> | 3 cross-glued layers          | 50           | 800          |
| <b>F BH A598 22 04</b> | Grey laminate with solid wood | 50           | 800          |
| <b>F BH B598 22 04</b> | Grey laminate                 | 50           | 800          |

Bottom shelf, ord. no. F BI 2510 01 01, load capacity: 210 kg

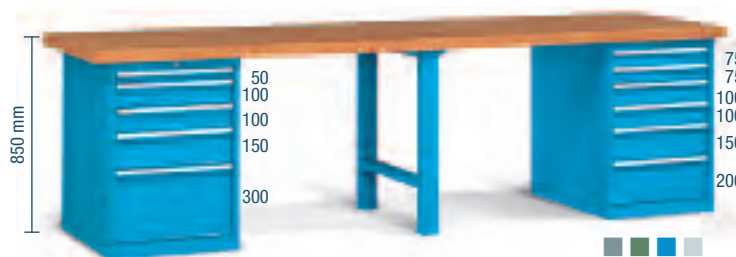

| ORD. NO.               | TYPE OF WORKTOP               | THICKNESS mm | LOAD CAP. kg |
|------------------------|-------------------------------|--------------|--------------|
| <b>F BI A598 16 04</b> | Multiplex                     | 50           | 1500         |
| <b>F BK A598 16 04</b> | Multiplex                     | 50           | 1500         |
| <b>F BH A598 16 04</b> | 3 cross-glued layers          | 50           | 1500         |
| <b>F BH B598 16 04</b> | Grey laminate with solid wood | 50           | 1500         |

Bottom shelf, ord. no. F BI 1710 02 01, load capacity: 360 kg

KEY



- PE = Retractable shelf
- All indicated loads are net and refer to evenly distributed weights

RAL 7000 F. ....01 RAL 6011 F. ....02 RAL 5012 F. ....04 RAL 7035 F. ....08

■ Sets of partitions see page A72 - A73



LENGTH = 3000 mm DEPTH = 750 mm (27x36 Eh)

SERIES WORK 30-75

SHELVES 750 mm DEEP

| ORD. NO.               | TYPE OF WORKTOP               | THICKNESS mm | LOAD CAP. kg |
|------------------------|-------------------------------|--------------|--------------|
| <b>F BI A498 01 04</b> | Multiplex                     | 50           | 800          |
| <b>F BK A498 01 04</b> | 3 cross-glued layers          | 50           | 800          |
| <b>F BH A498 01 04</b> | Grey laminate with solid wood | 50           | 800          |
| <b>F BH B498 01 04</b> | Grey laminate                 | 50           | 800          |

Bottom shelf, ord. no. F BI 2690 00 00, load capacity: 210 kg



| ORD. NO.               | TYPE OF WORKTOP               | THICKNESS mm | LOAD CAP. kg |
|------------------------|-------------------------------|--------------|--------------|
| <b>F BI A498 04 04</b> | Multiplex                     | 50           | 800          |
| <b>F BK A498 04 04</b> | 3 cross-glued layers          | 50           | 800          |
| <b>F BH A498 04 04</b> | Grey laminate with solid wood | 50           | 800          |
| <b>F BH B498 04 04</b> | Grey laminate                 | 50           | 800          |

Bottom shelf, ord. no. F BI 2690 00 00, load capacity: 210 kg

| ORD. NO.               | TYPE OF WORKTOP               | THICKNESS mm | LOAD CAP. kg |
|------------------------|-------------------------------|--------------|--------------|
| <b>F BI A498 22 04</b> | Multiplex                     | 50           | 800          |
| <b>F BK A498 22 04</b> | 3 cross-glued layers          | 50           | 800          |
| <b>F BH A498 22 04</b> | Grey laminate with solid wood | 50           | 800          |
| <b>F BH B498 22 04</b> | Grey laminate                 | 50           | 800          |

Bottom shelf, ord. no. F BI 2510 01 01, load capacity: 210 kg

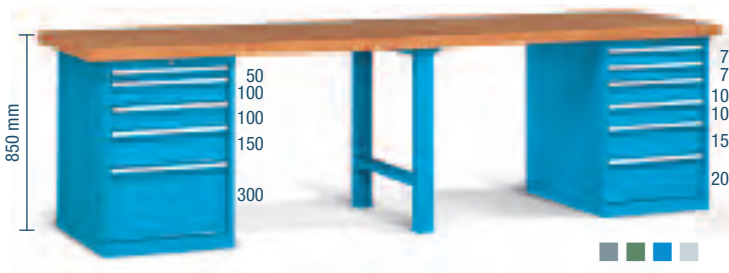

| ORD. NO.               | TYPE OF WORKTOP               | THICKNESS mm | LOAD CAP. kg |
|------------------------|-------------------------------|--------------|--------------|
| <b>F BI A498 16 04</b> | Multiplex                     | 50           | 1500         |
| <b>F BK A498 16 04</b> | Multiplex                     | 50           | 1500         |
| <b>F BH A498 16 04</b> | 3 cross-glued layers          | 50           | 1500         |
| <b>F BH B498 16 04</b> | Grey laminate with solid wood | 50           | 1500         |

Bottom shelf, ord. no. F BI 1710 02 01, load capacity: 360 kg

RAL 7000 F. ....01 RAL 6011 F. ....02 RAL 5012 F. ....04 RAL 7035 F. ....08

KEY ■

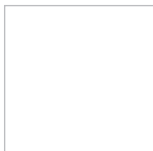

■ Sets of partitions see page A72 - A73

- PE = Retractable shelf ■ PR = Adjustable shelf
- All indicated loads are net and refer to evenly distributed weights



LENGTH = 3000 mm DEPTH = 750 mm (27x36 Eh)

SERIES WORK 30

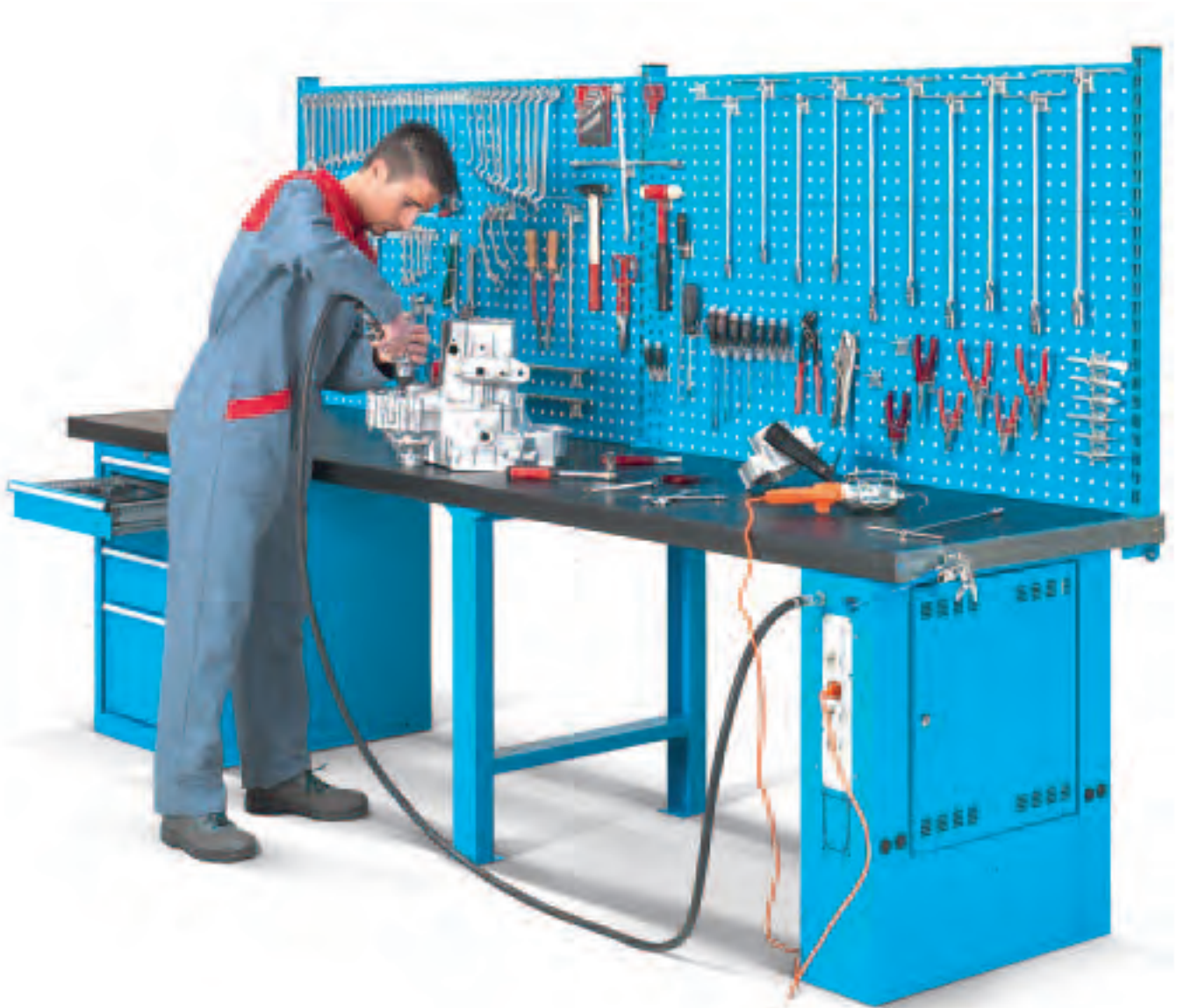

■ RAL 5012

**WORKSTATION****ORD. NO.****F BI G598 S1 04****Dimensions mm 3000x800x900/1830 h**

Tools and set of partitioning material for drawers excluded

■ **INFO**

RAL 7000 F. ....01

RAL 6011 F. ....02

RAL 5012 F. ....04

RAL 7035 F. ....08

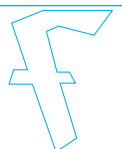

[www.famispa.com](http://www.famispa.com)



## SERIES WORK-ROL

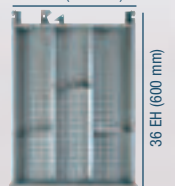

27 EH (447 mm)



All the workbenches series WORK components are supplied without pre-drilling and bolts. To fix the components to the workbenches series WORK it is necessary to order the following **FIXING MATERIAL**:

**ORD. NO. F BL 9021 00 00**

For bench leg, adjustable bench leg, bench leg with wheels, cabinet with steel vice, bench leg for power fittings

**ORD. NO. F BL 9011 00 00**

Cabinets with shelves or doors

RAL 7000 F. ....01

RAL 6011 F. ....02

RAL 5012 F. ....04

RAL 7035 F. ....08

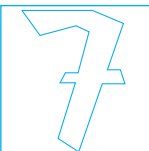
**SUPPLEMENTARY PARTS ■**

■ **Spare key.** Always indicate the number on the cylinder lock of the key to be replaced.

ORD. NO. R CSC 0002 00

■ **Master key.** This type of key opens all the 45 and 46 series locks.

ORD. NO. R CSC 0001 00



LENGTH = 1300 mm DEPTH = 800 mm (27x36 Eh)

## SERIES WORK-ROL

## BACK AND SIDE UPSTAND OF MULTIPLEX

## SIDE UPSTAND OF MULTIPLEX

| ORD. NO.        | DIM. mm      | FOR WORKSTATION |
|-----------------|--------------|-----------------|
| F BL 5610 00 00 | 762x12x100 h | 750 mm          |
| F BL 5635 00 00 | 770x20x150 h | 750 mm          |
| F BL 5645 00 00 | 770x20x200 h | 750 mm          |
| F BL 5630 00 00 | 812x12x100 h | 800 mm          |
| F BL 5640 00 00 | 820x20x150 h | 800 mm          |
| F BL 5650 00 00 | 820x20x200 h | 800 mm          |

## BACK UPSTAND OF MULTIPLEX

| ORD. NO.        | DIM. mm       | FOR WORKSTATION |
|-----------------|---------------|-----------------|
| F BL 5720 00 00 | 1300x12x100 h | 1300 mm         |
| F BL 5790 00 00 | 1300x20x150 h | 1300 mm         |
| F BL 5860 00 00 | 1300x20x200 h | 1300 mm         |
| F BL 5730 00 00 | 1500x12x100 h | 1500 mm         |
| F BL 5800 00 00 | 1500x20x150 h | 1500 mm         |
| F BL 5870 00 00 | 1500x20x200 h | 1500 mm         |
| F BL 5750 00 00 | 2000x12x100 h | 2000 mm         |
| F BL 5820 00 00 | 2000x20x150 h | 2000 mm         |
| F BL 5890 00 00 | 2000x20x200 h | 2000 mm         |

## ORD. NO.

## F CA C328 S1 04

Complete with upstands and vice

Dimensions mm 1350x820x1000 h

Tools and drawer partitioning sets excluded



■ RAL 5012

■ RAL 7000+  
■ RAL 5012



■ Mobile workstations FLEXA see page A38 - A51

## ■ INFO

RAL 7000 F. ....01

RAL 6011 F. ....02

RAL 5012 F. ....04

RAL 7035 F. ....08



[www.famispa.com](http://www.famispa.com)



LENGTH = 1300 mm DEPTH = 750 mm (27x36 Eh)

SERIES WORK-ROL 13-80

SHELVES 800 mm DEEP



| ORD. NO.               | TYPE OF WHEEL   | THICKNESS mm | Ø mm | LOAD CAP. kg |
|------------------------|-----------------|--------------|------|--------------|
| <b>F CC C328 13 04</b> | Standard rubber | 40           | 125  | 220          |
| <b>F CC Q328 13 04</b> | Nylon           | 40           | 125  | 500          |

- Complete with:
- 2 braked swivel wheels Ø 125 mm
  - 2 fixed wheels Ø 125 mm
  - 3 normal extension drawers
  - 1 bench leg with power fittings
  - 1 electrical system
  - 1 pneumatic system

Dimensions mm 1330x800x890 h

| ORD. NO.               | TYPE OF WHEEL   | THICKNESS mm | Ø mm | LOAD CAP. kg |
|------------------------|-----------------|--------------|------|--------------|
| <b>F CC C328 14 04</b> | Standard rubber | 40           | 125  | 220          |
| <b>F CC Q328 14 04</b> | Nylon           | 40           | 125  | 500          |

- Complete with:
- 2 braked swivel wheels, 2 fixed wheels Ø 125 mm
  - 3 normal extension drawers
  - 1 roller shutter cabinet with 1 set of 16 hooks (tools excluded)
  - 2 support columns with dual slots, 1 perforated back panel
  - 1 2x18W lighting system and 1 bench leg with power fittings
  - 1 electrical system, 1 pneumatic system

Dimensions mm 1330x800x2160 h



■ Mobile workstations FLEXA see page A38 - A51

■ RAL 7035+  
■ RAL 5012

RAL 7000 F. ....01 RAL 6011 F. ....02 RAL 5012 F. ....04 RAL 7035 F. ....08

KEY ■

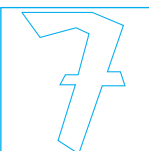

■ Sets of partitions see page A72 - A73

■ All indicated loads are net and refer to evenly distributed weights



## SHELVES 800 mm DEEP

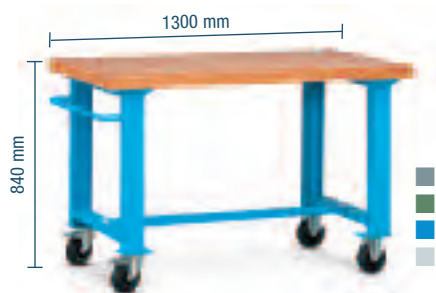

| ORD. NO.                        | TYPE OF WHEEL   | THICKNESS mm | Ø mm | LOAD CAP. kg |
|---------------------------------|-----------------|--------------|------|--------------|
| <b>F CA C328 02 04</b>          | Standard rubber | 40           | 125  | 240          |
| <b>F CA Q328 02 04</b>          | Nylon           | 40           | 125  | 600          |
| Complete with:                  |                 |              |      |              |
| 2 braked swivel wheels Ø 125 mm |                 |              |      |              |
| 2 fixed wheels Ø 125 mm         |                 |              |      |              |
| Dimensions mm 1330x800x840 h    |                 |              |      |              |

## SHELVES 750 mm DEEP

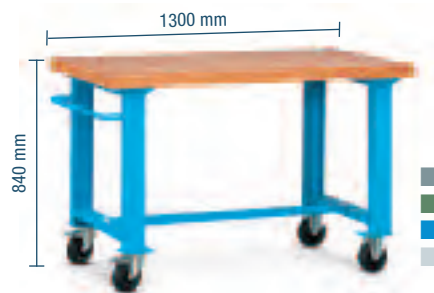

| ORD. NO.                        | TYPE OF WHEEL   | THICKNESS mm | Ø mm | LOAD CAP. kg |
|---------------------------------|-----------------|--------------|------|--------------|
| <b>F CA C228 02 04</b>          | Standard rubber | 40           | 125  | 240          |
| <b>F CA Q228 02 04</b>          | Nylon           | 40           | 125  | 600          |
| Complete with:                  |                 |              |      |              |
| 2 braked swivel wheels Ø 125 mm |                 |              |      |              |
| 2 fixed wheels Ø 125 mm         |                 |              |      |              |
| Dimensions mm 1330x750x840 h    |                 |              |      |              |

## SHELVES 800 mm DEEP



| ORD. NO.                        | TYPE OF WHEEL   | THICKNESS mm | Ø mm | LOAD CAP. kg |
|---------------------------------|-----------------|--------------|------|--------------|
| <b>F CA C328 03 04</b>          | Standard rubber | 40           | 125  | 220          |
| <b>F CA Q328 03 04</b>          | Nylon           | 40           | 125  | 600          |
| Complete with:                  |                 |              |      |              |
| 2 braked swivel wheels Ø 125 mm |                 |              |      |              |
| 2 fixed wheels Ø 125 mm         |                 |              |      |              |
| Dimensions mm 1330x800x840 h    |                 |              |      |              |

## SHELVES 750 mm DEEP



| ORD. NO.                        | TYPE OF WHEEL   | THICKNESS mm | Ø mm | LOAD CAP. kg |
|---------------------------------|-----------------|--------------|------|--------------|
| <b>F CA C228 03 04</b>          | Standard rubber | 40           | 125  | 220          |
| <b>F CA Q228 03 04</b>          | Nylon           | 40           | 125  | 600          |
| Complete with:                  |                 |              |      |              |
| 2 braked swivel wheels Ø 125 mm |                 |              |      |              |
| 2 fixed wheels Ø 125 mm         |                 |              |      |              |
| Dimensions mm 1330x750x840 h    |                 |              |      |              |

## KEY

RAL 7000 F. ....01

RAL 6011 F. ....02

RAL 5012 F. ....04

RAL 7035 F. ....08



- Sets of partitions see page A72 - A73
- All indicated loads are net and refer to evenly distributed weights





LENGTH = 1500 mm DEPTH = 800/750 mm (27x36 Eh)

SERIES WORK-ROL 15-80/15-75

SHELVES 800 mm DEEP



| ORD. NO.   | TYPE OF WHEEL   | THICKNESS mm | Ø mm | LOAD CAP. kg |
|--|-----------------|--------------|------|--------------|
| <b>F CA C342 02 04</b>   | Standard rubber | 40           | 125  | 240          |
| <b>F CA Q342 02 04</b>   | Nylon           | 40           | 125  | 600          |
| Complete with: 2 braked swivel wheels, 2 fixed wheels Ø 125 mm |                 |              |      |              |
| Dimensions mm 1530x800x840 h                                   |                 |              |      |              |

SHELVES 750 mm DEEP

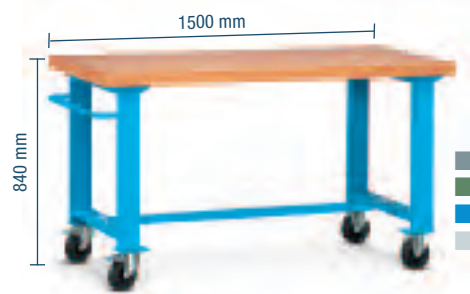

| ORD. NO.   | TYPE OF WHEEL   | THICKNESS mm | Ø mm | LOAD CAP. kg |
|--|-----------------|--------------|------|--------------|
| <b>F CA C242 02 04</b>   | Standard rubber | 40           | 125  | 240          |
| <b>F CA Q242 02 04</b>   | Nylon           | 40           | 125  | 600          |
| Complete with: 2 braked swivel wheels, 2 fixed wheels Ø 125 mm |                 |              |      |              |
| Dimensions mm 1530x750x840 h                                   |                 |              |      |              |

SHELVES 800 mm DEEP



| ORD. NO.   | TYPE OF WHEEL   | THICKNESS mm | Ø mm | LOAD CAP. kg |
|--|-----------------|--------------|------|--------------|
| <b>F CA C342 04 04</b>   | Standard rubber | 40           | 125  | 200          |
| <b>F CA Q342 04 04</b>   | Nylon           | 40           | 125  | 600          |
| Complete with: 2 braked swivel wheels, 2 fixed wheels Ø 125 mm |                 |              |      |              |
| Dimensions mm 1530x800x840 h                                   |                 |              |      |              |

SHELVES 750 mm DEEP



| ORD. NO.   | TYPE OF WHEEL   | THICKNESS mm | Ø mm | LOAD CAP. kg |
|--|-----------------|--------------|------|--------------|
| <b>F CA C242 04 04</b>   | Standard rubber | 40           | 125  | 200          |
| <b>F CA Q242 04 04</b>   | Nylon           | 40           | 125  | 600          |
| Complete with: 2 braked swivel wheels, 2 fixed wheels Ø 125 mm |                 |              |      |              |
| Dimensions mm 1530x750x840 h                                   |                 |              |      |              |

SHELVES 800 mm DEEP



| ORD. NO.   | TYPE OF WHEEL   | THICKNESS mm | Ø mm | LOAD CAP. kg |
|--|-----------------|--------------|------|--------------|
| <b>F CA C342 05 04</b>   | Standard rubber | 40           | 125  | 240          |
| <b>F CA Q342 05 04</b>   | Nylon           | 40           | 125  | 600          |
| Complete with: 2 braked swivel wheels, 2 fixed wheels Ø 125 mm |                 |              |      |              |
| Dimensions mm 1530x800x895/1295 h                              |                 |              |      |              |

SHELVES 750 mm DEEP



| ORD. NO.   | TYPE OF WHEEL   | THICKNESS mm | Ø mm | LOAD CAP. kg |
|--|-----------------|--------------|------|--------------|
| <b>F CA C242 05 04</b>   | Standard rubber | 40           | 125  | 240          |
| <b>F CA Q242 05 04</b>   | Nylon           | 40           | 125  | 600          |
| Complete with: 2 braked swivel wheels, 2 fixed wheels Ø 125 mm |                 |              |      |              |
| Dimensions mm 1530x750x895/1295 h                              |                 |              |      |              |

RAL 7000 F. ....01 RAL 6011 F. ....02 RAL 5012 F. ....04 RAL 7035 F. ....08

KEY ■

- Sets of partitions see page A72 - A73
- All indicated loads are net and refer to evenly distributed weights



LENGTH = 2000 mm DEPTH = 800/750 mm (27x36 Eh)

## SERIES WORK-ROL 20-80/20-75

## SHELVES 800 mm DEEP

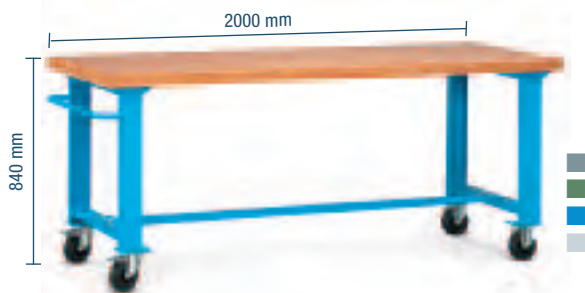

| ORD. NO.   | TYPE OF WHEEL   | THICKNESS mm | Ø mm | LOAD CAP. kg |
|--|-----------------|--------------|------|--------------|
| <b>F CA C370 02 04</b>   | Standard rubber | 40           | 125  | 220          |
| <b>F CA Q370 02 04</b>   | Nylon           | 40           | 125  | 500          |
| Complete with: 2 braked swivel wheels, 2 fixed wheels Ø 125 mm |                 |              |      |              |
| Dimensions mm 2030x800x840 h                                   |                 |              |      |              |

## SHELVES 750 mm DEEP

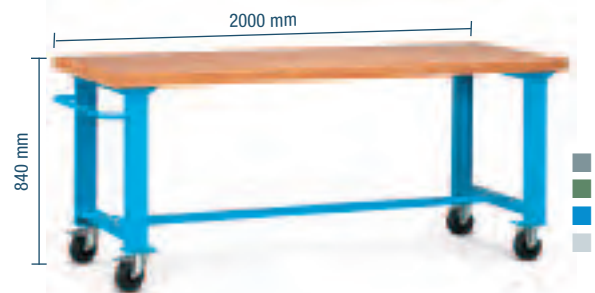

| ORD. NO.   | TYPE OF WHEEL   | THICKNESS mm | Ø mm | LOAD CAP. kg |
|--|-----------------|--------------|------|--------------|
| <b>F CA C270 02 04</b>   | Standard rubber | 40           | 125  | 220          |
| <b>F CA Q270 02 04</b>   | Nylon           | 40           | 125  | 500          |
| Complete with: 2 braked swivel wheels, 2 fixed wheels Ø 125 mm |                 |              |      |              |
| Dimensions mm 2030x750x840 h                                   |                 |              |      |              |

## SHELVES 800 mm DEEP

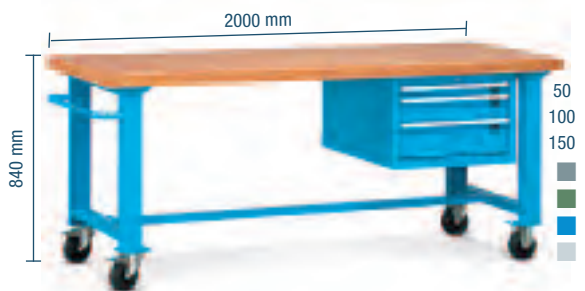

| ORD. NO.   | TYPE OF WHEEL   | THICKNESS mm | Ø mm | LOAD CAP. kg |
|--|-----------------|--------------|------|--------------|
| <b>F CA C370 04 04</b>   | Standard rubber | 40           | 125  | 180          |
| <b>F CA Q370 04 04</b>   | Nylon           | 40           | 125  | 500          |
| Complete with: 2 braked swivel wheels, 2 fixed wheels Ø 125 mm |                 |              |      |              |
| Dimensions mm 2030x800x840 h                                   |                 |              |      |              |

## SHELVES 750 mm DEEP

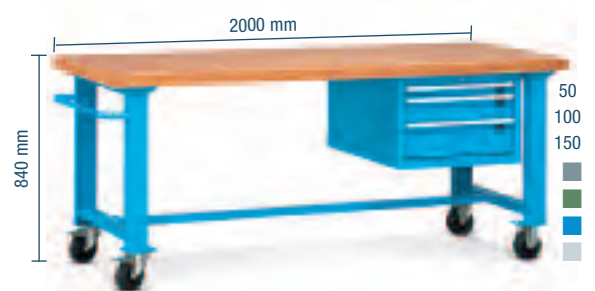

| ORD. NO.   | TYPE OF WHEEL   | THICKNESS mm | Ø mm | LOAD CAP. kg |
|--|-----------------|--------------|------|--------------|
| <b>F CA C270 04 04</b>   | Standard rubber | 40           | 125  | 180          |
| <b>F CA Q270 04 04</b>   | Nylon           | 40           | 125  | 500          |
| Complete with: 2 braked swivel wheels, 2 fixed wheels Ø 125 mm |                 |              |      |              |
| Dimensions mm 2030x750x840 h                                   |                 |              |      |              |

## SHELVES 800 mm DEEP

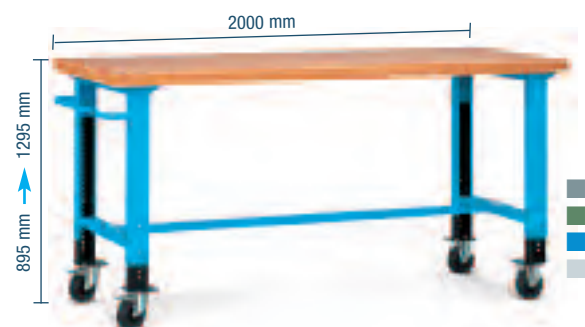

| ORD. NO.   | TYPE OF WHEEL   | THICKNESS mm | Ø mm | LOAD CAP. kg |
|--|-----------------|--------------|------|--------------|
| <b>F CA C370 05 04</b>   | Standard rubber | 40           | 125  | 220          |
| <b>F CA Q370 05 04</b>   | Nylon           | 40           | 125  | 500          |
| Complete with: 2 braked swivel wheels, 2 fixed wheels Ø 125 mm |                 |              |      |              |
| Dimensions mm 2030x800x895/1295 h                              |                 |              |      |              |

## SHELVES 750 mm DEEP

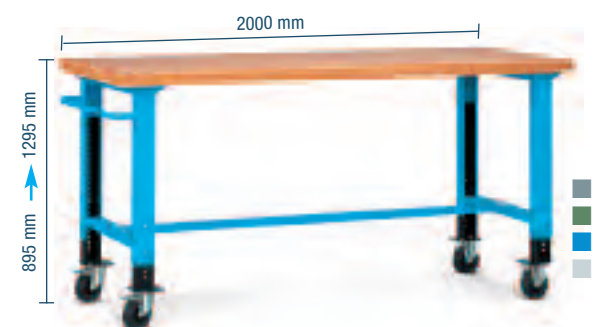

| ORD. NO.   | TYPE OF WHEEL   | THICKNESS mm | Ø mm | LOAD CAP. kg |
|--|-----------------|--------------|------|--------------|
| <b>F CA C270 05 04</b>   | Standard rubber | 40           | 125  | 220          |
| <b>F CA Q270 05 04</b>   | Nylon           | 40           | 125  | 500          |
| Complete with: 2 braked swivel wheels, 2 fixed wheels Ø 125 mm |                 |              |      |              |
| Dimensions mm 2030x750x895/1295 h                              |                 |              |      |              |

## KEY

RAL 7000 F. ....01 RAL 6011 F. ....02 RAL 5012 F. ....04 RAL 7035 F. ....08



- Sets of partitions see page A72 - A73
- All indicated loads are net and refer to evenly distributed weights

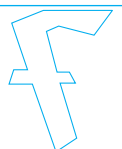

SERIES WORK

BENCH LEGS

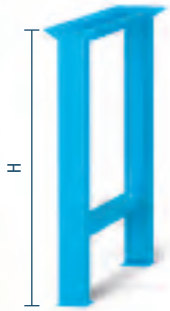

| ORD. NO.        | DIM. mm      |
|-----------------|--------------|
| F BL 6010 00 04 | 80x715x700 h |
| F BL 6025 00 04 | 80x715x800 h |
| F BL 6035 00 04 | 80x715x830 h |
| F BL 6040 00 04 | 80x715x850 h |

■ 01 ■ 02 ■ 04 ■ 08

ADJUSTABLE BENCH LEGS

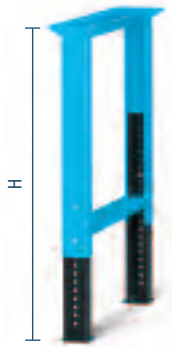

| ORD. NO.        | DIM. mm           |
|-----------------|-------------------|
| F BL 6045 00 58 | 80x715x700/1100 h |

■ 57 ■ 60 ■ 58 ■ 59

BENCH LEGS WITH WHEELS

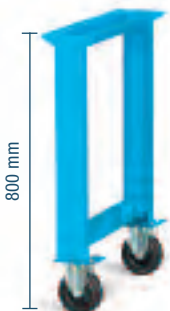

| ORD. NO.        | TYPE OF WHEEL   | Ø mm |
|-----------------|-----------------|------|
| F BL 6075 A0 04 | Standard rubber | 125  |
| F BL 6075 G0 04 | No-smear        | 125  |
| F BL 6075 D0 04 | Elastic rubber  | 125  |
| F BL 6075 K0 04 | Polyurethane    | 125  |
| F BL 6075 N0 04 | Nylon           | 125  |

Complete with: 2 fixed wheels Ø125 mm

■ 01 ■ 02 ■ 04 ■ 08

BENCH LEGS WITH WHEELS



| ORD. NO.        | TYPE OF WHEEL   | Ø mm |
|-----------------|-----------------|------|
| F BL 6090 C0 04 | Standard rubber | 125  |
| F BL 6090 I0 04 | No-smear        | 125  |
| F BL 6090 F0 04 | Elastic rubber  | 125  |
| F BL 6090 M0 04 | Polyurethane    | 125  |
| F BL 6090 Q0 04 | Nylon           | 125  |

Complete with: 2 braked swivel wheels Ø125 mm

■ 01 ■ 02 ■ 04 ■ 08

ADJUSTABLE BENCH LEGS WITH WHEELS



| ORD. NO.        | TYPE OF WHEEL   | Ø mm |
|-----------------|-----------------|------|
| F BL 6055 A0 58 | Standard rubber | 125  |
| F BL 6055 G0 58 | No-smear        | 125  |
| F BL 6055 D0 58 | Elastic rubber  | 125  |
| F BL 6055 K0 58 | Polyurethane    | 125  |
| F BL 6055 N0 58 | Nylon           | 125  |

Complete with: 2 fixed wheels Ø125 mm

■ 57 ■ 60 ■ 58 ■ 59

ADJUSTABLE BENCH LEGS WITH WHEELS



| ORD. NO.        | TYPE OF WHEEL   | Ø mm |
|-----------------|-----------------|------|
| F BL 6056 C0 58 | Standard rubber | 125  |
| F BL 6056 I0 58 | No-smear        | 125  |
| F BL 6056 F0 58 | Elastic rubber  | 125  |
| F BL 6056 M0 58 | Polyurethane    | 125  |
| F BL 6056 Q0 58 | Nylon           | 125  |

Complete with: 2 braked swivel wheels Ø125 mm

■ 57 ■ 60 ■ 58 ■ 59

CONNECTION PIECE FOR MOBILE WORKSTATION



■ 01 ■ 02 ■ 04 ■ 08

ORD. NO. CONNECTION PIECE FOR WORKSTATION LENGTH mm

F BL 6605 00 04 980 mm 1300

ORD. NO. CONNECTION PIECE FOR WORKSTATION LENGTH mm

F BL 6610 00 04 1180 mm 1500

ORD. NO. CONNECTION PIECE FOR WORKSTATION LENGTH mm

F BL 6620 00 04 1680 mm 2000

BENCH LEG WITH POWER FITTINGS

| ORD. NO.        | DIM. mm       |
|-----------------|---------------|
| F BL 6120 01 04 | 190x695x700 h |
| F BL 6125 01 04 | 190x695x800 h |
| F BL 6130 01 04 | 190x695x830 h |
| F BL 6135 01 04 | 190x695x850 h |

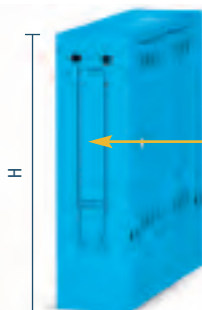

Electrical and pneumatic system see page C31.



■ 01 ■ 02 ■ 04 ■ 08

DEPTH = 726 mm (27x36 Eh)

SERIES WORK

**PNEUMATIC SYSTEM WITH SINGLE WINDER AND FILTER**

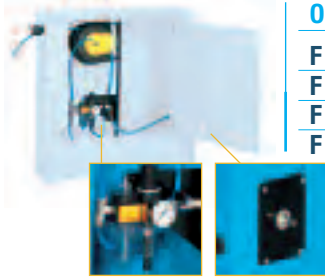

| ORD. NO.        | BENCH LEG HEIGHT mm |
|-----------------|---------------------|
| F BL 9670 70 07 | 700                 |
| F BL 9670 80 07 | 800                 |
| F BL 9670 83 07 | 830                 |
| F BL 9670 85 07 | 850                 |

Detail of fixed rear outlet

Detail of fixed reducer assembly with lubricator on request

**The pneumatic system includes:**

- 1 fix rear inlet with Ø 10 mm hose and connector (1/4") with pin (Ø 9–12 mm) used to link up to the pneumatic supply by means of an extension hose (not supplied standard).
- 1 front winder including 4 metres of hose with an internal diameter of 5,5 and a 1/4" threaded tool connector, capacity approx. 9 litres per second\*.
- 1 fixed front outlet with Ø 10 mm hose and 1/4" threaded connector complete with plug, capacity approx. 11 litres per second\*.
- 1 filter reducer assembly with pressure gauge which can be used at maximum pressure of 10 bar, capacity approx. 11 metres per second\* at an operating pressure of 6.3 bar.

\*capacity can vary according to the technical characteristics of the pneumatic supply to which the system is connected.

**PNEUMATIC SYSTEM WITH SINGLE WINDER**

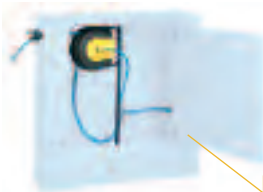

| ORD. NO.        | BENCH LEG HEIGHT mm |
|-----------------|---------------------|
| F BL 9660 70 07 | 700                 |
| F BL 9660 80 07 | 800                 |
| F BL 9660 83 07 | 830                 |
| F BL 9660 85 07 | 850                 |

Applicable on bench leg for power fittings only



Detail of fixed rear outlet

**The pneumatic system includes:**

- 1 fix rear inlet with Ø 10 mm hose and connector (3/8") with pin (Ø 9–12 mm) used to link up to the pneumatic supply by means of an extension hose (not supplied standard).
- 1 front winder including 4 metres of hose with an internal diameter of 5,5 and a 1/4" threaded tool connector.
- 1 fixed front outlet with Ø 10 mm hose and 3/8" threaded connector complete with plug.

**N.B.** All the unions (except for those of the winder) are 3/8".

**ELECTRIC SYSTEM**



The bench legs for power fittings are supplied standard with a side door with a cylinder lock and 2 keys. An electric and/or a pneumatic system can be fitted in these bench legs. The socket box is also fitted standard with a thermo-magnetic switch 2P 230V AC 10A and is connected (with a hard-wearing cable sheath) to a heavy duty socket 220-240V 16A 2P+GND at the rear featuring a vertically sliding cover. The system is protected to IP30.

| ORD. NO.        | type and number of cabled sockets: |   |    |   |    |    |
|-----------------|------------------------------------|---|----|---|----|----|
|                 | D                                  | F | GB | I | CH | IL |
| F BL 9620 10 00 | 4                                  | - | -  | - | -  | -  |
| F BL 9620 20 00 | -                                  | 4 | -  | - | -  | -  |
| F BL 9620 30 00 | -                                  | - | 3  | - | -  | -  |
| F BL 9620 40 00 | -                                  | - | -  | 4 | -  | -  |
| F BL 9620 50 00 | -                                  | - | -  | - | 4  | -  |
| F BL 9620 70 00 | -                                  | - | -  | - | -  | 4  |

**The electric system** includes a multiple socket box featuring 6 type of sockets:

- 4 sockets for large and small italian plugs 220-250V 10A 2P+GND
- 4 Schuko sockets 220-250V 10A 2P+GND
- 4 French sockets 220-250V 10A 2P+GND
- 3 British sockets 220-250V 10A 2P+GND
- 4 Swiss sockets 220-250V 10A 2P+GND
- 4 Israeli sockets 220-250V 10A 2P+GND

**CABINET WITH STEEL VICE**

| ORD. NO.        | DIM. mm       |
|-----------------|---------------|
| F BL 6105 01 04 | 312x726x800 h |
| F BL 6110 01 04 | 312x726x830 h |
| F BL 6115 01 04 | 312x726x850 h |



The vice can rotate by 360°.

With steel vice 120 mm

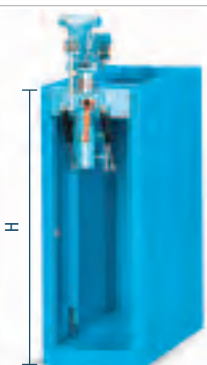

1 Open the door and...



2 ...slide it until it completely enters the vice cabinet.



3 Pull up the vice and fix it with the relative knob.



4 Adjust the vice to the required height.



## SERIES WORK STANDARD B

## EMPTY CABINET PREPARED FOR DRAWERS 27x36 EH

| ORD. NO.        | USABLE HEIGHT mm | LOAD CAP. kg | DIMENSIONS mm  |
|-----------------|------------------|--------------|----------------|
| F DD 1020 00 04 | 200              | 3100         | 564x726x283 h  |
| F DD 1030 00 04 | 300              | 3100         | 564x726x383 h  |
| F DD 1050 00 04 | 500              | 3100         | 564x726x600 h  |
| F DD 1060 00 04 | 600              | 3100         | 564x726x700 h  |
| F DD 1070 00 04 | 700              | 3100         | 564x726x800 h  |
| F DD 1072 00 04 | 725              | 3100         | 564x726x825 h  |
| F DD 1075 00 04 | 750              | 3100         | 564x726x850 h  |
| F DD 1090 00 04 | 900              | 3100         | 564x726x1000 h |



■ 01 ■ 02 ■ 04 ■ 08

## PLINTHS



| ORD. NO.        | HEIGHT mm |
|-----------------|-----------|
| F DD 9300 00 07 | 50        |
| F DD 9330 00 07 | 100       |

## EMPTY CABINET WITH DOOR WITH RIGHT-HAND OPENING

| ORD. NO.        | DOOR HEIGHT mm | USABLE HEIGHT mm | LOAD CAP. kg | DIMENSIONS mm |
|-----------------|----------------|------------------|--------------|---------------|
| F DD 1260 D0 04 | 600            | 600              | 3100         | 564x726x700 h |

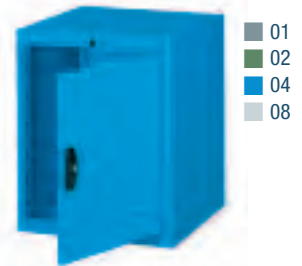

■ 01  
■ 02  
■ 04  
■ 08

## EMPTY CABINET WITH DOOR WITH LEFT-HAND OPENING

| ORD. NO.        | DOOR HEIGHT mm | USABLE HEIGHT mm | LOAD CAP. kg | DIMENSIONS mm |
|-----------------|----------------|------------------|--------------|---------------|
| F DD 1261 D0 04 | 600            | 600              | 3100         | 564x726x700 h |

■ Drawers cannot be fitted behind doors.

## EMPTY CABINET PREPARED FOR DOORS AND DRAWERS

| ORD. NO.        | DOOR HEIGHT (A) mm | DRAWERS HEIGHT (B) mm | USABLE HEIGHT (C) mm | LOAD CAP. kg | DIMENSIONS mm  |
|-----------------|--------------------|-----------------------|----------------------|--------------|----------------|
| F DD 1150 00 04 | 400                | 75                    | 500                  | 3100         | 564x726x600 h  |
| F DD 1160 00 04 | 400                | 175                   | 600                  | 3100         | 564x726x700 h  |
|                 | 425                | 150                   |                      |              |                |
|                 | 500                | 75                    |                      |              |                |
| F DD 1170 00 04 | 400                | 275                   | 700                  | 3100         | 564x726x800 h  |
|                 | 425                | 250                   |                      |              |                |
|                 | 500                | 175                   |                      |              |                |
| F DD 1172 00 04 | 575                | 100                   | 725                  | 3100         | 564x726x825 h  |
|                 | 600                | 75                    |                      |              |                |
|                 | 400                | 300                   |                      |              |                |
| F DD 1175 00 04 | 425                | 275                   | 750                  | 3100         | 564x726x850 h  |
|                 | 500                | 200                   |                      |              |                |
|                 | 575                | 125                   |                      |              |                |
| F DD 1190 00 04 | 600                | 100                   | 900                  | 3100         | 564x726x1000 h |
|                 | 400                | 325                   |                      |              |                |
|                 | 425                | 300                   |                      |              |                |
| F DD 1190 00 04 | 500                | 225                   | 900                  | 3100         | 564x726x1000 h |
|                 | 575                | 150                   |                      |              |                |
|                 | 600                | 125                   |                      |              |                |
| F DD 1190 00 04 | 400                | 475                   | 900                  | 3100         | 564x726x1000 h |
|                 | 425                | 450                   |                      |              |                |
|                 | 500                | 375                   |                      |              |                |
| F DD 1190 00 04 | 575                | 300                   | 900                  | 3100         | 564x726x1000 h |
|                 | 600                | 275                   |                      |              |                |

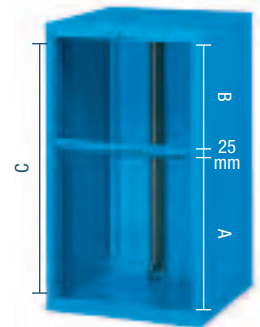

■ 01 ■ 02 ■ 04 ■ 08

■ Drawers cannot be fitted behind doors.

## REVERSIBLE DOOR

| ORD. NO.        | HEIGHT (A) mm |
|-----------------|---------------|
| F DD 9640 01 04 | 400           |
| F DD 9642 01 04 | 425           |
| F DD 9645 01 04 | 500           |
| F DD 9649 01 04 | 575           |
| F DD 9650 01 04 | 600           |



■ 01 ■ 02 ■ 04 ■ 08

■ Drawers cannot be fitted behind doors.

■ These doors can be fitted both with left-hand and right-hand opening.

## SPARE LOCKS AND SPARE HANDLE

| ORD. NO.                             |
|--------------------------------------|
| R CSR 0003 00                        |
| Spare lock (for cabinets)            |
| R CSR 0035 00                        |
| Spare lock (for handle of the doors) |
| R XDA 0002 07                        |
| Spare handle (for doors)             |

DEPTH = 726 mm (27x36 Eh)

## SERIES WORK STANDARD B

## DRAWERS

| ORD. NO.        | FRONT HEIGHT mm | LOAD CAP. kg | USABLE DIMENSIONS mm |
|-----------------|-----------------|--------------|----------------------|
| F DD 8050 00 04 | 50              | 60           | 447x600x36 h         |
| F DD 8075 00 04 | 75              | 80           | 447x600x61 h         |
| F DD 8100 00 04 | 100             | 100          | 447x600x86 h         |
| F DD 8125 00 04 | 125             | 100          | 447x600x111 h        |
| F DD 8150 00 04 | 150             | 100          | 447x600x136 h        |
| F DD 8200 00 04 | 200             | 100          | 447x600x186 h        |
| F DD 8250 00 04 | 250             | 100          | 447x600x236 h        |
| F DD 8300 00 04 | 300             | 100          | 447x600x286 h        |

Normal extension (87%)



■ Drawers cannot be fitted behind doors.

## RETRACTABLE SHELF

| ORD. NO.        | LOAD CAP. kg | USABLE DIMENSIONS mm |
|-----------------|--------------|----------------------|
| F DD 8000 00 04 | 70           | 435x610              |

Normal extension (87%)

■ 01 ■ 02 ■ 04

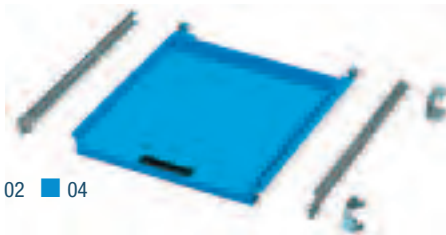

■ Set of partition material A72

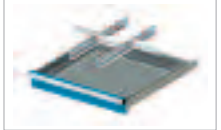

## ADJUSTABLE SHELF

| ORD. NO.        | LOAD CAP. kg | USABLE DIMENSIONS mm |
|-----------------|--------------|----------------------|
| F DD 9100 01 04 | 70           | 500x600              |

Without extension system

■ 01 ■ 02 ■ 04



27 EH (447 mm)

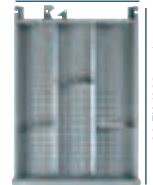

## SERIES WORK STANDARD BH

## DRAWER CABINETS SERIES F DE (BH) 27x36 EH



ORD. NO.

DRAWERS

**F DE 1010 01 04**      **1**

Cabinet with 1 normal extension drawer

Drawer load capacity: 60 kg

Dim. mm 565x725x155 h



ORD. NO.

DRAWERS

**F DE 1020 01 04**      **1**

Cabinet with 1 normal extension drawer

Drawer load capacity: 60 kg

Dim. mm 565x725x255 h



ORD. NO.

DRAWERS

**F DE 1020 02 04**      **2**

Cabinet with 2 normal extension drawers

Drawer load capacity: 60 kg

Dim. mm 565x725x255 h



ORD. NO.

DRAWERS

**F DE 1030 02 04**      **3**

Cabinet with 3 normal extension drawers

Drawer load capacity: 60 kg

Dim. mm 565x725x355 h



ORD. NO.

DRAWERS

**F DE 1045 04 04**      **4**

Cabinet with 4 normal extension drawers

Drawer load capacity: 40 kg

Dim. mm 565x725x505 h

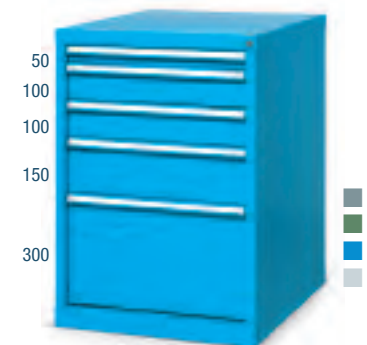

ORD. NO.

DRAWERS

**F DE 1070 01 04**      **5**

Cabinet with 5 normal extension drawers

Drawer load capacity: 60 kg

Dim. mm 565x725x800 h

## DRAWERS

| ORD. NO.               | FRONT HEIGHT mm | LOAD CAP. kg | USABLE DIMENSIONS mm |
|------------------------|-----------------|--------------|----------------------|
| <b>F DE 8050 00 04</b> | 50              | 60           | <b>447x600x36 h</b>  |
| <b>F DE 8100 00 04</b> | 100             | 60           | <b>447x600x86 h</b>  |
| <b>F DE 8150 00 04</b> | 150             | 60           | <b>447x600x136 h</b> |
| <b>F DE 8200 00 04</b> | 200             | 60           | <b>447x600x186 h</b> |
| <b>F DE 8300 00 04</b> | 300             | 60           | <b>447x600x286 h</b> |

Normal extension (87%)



## EMPTY CABINET

| ORD. NO.               | USABLE HEIGHT mm | DIMENSIONS mm        |
|------------------------|------------------|----------------------|
| <b>F DE 1010 00 04</b> | 100              | <b>565x725x155 h</b> |
| <b>F DE 1020 00 04</b> | 200              | <b>565x725x255 h</b> |
| <b>F DE 1030 00 04</b> | 300              | <b>565x725x355 h</b> |
| <b>F DE 1045 00 04</b> | 450              | <b>565x725x505 h</b> |
| <b>F DE 1070 00 04</b> | 700              | <b>565x725x800 h</b> |

■ 01 ■ 02 ■ 04 ■ 08



## FIXING MATERIAL



ORD. NO. F BL 9011 00 00

RAL 7000 F. ....01

RAL 6011 F. ....02

RAL 5012 F. ....04

RAL 7035 F. ....08

## SUPPLEMENTARY PARTS ■



■ All indicated loads are net and refer to evenly distributed weights



■ **Spare key.** Always indicate the number on the cylinder lock of the key to be replaced.

ORD. NO. R CSC 0002 00

■ **Master key.** This type of key opens all the 45 and 46 series locks.

ORD. NO. R CSC 0001 00





DEPTH = 600 mm (27 Eh)

SERIES WORK-FLEXA

MULTIPLEX WORKTOP 25 mm THICKNESS

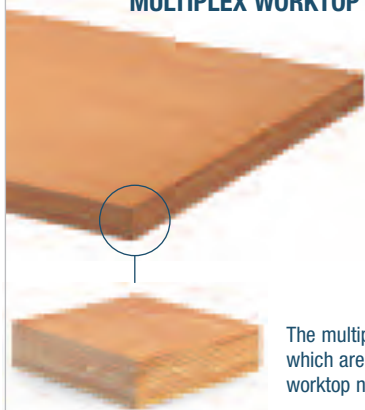

| WORKTOP DIMENSION mm | ORD. NO.        |
|----------------------|-----------------|
| 860x600              | F BI 0860 00 00 |
| 995x600              | F BI 0995 00 00 |
| 1150x600             | F BI 1150 00 00 |
| 1275x600             | F BI 1275 00 00 |
| 1340x600             | F BI 1340 00 00 |
| 1420x600             | F BI 1420 00 00 |
| 1840x600             | F BI 1840 00 00 |

The multiplex worktop includes various layers of beech wood which are planed, glued and pressed together. This makes the worktop non-deformable and load and wear resistant.

LEG

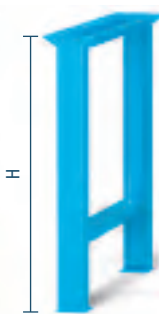

| ORD. NO.        | DIM. mm      |
|-----------------|--------------|
| F BL 6024 00 04 | 80x575x800 h |
| F BL 6039 00 04 | 80x575x850 h |



■ RAL 5012



■ RAL 5012



■ RAL 7035

■ KEY



■ The FLEXA cabinets can be fixed to the wooden shelves by means of 4 holes on the lid. Ord. no. F BL 9011 00 00 that includes screws and threaded dowels, must be used to fix the cabinet to the shelf.



■ Cabinets see page A2 - A51

RAL 7000 F. ....01

RAL 6011 F. ....02

RAL 5012 F. ....04

RAL 7035 F. ....08





## SERIES WORK-ESA

LENGTH = 2400/2775 mm (19x27 Eh-27x36 Eh)



**ORD. NO. F BF 1505 S1 04**  
RAL 5012

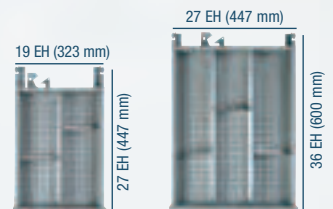

## HEXAGONAL WORKSTATION

## ORD. NO.

**F BF 1505 S1 04**

Dimensions mm 2775/2400x850 h

Tools and drawer partitioning sets excluded

## POWER TOWER

## ORD. NO.

**F BF 8145 01 04**

Including: 6 multiple socket boxes

1 thermomagnetic switch 2P 230V AC 16A I

 $\Delta N=0,03A$ 

16 Schuko sockets 220-250V 16 A 2P+GND

Dimensions mm 800/922x230 h

Attention: uncabled towers

## POWER TOWER

## ORD. NO.

**F BF 8145 02 04**

Including: 6 multiple socket boxes

1 thermomagnetic switch 2P 230V AC 16A I

 $\Delta N=0,03A$ 

11 Schuko sockets 220-250V 16 A 2P+GND

5 heavy-duty sockets 220-250V 16A 2P+GND

Dimensions mm 800/922x230 h

Attention: uncabled towers

RAL 7000 F. ....01

RAL 6011 F. ....02

RAL 5012 F. ....04

RAL 7035 F. ....08

## SUPPLEMENTARY PARTS ■



■ Sets of partitions see page A9



■ **Spare key.** Always indicate the number on the cylinder lock of the key to be replaced.

ORD. NO. R CSC 0002 00

■ **Master key.** This type of key opens all the 45 and 46 series locks.

ORD. NO. R CSC 0001 00



LENGTH = 2400/2775 mm (19x27 Eh-27x36 Eh)

SERIES WORK-ESA



- 1x50
- 2x100
- 1x150
- 1x300

| ORD. NO.        | TYPE OF WORKTOP | THICKNESS mm | LOAD CAPACITY kg |
|-----------------|-----------------|--------------|------------------|
| F BF 1505 01 04 | Multiplex       | 50           | 1000             |
| F BF 1405 01 04 | Multiplex       | 40           | 800              |

Including: 1 multiplex worktop  
 6 drawer units each with 5 normal extension 27x36 Eh drawers  
**Dimensions mm 2775/2400**

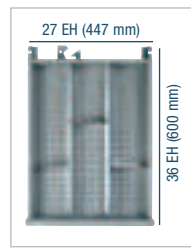

**ORD. NO.**

**F FH 8605 22 00**  
 Set of partitioning material for 27x36 Eh drawer with 50 mm front



- 1x50
- 2x100
- 1x150
- 1x300

| ORD. NO.        | TYPE OF WORKTOP | THICKNESS mm | LOAD CAPACITY kg |
|-----------------|-----------------|--------------|------------------|
| F BF 1505 03 04 | Multiplex       | 50           | 1000             |
| F BF 1405 03 04 | Multiplex       | 40           | 800              |

Including: 1 multiplex worktop  
 6 drawer units each with 5 normal extension 19x27 Eh drawers  
 6 bench wired legs with power fittings each complete with 4 Schuko sockets and thermomagnetic switch 2P 230V AC 10A  
**Dimensions mm 2775/2400**

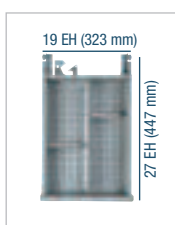

■ KEY

- RAL 7000 F. ....01
- RAL 6011 F. ....02
- RAL 5012 F. ....04
- RAL 7035 F. ....08



■ All indicated loads are net and refer to evenly distributed weights

■ Sets of partitions see page A9, A72 - A73

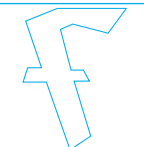

SERIES WORK-ESA

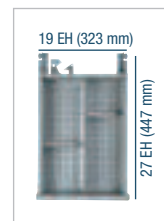

1x50  
2x100  
1x150  
1x300

| ORD. NO.               | TYPE OF WORKTOP | THICKNESS mm | LOAD CAPACITY kg |
|------------------------|-----------------|--------------|------------------|
| <b>F BF 1505 04 04</b> | Multiplex       | 50           | 1000             |
| <b>F BF 1405 04 04</b> | Multiplex       | 40           | 800              |

Including: 1 multiplex worktop

6 drawer units each with 5 normal extension 19x27 Eh drawers

6 cabinets each with 120 mm height adjustable steel vices, these rotate and can be recessed into the cabinet. The cabinet is complete with door.

**Dimensions mm 2775/2400**

Example of the hexagonal workstation with vices recessed inside the cabinet.

**ORD. NO.**  
**F FH 8205 04 00**  
Set of partitioning material for 19x27 Eh drawer with 50 mm front

**ORD. NO.**  
**F FH 8215 25 00**  
Set of partitioning material for 19x27 Eh drawer with 150 mm front

RAL 7000 F. ....01 RAL 6011 F. ....02 RAL 5012 F. ....04 RAL 7035 F. ....08

KEY ■

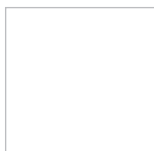
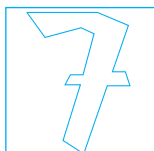

■ Sets of partitions see page A9



■ All indicated loads are net and refer to evenly distributed weights



LENGTH = 2400/2775 mm (27x27 Eh-27x36 Eh)

SERIES WORK-ESA



1x50  
2x100  
1x150  
1x300

| ORD. NO.               | TYPE OF WORKTOP | THICKNESS mm | LOAD CAPACITY kg |
|------------------------|-----------------|--------------|------------------|
| <b>F BF 1505 02 04</b> | Multiplex       | 50           | 1000             |
| <b>F BF 1405 02 04</b> | Multiplex       | 40           | 800              |

Including: 1 multiplex worktop

6 drawer units each with 5 normal extension 19x27 Eh drawers

6 bench wired legs with power fittings each complete with 4 Schuko sockets and thermomagnetic switch 2P 230V AC 10A

6 120 mm height adjustable steel vices, these rotate and can be recessed under the wooden worktop.

**Dimensions mm 2775/2400**

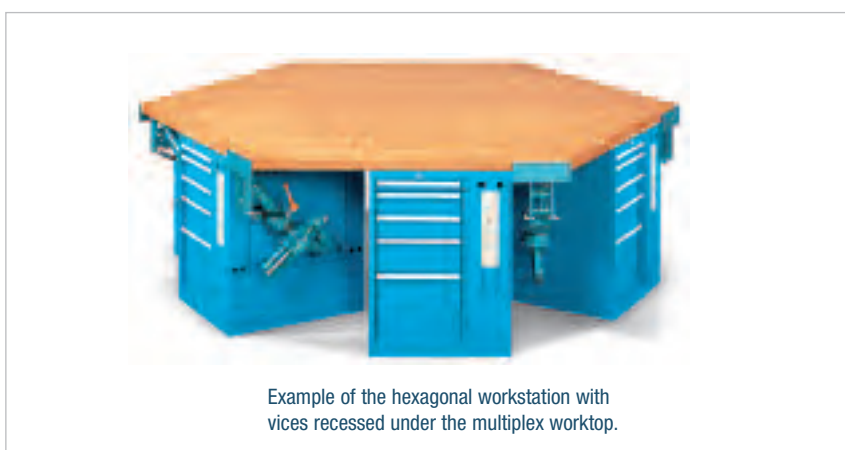

Example of the hexagonal workstation with vices recessed under the multiplex worktop.

KEY

RAL 7000 F. ....01 RAL 6011 F. ....02 RAL 5012 F. ....04 RAL 7035 F. ....08

Sets of partitions see page A9



All indicated loads are net and refer to evenly distributed weights





## SERIES WORK-SYSTEM 15-75

LENGTH = 1500 mm DEPTH = 750 mm (27x27 Eh)

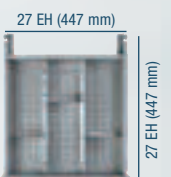

**ORD. NO. F BR 2242 S1 51**  
RAL 5012+7000

**WORKSTATION****ORD. NO.****F BR 2242 S1 51**

Dimensions mm 1500x750x865/1500 h

Complete with multi-purpose back panel and vertical drawer

Tools excluded

**COMBINATION OF STANDARD COLOURS**

- RAL 6011
- RAL 5012 +
- RAL 7000

RAL 5012  
RAL 7000 F. ....51

RAL 6011 F. ....02

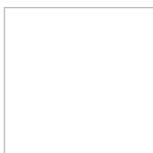
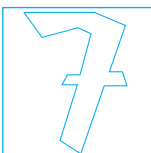
**SUPPLEMENTARY PARTS ■**

■ **Spare key.** Always indicate the number on the cylinder lock of the key to be replaced.

ORD. NO. R CSC 0002 00

■ **Master key.** This type of key opens all the 45 and 46 series locks.

ORD. NO. R CSC 0001 00



LENGTH = 1500 mm DEPTH = 750 mm (27x27 Eh)

SERIES WORK-SYSTEM 15-75

WORKTOP DIMENSIONS 1500x750x40 mm

| ORD. NO.        | TYPE OF WORKTOP | THICKNESS mm | LOAD CAPACITY kg |
|-----------------|-----------------|--------------|------------------|
| F BR 2242 01 51 | Multiplex       | 40           | 1000             |
| F BR 1202 01 51 | Steel           | 40           | 1000             |



| ORD. NO.        | TYPE OF WORKTOP | THICKNESS mm | LOAD CAPACITY kg |
|-----------------|-----------------|--------------|------------------|
| F BR 2242 03 51 | Multiplex       | 40           | 1000             |
| F BR 1202 03 51 | Steel           | 40           | 1000             |

| ORD. NO.        | TYPE OF WORKTOP | THICKNESS mm | LOAD CAPACITY kg |
|-----------------|-----------------|--------------|------------------|
| F BR 2242 05 51 | Multiplex       | 40           | 1000             |
| F BR 1202 05 51 | Steel           | 40           | 1000             |



| ORD. NO.        | TYPE OF WORKTOP | THICKNESS mm | LOAD CAPACITY kg |
|-----------------|-----------------|--------------|------------------|
| F BR 2242 08 51 | Multiplex       | 40           | 1000             |
| F BR 1202 08 51 | Steel           | 40           | 1000             |

| ORD. NO.        | TYPE OF WORKTOP | THICKNESS mm | LOAD CAPACITY kg |
|-----------------|-----------------|--------------|------------------|
| F BR 2242 S3 51 | Multiplex       | 40           | 1000             |
| -               | Steel           | 40           | 1000             |

KEY



- Worktop dimensions mm 1500x750x40 h
- Unit dimensions mm 1135x630x825 h
- All indicated loads are net and refer to evenly distributed weights

■ Set of partitions see page A19

■ RAL 5012  
■ RAL 7000 F. .... 51 ■ RAL 6011 F. .... 02



SERIES WORK-SYSTEM 20-75

LENGTH = 2000 mm DEPTH = 750 mm (27x27 Eh)

WORKTOP DIMENSIONS 2000x750x40 mm

| ORD. NO.               | TYPE OF WORKTOP | THICKNESS mm | LOAD CAPACITY kg |
|------------------------|-----------------|--------------|------------------|
| <b>F BR 2243 01 51</b> | Multiplex       | 40           | 1000             |
| <b>F BR 1203 01 51</b> | Steel           | 40           | 1000             |

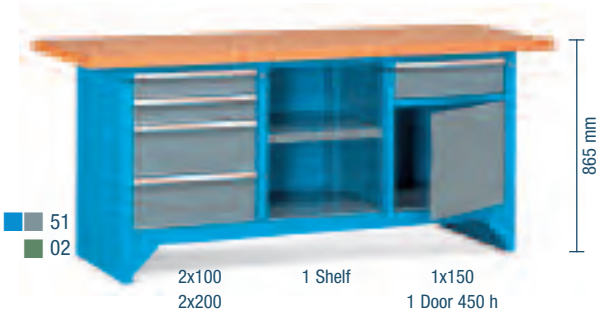
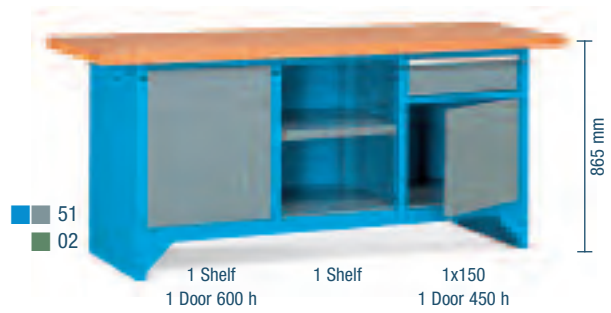

| ORD. NO.               | TYPE OF WORKTOP | THICKNESS mm | LOAD CAPACITY kg |
|------------------------|-----------------|--------------|------------------|
| <b>F BR 2243 02 51</b> | Multiplex       | 40           | 1000             |
| <b>F BR 1203 02 51</b> | Steel           | 40           | 1000             |

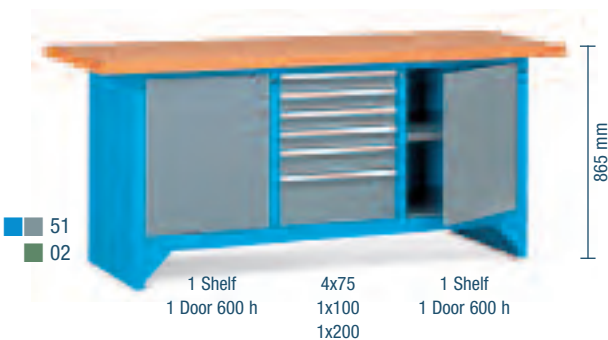

| ORD. NO.               | TYPE OF WORKTOP | THICKNESS mm | LOAD CAPACITY kg |
|------------------------|-----------------|--------------|------------------|
| <b>F BR 2243 03 51</b> | Multiplex       | 40           | 1000             |
| <b>F BR 1203 03 51</b> | Steel           | 40           | 1000             |

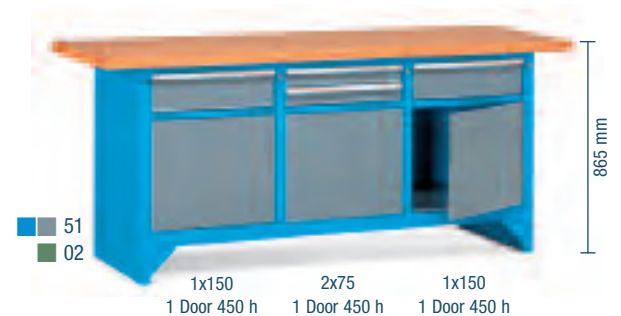

| ORD. NO.               | TYPE OF WORKTOP | THICKNESS mm | LOAD CAPACITY kg |
|------------------------|-----------------|--------------|------------------|
| <b>F BR 2243 05 51</b> | Multiplex       | 40           | 1000             |
| <b>F BR 1203 05 51</b> | Steel           | 40           | 1000             |

RAL 5012 RAL 7000 F. ....51 RAL 6011 F. ....02

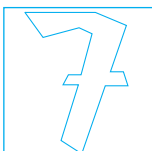

■ Set of partitions see page A19

KEY ■

- Worktop dimensions mm 2000x750x40 h
- Unit dimensions mm 1683x630x825 h
- All indicated loads are net and refer to evenly distributed weights



LENGTH = 2000 mm DEPTH = 750 mm (27x27 Eh)

SERIES WORK-SYSTEM 20-75



■ RAL 5012 +  
■ RAL 7000

**WORKSTATION**

**ORD. NO.**

**F BR 2343 S1 51**

Dimensions mm 2000x800x865/1500 h

Equipment excluded

■ INFO



[www.famispa.com](http://www.famispa.com)

■ RAL 5012  
■ RAL 7000 F. ....51 ■ RAL 6011 F. ....02





SERIES WORK-SYSTEM 25-75

LENGTH = 2500 mm DEPTH = 750 mm (27x27 Eh)

WORKTOP DIMENSIONS 2500x750x40 mm

| ORD. NO.        | TYPE OF WORKTOP | THICKNESS mm | LOAD CAPACITY kg |
|-----------------|-----------------|--------------|------------------|
| F BR 2244 01 51 | Multiplex       | 40           | 2000             |

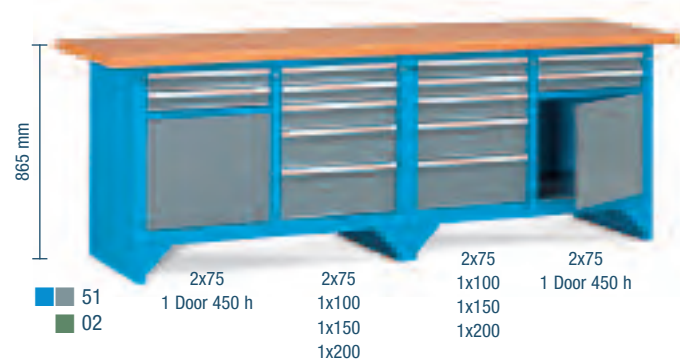

| ORD. NO.        | TYPE OF WORKTOP | THICKNESS mm | LOAD CAPACITY kg |
|-----------------|-----------------|--------------|------------------|
| F BR 2244 02 51 | Multiplex       | 40           | 2000             |

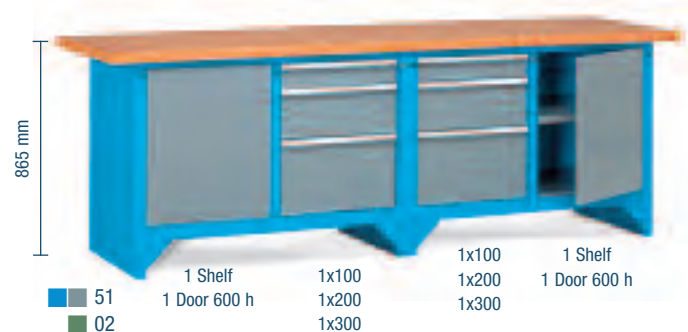

| ORD. NO.        | TYPE OF WORKTOP | THICKNESS mm | LOAD CAPACITY kg |
|-----------------|-----------------|--------------|------------------|
| F BR 2244 03 51 | Multiplex       | 40           | 2000             |

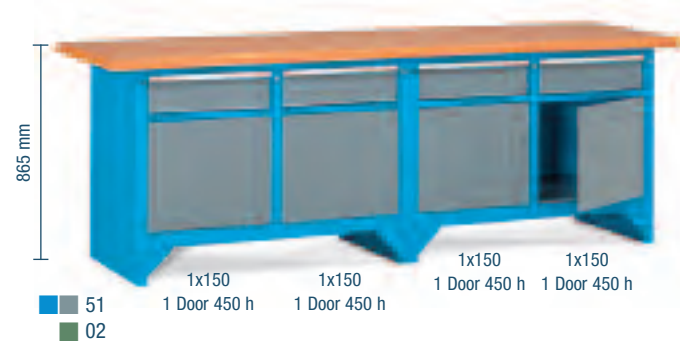

| ORD. NO.        | TYPE OF WORKTOP | THICKNESS mm | LOAD CAPACITY kg |
|-----------------|-----------------|--------------|------------------|
| F BR 2244 04 51 | Multiplex       | 40           | 2000             |

■ RAL 5012  
■ RAL 7000 F. ....51 ■ RAL 6011 F. ....02

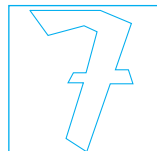

■ Set of partitions see page A19

**KEY ■**

- Worktop dimensions mm 2500x750x40 h
- Unit dimensions mm 1135x630x825 h + 1135x630x825 h
- All indicated loads are net and refer to evenly distributed weights

LENGTH = 3000 mm DEPTH = 750 mm (27x27 Eh)

SERIES WORK-SYSTEM 30-75

WORKTOP DIMENSIONS 3000x750x40 mm



| ORD. NO.        | TYPE OF WORKTOP | THICKNESS mm | LOAD CAPACITY kg |
|-----------------|-----------------|--------------|------------------|
| F BR 2245 01 51 | Multiplex       | 40           | 2000             |

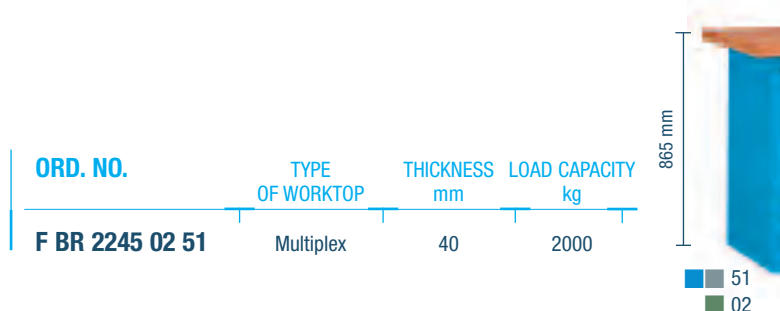

| ORD. NO.        | TYPE OF WORKTOP | THICKNESS mm | LOAD CAPACITY kg |
|-----------------|-----------------|--------------|------------------|
| F BR 2245 02 51 | Multiplex       | 40           | 2000             |



WORKSTATION

ORD. NO.

F BR 2245 S1 51

Complete with multi-purpose back panels

Dimensions mm 3000x750x865/2130 h

Tools and sets of partitioning material for drawers excluded

KEY



- Worktop dimensions mm 3000x750x40 h
- Unit dimensions mm 1135x630x825 h + 1683x630x825 h
- All indicated loads are net and refer to evenly distributed weights

■ Set of partitions see page A19

RAL 5012  
RAL 7000 F. ....51 RAL 6011 F. ....02



SERIES WORK-SYSTEM

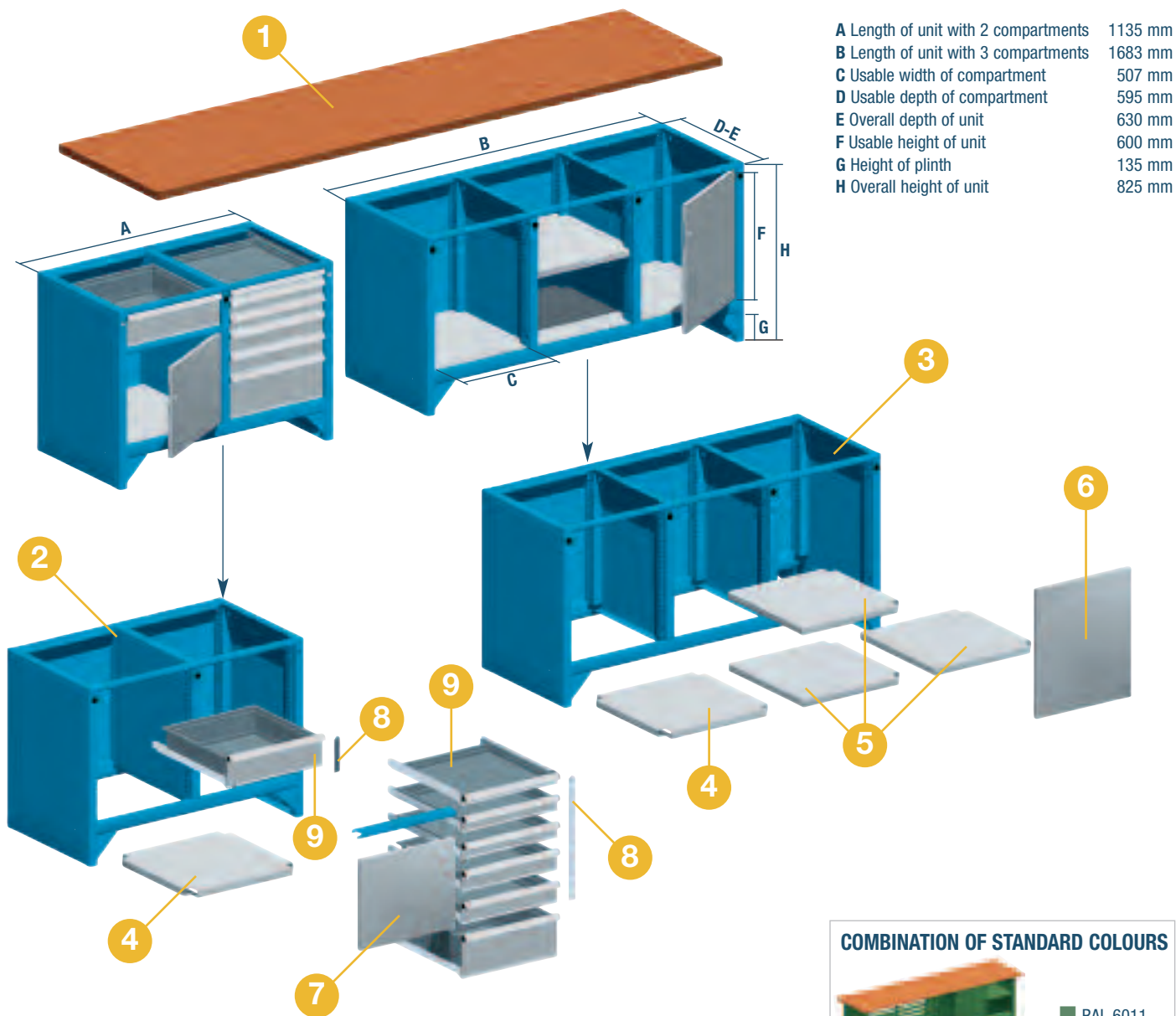

**COMBINATION OF STANDARD COLOURS**

- RAL 6011
- RAL 5012 +
- RAL 7000

**LOAD CAPACITY OF THE WORKTOP OF THE MODULAR WORKSTATIONS**  
 Workstation layout

| TYPE OF WORKTOP | THICKNESS mm | 1000 kg | 1000 kg | 2000 kg | 2000 kg |
|-----------------|--------------|---------|---------|---------|---------|
| Multiplex       | 40           | 1000 kg | 1000 kg | 2000 kg | 2000 kg |
| Steel           | 40           | 1000 kg | 1000 kg | -       | -       |

■ RAL 5012  
 ■ RAL 7000 F. ....51 ■ RAL 6011 F. ....02



**KEY ■**

■ All indicated loads are net and refer to evenly distributed weights

DEPTH = 630 mm (27x27 Eh)

## SERIES WORK-SYSTEM

**1 MULTIPLEX SHELF 750 mm DEEP 40 mm THICKNESS**

| SHELF LENGTH | ORD. NO. MULTIPLEX SHELF | ORD. NO. PRE-DRILLINGS                           | FOR:   |
|--------------|--------------------------|--|--|
| 1500         | F BI A242 00 00          | 1 pc F BR 0960 00 00                             | 1 unit with 2 compartments                                   |
| 2000         | F BI A270 00 00          | 1 pc F BR 0961 00 00                             | 1 unit with 3 compartments                                   |
| 2500         | F BI A284 00 00          | 2 pcs F BR 0960 00 00                            | 2 units with 2 compartments                                  |
| 3000         | F BI A298 00 00          | + 1 pc F BR 0960 00 00<br>+ 1 pc F BR 0961 00 00 | + 1 unit with 2 compartments<br>+ 1 unit with 3 compartments |

■ For other wooden worktops see page C2 - C3

**1 STEEL SHELF 750 mm DEEP 40 mm THICKNESS**

| SHELF LENGTH | ORD. NO. MULTIPLEX SHELF   | ORD. NO. MULTIPLEX SHELF   | ORD. NO. PRE-DRILLINGS | FOR:                       |
|--------------|----------------------------|----------------------------|------------------------|----------------------------|
| 1500         | ■ RAL 7000 F BR 0020 00 01 | ■ RAL 6011 F BR 0020 00 02 | 1 pc F BR 0950 00 00   | 1 unit with 2 compartments |
| 2000         | ■ RAL 7000 F BR 0030 00 01 | ■ RAL 6011 F BR 0030 00 02 | 1 pc F BR 0951 00 00   | 1 unit with 3 compartments |

**2 UNIT WITH 2 COMPARTMENTS DIM. mm 1135x630x825 h**

| ORD. NO.                   |
|----------------------------|
| ■ RAL 5012 F BR 2242 00 04 |
| ■ RAL 6011 F BR 2242 00 02 |

**3 UNIT WITH 3 COMPARTMENTS DIM. mm 1683x630x825 h**

| ORD. NO.                   |
|----------------------------|
| ■ RAL 5012 F BR 2243 00 04 |
| ■ RAL 6011 F BR 2243 00 02 |

**4 LEFT-HAND STEEL SHELVES**  
DIMENSIONS mm 579x566x35 h

| ORD. NO.                   |
|----------------------------|
| ■ RAL 7000 F BR 0220 01 01 |
| ■ RAL 6011 F BR 0220 01 02 |

This shelf is used as a bottom or an adjustable shelf for the **left-hand compartments of each unit**

Shelf load capacity: 50 kg

**5 CENTRAL OR RIGHT-HAND STEEL SHELVES**  
DIMENSIONS mm 543x566x35 h

| ORD. NO.                   |
|----------------------------|
| ■ RAL 7000 F BR 0230 01 01 |
| ■ RAL 6011 F BR 0230 01 02 |

This shelf is used as a bottom or an adjustable shelf for the **central or the right-hand compartments of each unit**

Shelf load capacity: 50 kg

**6 DOORS DIMENSIONS mm 504x598 h**

| ORD. NO. right door        | ORD. NO. left door         |
|----------------------------|----------------------------|
| ■ RAL 7000 F BR 0720 00 01 | ■ RAL 7000 F BR 0721 00 01 |
| ■ RAL 6011 F BR 0720 00 02 | ■ RAL 6011 F BR 0721 00 02 |

This door is available with right and left-hand openings. It is **600 mm** high and completely covers a compartment. Supplied standard with cylinder lock and two keys.

**7 DOORS DIMENSIONS mm 504x420 h**

| ORD. NO. right door        | ORD. NO. left door         |
|----------------------------|----------------------------|
| ■ RAL 7000 F BR 0710 00 51 | ■ RAL 7000 F BR 0711 00 51 |
| ■ RAL 6011 F BR 0710 00 02 | ■ RAL 6011 F BR 0711 00 02 |

This door is available with right and left-hand openings. It partially covers a compartment up to a height of 450 mm. A shelf or drawers must be fitted over the door.

Supplied standard with cylinder lock and two keys.

**8 150 – 600 mm HIGH LOCKING BARS FOR DRAWERS**

| ORD. NO. length 150 mm | ORD. NO. length 600 mm |
|------------------------|------------------------|
| F BR 0410 00 00        | F BR 0430 00 00        |

These locking systems include a 150 mm or 600 mm locking bar and a cylinder lock with two keys.

**9 DRAWERS**

| ORD. NO.        | FRONT HEIGHT mm | LOAD CAPACITY kg | USABLE DIMENSIONS mm |
|-----------------|-----------------|------------------|----------------------|
| F DB 8050 00 04 | 50              | 50               | 447x447x36 h         |
| F DB 8075 00 04 | 75              | 70               | 447x447x61 h         |
| F DB 8100 00 04 | 100             | 70               | 447x447x86 h         |
| F DB 8125 00 04 | 125             | 70               | 447x447x111 h        |
| F DB 8150 00 04 | 150             | 70               | 447x447x136 h        |
| F DB 8200 00 04 | 200             | 70               | 447x447x186 h        |
| F DB 8250 00 04 | 250             | 70               | 447x447x236 h        |
| F DB 8300 00 04 | 300             | 70               | 447x447x286 h        |

Extension 100%



■ 01  
■ 02  
■ 04  
■ 08



## SERIES WORK-LOOK 10



ORD. NO. F BH A328 S3 04  
RAL 5012

## WORKSTATION

## ORD. NO.

F BH A328 S3 04

Dimensions mm 1300x800x840/2110 h

Tools, boxes and electrical equipment excluded

RAL 7000 F. ....01

RAL 6011 F. ....02

RAL 5012 F. ....04

RAL 7035 F. ....08

## INFO ■



■ Set of hooks  
see page C66

[www.famispa.com](http://www.famispa.com)



LENGTH = 1000 mm

SERIES WORK-LOOK 10

ORD. NO. BACK PANEL FOR

**F BL A010 03 04** Wood

- 2 support columns 632 mm h
  - 2 perforated back panels 972x304 mm h
- Tools, hooks and boxes excluded

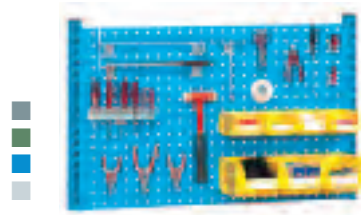

ORD. NO. BACK PANEL FOR

**F BL A110 05 04** Wood

- 2 support columns 632 mm h, 1 shelf 955x220 mm
  - 1 perforated back panel 972x304 mm h
  - 1 multiple socket box with cabling complete with 5 Schuko sockets and thermomagnetic switch 2P 230V AC 10A I Δ N=0,01A
  - 1 swivel arm with two joints complete with practibox
- Tools, hooks and boxes excluded

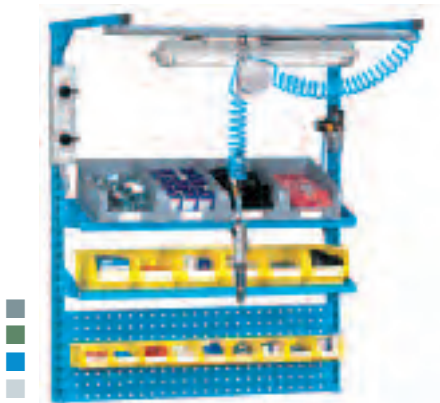

ORD. NO. BACK PANEL FOR

**F BL A010 04 04** Wood

- 2 support columns 936 mm
  - 3 perforated back panels 972x304 mm
- Tools, hooks and boxes excluded

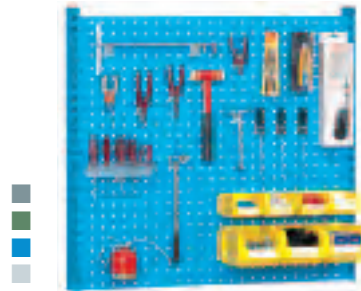

ORD. NO. BACK PANEL FOR

**F BL A110 09 04** Wood

- 2 support columns 1240 mm h, 1 shelf 955x220 mm
  - 1 shelf 955x320 mm, 1 perforated back panel 972x304 mm h
  - 1 pair of carrier arms with aluminium slide track
  - 1 additional aluminium slide track, 1 2x18W Philips lamp
  - 1 pneumatic system
  - 1 multiple socket box with cabling complete with 5 Schuko sockets and thermomagnetic switch 2P 230V AC 10A I Δ N=0,01A
- Tools and boxes excluded



ORD. NO. BACK PANEL FOR

**F BL A110 10 04** Wood

- 2 support columns 1240 mm h, 1 plain back panel 972x304 mm h
  - 2 shelves 955x420 mm
  - 1 pair of carrier arms with aluminium slide track
  - 1 2x36W Waldmann lamp
  - 1 multiple socket box with cabling complete with 5 Schuko sockets and thermomagnetic switch 2P 230V AC 10A I Δ N=0,01A
  - 1 monitor arm load capacity 13 kg
- Tools excluded

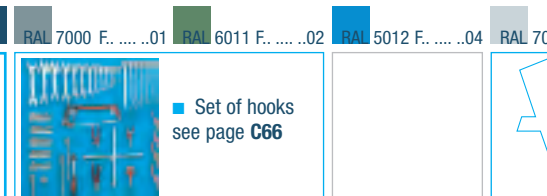

■ INFO

RAL 7000 F. ....01 RAL 6011 F. ....02 RAL 5012 F. ....04 RAL 7035 F. ....08



[www.famispa.com](http://www.famispa.com)

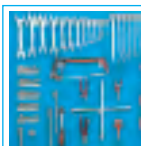

■ Set of hooks  
see page C66

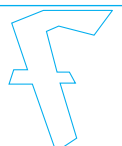



ORD. NO. F BH A342 S2 04  
RAL 5012

## WORKSTATION

### ORD. NO.

**F BH A342 S2 04**

Dim. mm 1500x800x840/2110 h

Tools and drawer partitioning set  
excluded

RAL 7000 F. ....01

RAL 6011 F. ....02

RAL 5012 F. ....04

RAL 7035 F. ....08

## INFO ■



■ Set of hooks  
see page C66

[www.famispa.com](http://www.famispa.com)



LENGTH = 1500 mm

SERIES WORK-LOOK 15

ORD. NO. BACK PANEL FOR

**F BL A015 01 07** Wood  
 2 height-adjustable shelves brackets 215-335 mm h  
 1 shelf of multiplex 1500x300x20 mm h  
 Tools and boxes excluded

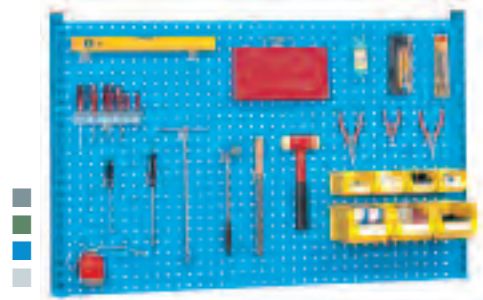
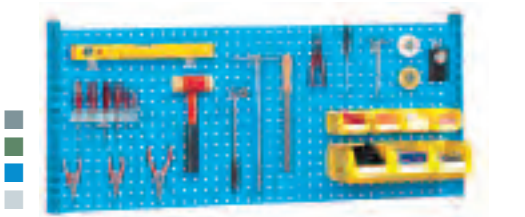

ORD. NO. BACK PANEL FOR

**F BL A015 06 04** Wood  
**F BL B015 06 04** Steel  
 2 support columns 632 mm h  
 2 perforated back panels 1457x304 mm h  
 Tools, hooks and boxes excluded

ORD. NO. BACK PANEL FOR

**F BL A015 07 04** Wood  
 2 support columns 936 mm h  
 3 perforated back panels 1457x304 mm h  
 Tools, hooks and boxes excluded

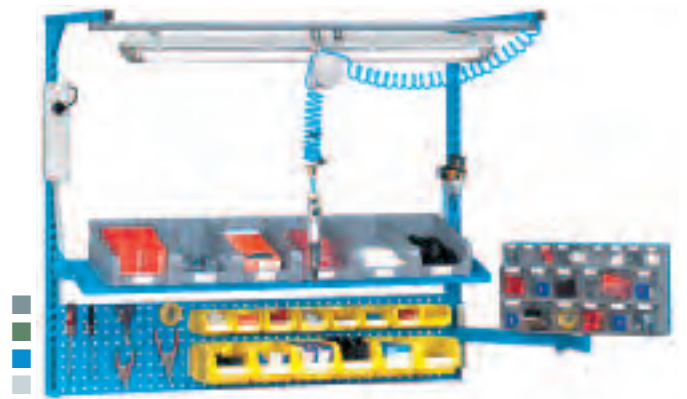
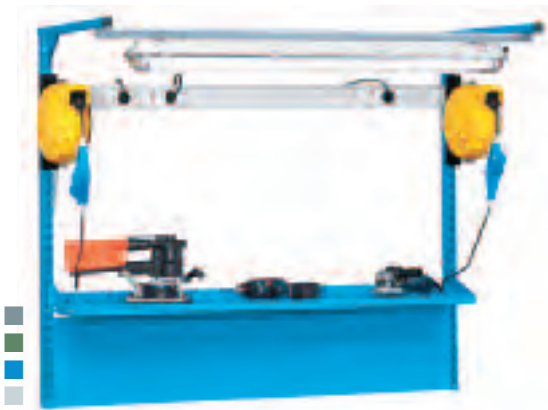

ORD. NO. BACK PANEL FOR

**F BL A115 09 04** Wood  
 2 support columns 1240 mm h, 1 shelf 1440x320 mm  
 1 plain back panel 1457x304 mm h  
 1 pair of carrier arms with aluminium slide track  
 1 power panelling with cabling complete with 9 Schuko sockets and thermomagnetic switch 2P 230V AC 10A | Δ N=0,01A  
 1 pair of supports for rear power panelling  
 2 230V winders with 10 metres of cable 3x1,5 mm<sup>2</sup>  
 1 heavy duty flying socket 220-250 V 16A 2P+GND and  
 1 Schuko socket 220-250V 16A 2P+GND  
 1 2x36W Philips lamp  
 Tools excluded

ORD. NO. BACK PANEL FOR

**F BL A115 14 04** Wood  
 2 support columns 1240 mm h  
 1 shelf 1440x320 mm  
 1 perforated back panel 1457x304 mm h  
 1 pair of carrier arms with aluminium slide track  
 1 additional aluminium slide track  
 1 2x36W Philips lamp  
 1 pneumatic system  
 1 multiple socket box with cabling complete with 5 Schuko sockets and thermomagnetic switch 2P 230V AC 10A | Δ N=0,01A  
 1 swivel arm with two joints complete with practibox  
 Tools, hooks and boxes excluded

INFO

RAL 7000 F. ....01 RAL 6011 F. ....02 RAL 5012 F. ....04 RAL 7035 F. ....08



www.famispa.com

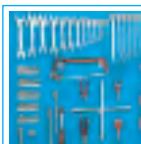

■ Set of hooks  
 see page C66

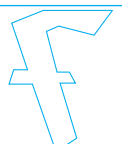



## SERIES WORK-LOOK 20

LENGTH = 2000 mm



RAL 7000 F. ....01

RAL 6011 F. ....02

RAL 5012 F. ....04

RAL 7035 F. ....08

INFO ■

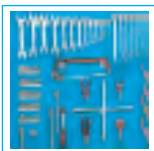
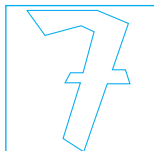

■ Set of hooks  
see page C66

[www.famispa.com](http://www.famispa.com)



LENGTH = 2000 mm

SERIES WORK-LOOK 20

ORD. NO. BACK PANEL FOR

**F BL A020 01 07** Wood  
 2 height-adjustable shelves brackets 215-335 mm h  
 1 shelf in multiplex 2000x300x20 mm h  
 Tools and boxes excluded



ORD. NO. BACK PANEL FOR

**F BL A020 05 04** Wood  
**F BL B020 05 04** Steel  
 3 support columns 632 mm h, 2 shelves 955x320 mm  
 2 perforated back panels 972x304 mm h  
 Tools, hooks and boxes excluded

ORD. NO. BACK PANEL FOR

**F BL A020 07 04** Wood  
**F BL B020 07 04** Steel  
 3 support columns 632 mm h  
 4 perforated back panels 972x304 mm h  
 Tools and hooks excluded

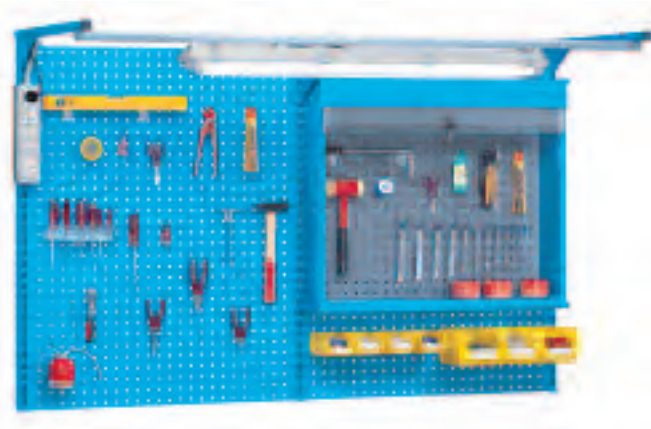

ORD. NO. BACK PANEL FOR

**F BL A120 20 04** Wood  
 3 support columns 1240 mm h  
 5 perforated back panels 972x304 mm h  
 1 carrier arm assembly with aluminium slide track  
 1 roller shutter cabinet  
 1 multiple socket box with cabling complete with 5 Schuko sockets and thermomagnetic switch 2P 230V AC 10A I Δ N=0,01A  
 1 2x36W Philips lamp  
 Tools, hooks and boxes excluded

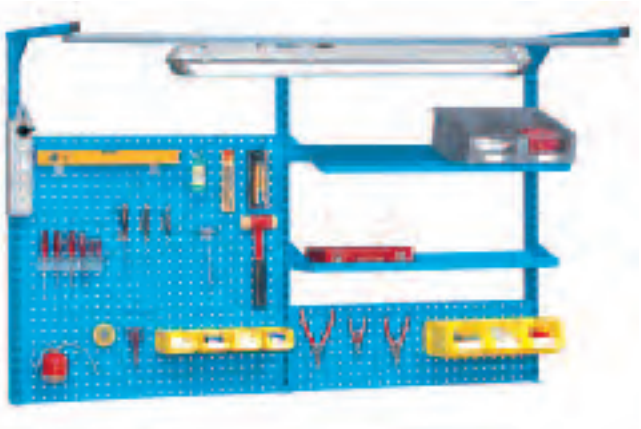

ORD. NO. BACK PANEL FOR

**F BL A120 13 04** Wood  
 3 support columns 1240 mm h  
 1 shelf 955x220 mm, 1 shelf 955x320 mm  
 4 perforated back panels 972x304 mm h  
 1 carrier arm assembly with aluminium slide track  
 1 2x36W Philips lamp  
 1 multiple socket box with cabling complete with 5 Schuko sockets and thermomagnetic switch 2P 230V AC 10A I Δ N=0,01A  
 Tools, hooks and boxes excluded

■ INFO



www.famispa.com

RAL 7000 F. ....01 RAL 6011 F. ....02 RAL 5012 F. ....04 RAL 7035 F. ....08

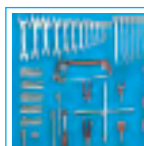

■ Set of hooks see page C66

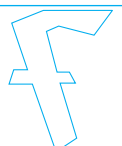

## SERIES WORK-LOOK 25



ORD. NO. F BK A584 S1 04  
RAL 5012

## WORKSTATION

## ORD. NO.

F BK A584 S1 04

Dimensions mm 2500x800x850/2120 h

Tools excluded

RAL 7000 F. ....01

RAL 6011 F. ....02

RAL 5012 F. ....04

RAL 7035 F. ....08

## INFO ■

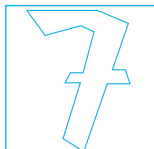

■ Set of hooks  
see page C66

[www.famispa.com](http://www.famispa.com)





LENGTH = 2500

SERIES WORK-LOOK 25

ORD. NO.

BACK PANEL FOR

**F BL A025 02 07**

Wood

3 height-adjustable shelves brackets 215-335 mm h

1 shelf in multiplex 2500x300x20 mm h

Tools and boxes excluded



ORD. NO.

BACK PANEL FOR

**F BL A025 06 04**

Wood

3 support columns 632 mm h

1 shelf 1440x220 mm

1 shelf 955x220 mm

1 perforated back panel 972x304 mm h

1 perforated back panel 1457x304 mm h

Tools, hooks and boxes excluded

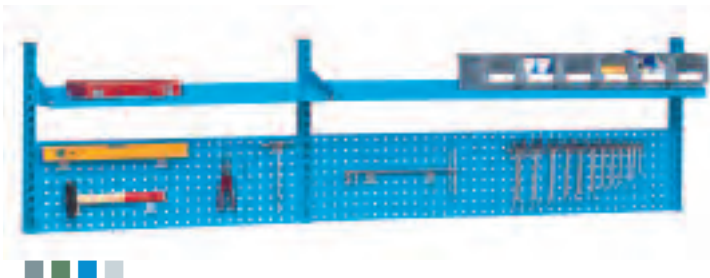

ORD. NO.

BACK PANEL FOR

**F BL A025 08 04**

Wood

3 support columns 936 mm h

3 perforated back panels 972x304 mm h

3 perforated back panels 1457x304 mm h

Tools, hooks and boxes excluded

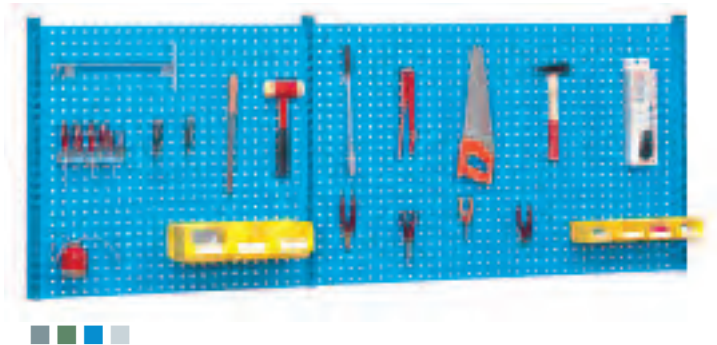

ORD. NO.

BACK PANEL FOR

ORD. NO.

**F BL A125 11 04**

Wood

3 support columns 1240 mm h

1 shelf 1440x320 mm

1 shelf 955x320 mm

1 shelf 1440x220 mm

2 perforated back panels 972x304 mm h

1 perforated back panel 1457x304 mm h

1 carrier arm assembly with aluminium slide track

1 2x36W Philips lamp

1 multiple socket box with cabling complete with 5 Schuko sockets and thermomagnetic switch 2P 230V AC 10A I Δ N=0,01A

Tools, hooks and boxes excluded

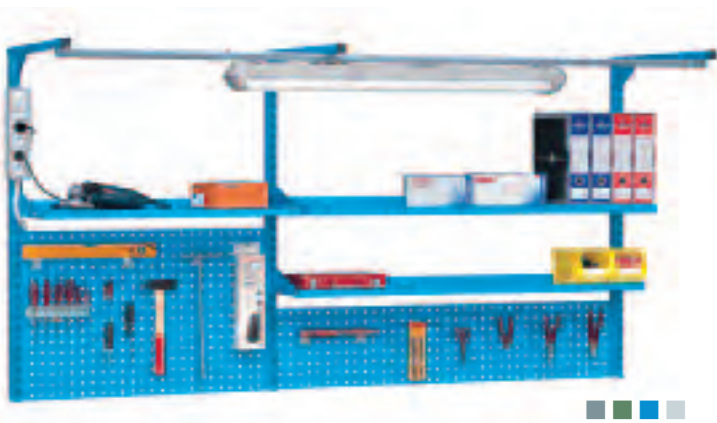

■ INFO

RAL 7000 F. ....01 RAL 6011 F. ....02 RAL 5012 F. ....04 RAL 7035 F. ....08



www.famispa.com

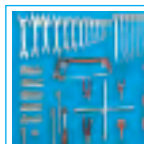

■ Set of hooks  
see page C66

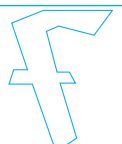



## SERIES WORK-LOOK 30



**ORD. NO. F BI A598 S2 04**  
RAL 5012

**WORKSTATION****ORD. NO.****F BI A598 S2 04**

Dimensions mm 3000x800x850/2120 h

Tools excluded

RAL 7000 F. ....01

RAL 6011 F. ....02

RAL 5012 F. ....04

RAL 7035 F. ....08

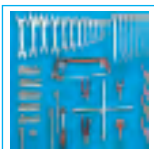
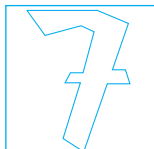
**INFO ■**

■ Set of hooks  
see page C66

[www.famispa.com](http://www.famispa.com)



LENGTH = 3000 mm

SERIES WORK-LOOK 30

ORD. NO. BACK PANEL FOR

**F BL A030 02 07** Wood  
 3 height-adjustable shelves brackets 215-335 mm h  
 1 shelf of multiplex 3000x300x20 mm h

Tools and boxes excluded



ORD. NO. BACK PANEL FOR

**F BL A030 03 04** Wood  
 3 support columns 632 mm h  
 2 shelves 1440x220 mm  
 2 shelves 1440x320 mm

Tools, hooks and boxes excluded

ORD. NO. BACK PANEL FOR

**F BL A030 07 04** Wood  
 3 support columns 632 mm h  
 4 perforated back panels 1457x304 mm h

Tools, hooks and boxes excluded



ORD. NO. BACK PANEL FOR

**F BL A130 11 04** Wood  
 3 support columns 1240 mm h  
 3 perforated back panels 1457x304 mm h  
 2 shelves 1440x320 mm h  
 1 carrier arm assembly with aluminium slide track  
 1 2x36W Philips lamp  
 1 pair of supports for rear power panelling  
 1 power panelling with cabling complete with 9 Schuko sockets and thermomagnetic switch 2P 230V AC 10A I Δ N=0,001A

Tools, hooks and boxes excluded

■ INFO

RAL 7000 F. ....01 RAL 6011 F. ....02 RAL 5012 F. ....04 RAL 7035 F. ....08



www.famispa.com

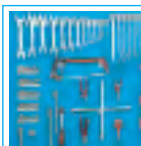

■ Set of hooks  
 see page C66



SERIES WORK-LOOK

SET OF SUPPORT COLUMNS WITH BOTH SIDE DUAL SLOTS  
FOR STEEL WORKTOPS LENGTH 1500 MM

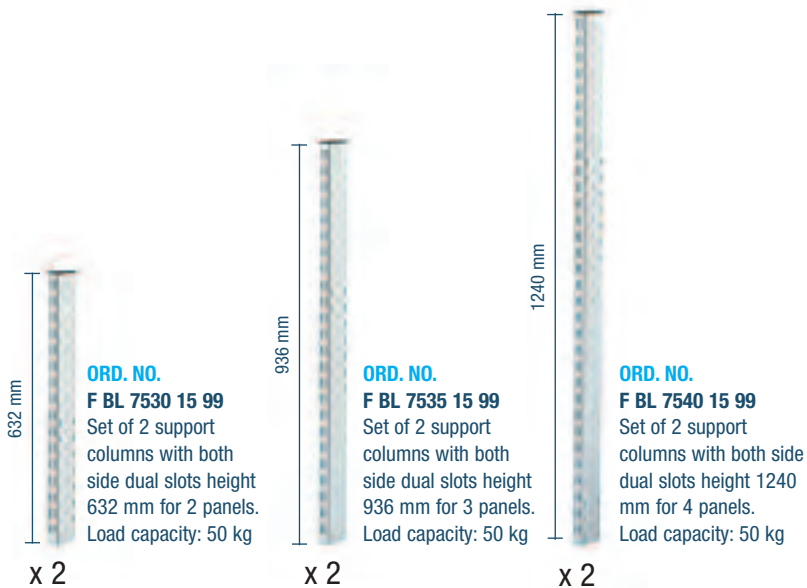

**ORD. NO.**  
**F BL 7530 15 99**  
Set of 2 support columns with both side dual slots height 632 mm for 2 panels.  
Load capacity: 50 kg

**ORD. NO.**  
**F BL 7535 15 99**  
Set of 2 support columns with both side dual slots height 936 mm for 3 panels.  
Load capacity: 50 kg

**ORD. NO.**  
**F BL 7540 15 99**  
Set of 2 support columns with both side dual slots height 1240 mm for 4 panels.  
Load capacity: 50 kg

■ 01 ■ 02 ■ 04 ■ 08 ■ 99

SUPPORT COLUMNS WITH BOTH SIDE DUAL SLOTS FOR WOODEN WORKTOPS

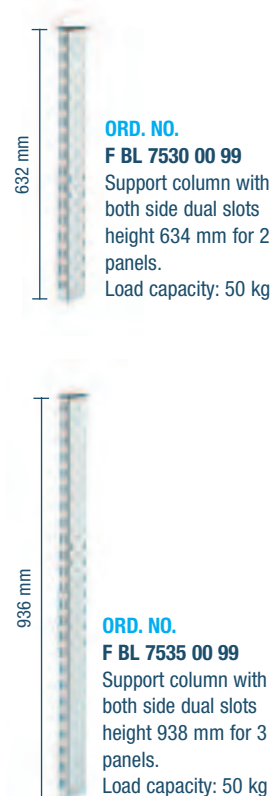

**ORD. NO.**  
**F BL 7530 00 99**  
Support column with both side dual slots height 634 mm for 2 panels.  
Load capacity: 50 kg

**ORD. NO.**  
**F BL 7535 00 99**  
Support column with both side dual slots height 938 mm for 3 panels.  
Load capacity: 50 kg

SET OF SUPPORT COLUMNS WITH BOTH SIDE DUAL SLOTS  
FOR STEEL WORKTOPS LENGTH 2000 MM

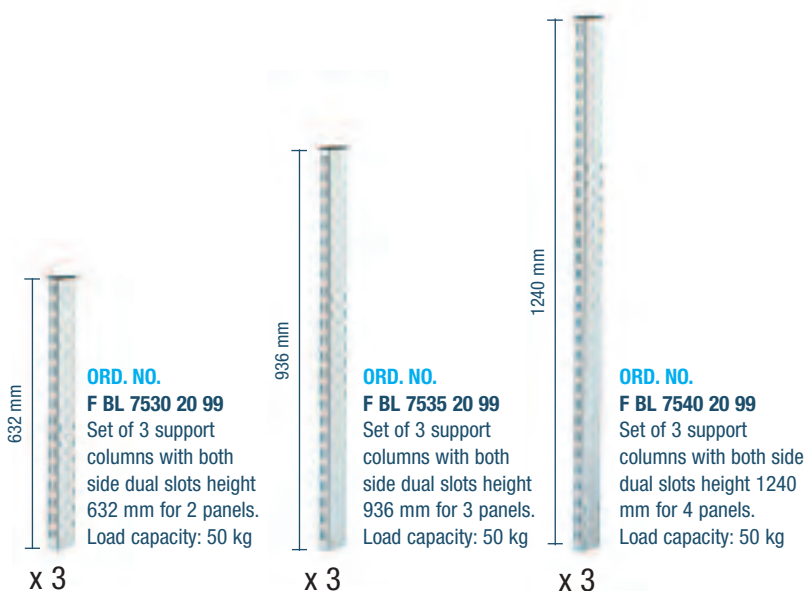

**ORD. NO.**  
**F BL 7530 20 99**  
Set of 3 support columns with both side dual slots height 632 mm for 2 panels.  
Load capacity: 50 kg

**ORD. NO.**  
**F BL 7535 20 99**  
Set of 3 support columns with both side dual slots height 936 mm for 3 panels.  
Load capacity: 50 kg

**ORD. NO.**  
**F BL 7540 20 99**  
Set of 3 support columns with both side dual slots height 1240 mm for 4 panels.  
Load capacity: 50 kg

■ 01 ■ 02 ■ 04 ■ 08 ■ 99

■ 01 ■ 02 ■ 04 ■ 08 ■ 99

RAL 7000 F. ....01 RAL 6011 F. ....02 RAL 5012 F. ....04 RAL 7035 F. ....08

KEY ■



■ All indicated loads are net and refer to evenly distributed weights

**SHELF FOR MULTI-PURPOSE PANELS LENGTH 1000 mm**



Height-adjustable tilting shelf in 2 positions with front or rear upstand

available in 3 dimensions:

955x220 mm 955x320 mm 955x420 mm

| ORD. NO.        | DEPTH OF SHELF mm | LOAD CAPACITY kg |
|-----------------|-------------------|------------------|
| F BL 7750 00 04 | 220               | 25               |
| F BL 7755 00 04 | 320               | 25               |
| F BL 7760 00 04 | 420               | 25               |
| F BL 7762 00 04 | 600               | 25               |

■ 01 ■ 02 ■ 04 ■ 08 ■ 99

**SHELF FOR MULTI-PURPOSE PANELS LENGTH 1500 mm**



Height-adjustable tilting shelf in 2 positions with front or rear upstand

available in 3 dimensions:

1440x220 mm 1440x320 mm 1440x420 mm

| ORD. NO.        | DEPTH OF SHELF mm | LOAD CAPACITY kg |
|-----------------|-------------------|------------------|
| F BL 7795 00 04 | 220               | 25               |
| F BL 7800 00 04 | 320               | 25               |
| F BL 7805 00 04 | 420               | 25               |

■ 01 ■ 02 ■ 04 ■ 08 ■ 99

**PERFORATED PANEL**



Perforated panel equipped for fixing the support columns with both side dual slots, available in two sizes:

973x304 mm h for length 1000 mm  
1458x304 mm h for length 1500 mm

| ORD. NO.        | LENGTH OF PANEL mm | LOAD CAPACITY kg |
|-----------------|--------------------|------------------|
| F BL 7620 00 04 | 973                | 25               |
| F BL 7635 00 04 | 1458               | 25               |

■ 01 ■ 02 ■ 04 ■ 08

**PLAIN PANEL**



Plain panel equipped for fixing the support columns with both side dual slots, available in two sizes:

973x304 mm h for length 1000 mm  
1458x304 mm h for length 1500 mm

| ORD. NO.        | LENGTH OF PANEL mm |
|-----------------|--------------------|
| F BL 7670 00 04 | 973                |
| F BL 7685 00 04 | 1458               |

■ 01 ■ 02 ■ 04 ■ 08

■ KEY

RAL 7000 F. ....01 RAL 6011 F. ....02 RAL 5012 F. ....04 RAL 7035 F. ....08



■ All indicated loads are net and refer to evenly distributed weights

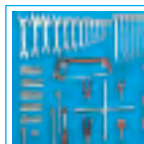

■ Set of hooks  
see page C66

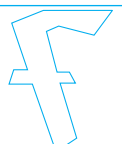



## SERIES WORK-LOOK

## PAIR OF CARRIER ARMS WITH ALUMINIUM SLIDE TRACK LENGTH 1000/1500 mm

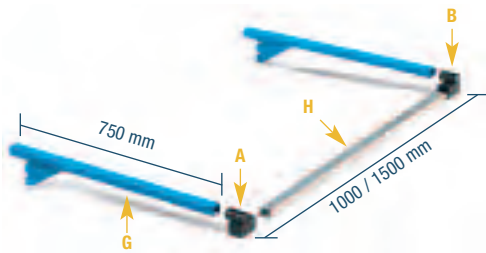

Pair of carrier arms with slide track depth **750 mm** for length **1000-1500 mm**. Includes 2 carrier arms (ref. G), 1 pair of plastic end connectors (ref. A+B) and 1 aluminium track (ref. H).

| ORD. NO.               | LENGTH OF SLIDE TRACK mm | LOAD CAPACITY kg |
|------------------------|--------------------------|------------------|
| <b>F BL 9810 01 54</b> | 1000                     | 10               |
| <b>F BL 9815 01 54</b> | 1500                     | 10               |

■ RAL 7000 + Aluminium F. ....52    ■ RAL 5012 + Aluminium F. ....54  
■ RAL 6011 + Aluminium F. ....53    ■ RAL 7035 + Aluminium F. ....55

## CARRIER ARMS ASSEMBLY WITH ALUMINIUM SLIDE TRACK LENGTH 2000/2500/3000 mm

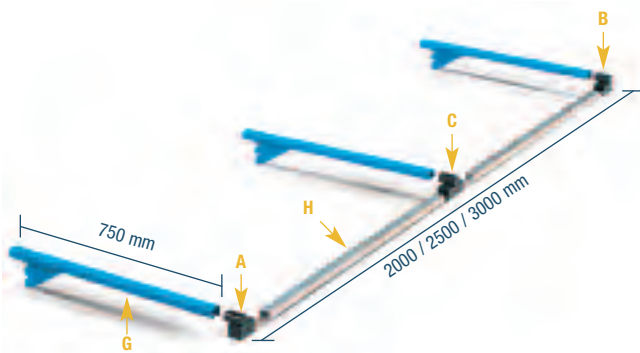

Carrier arms assembly with slide track depth **750 mm** for length **2000-2500-3000 mm**. Includes 3 carrier arms (ref. G), 1 pair of plastic end connectors (ref. A+B), 1 plastic junction connector (ref. C) and 2 aluminium tracks (ref. H).

| ORD. NO.               | LENGTH OF SLIDE TRACK mm | LOAD CAPACITY kg |
|------------------------|--------------------------|------------------|
| <b>F BL 9820 01 54</b> | 2000                     | 10               |
| <b>F BL 9825 01 54</b> | 2500                     | 10               |
| <b>F BL 9830 01 54</b> | 3000                     | 10               |

■ RAL 7000 + Aluminium F. ....52    ■ RAL 5012 + Aluminium F. ....54  
■ RAL 6011 + Aluminium F. ....53    ■ RAL 7035 + Aluminium F. ....55



■ RAL 7035

## WORKSTATION

## ORD. NO.

**F BH A370 S2 08**

Dimensions mm 2000x800x840/2110 h

Tools and boxes excluded

## CARRIER ARMS ASSEMBLY WITH ALUMINIUM SLIDE TRACK LENGTH 3000 mm

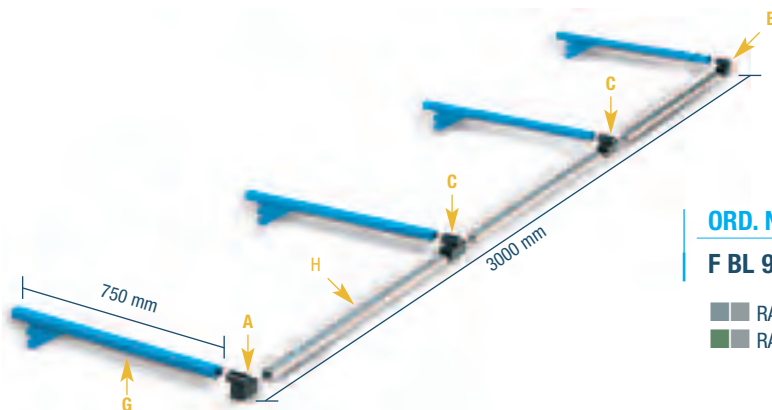

Carrier arms assembly with slide track depth **750 mm** for length **3000 mm**. Includes 4 carrier arms (ref. G), 1 pair of plastic end connectors (ref. A+B), 2 plastic junction connectors (ref. C) and 3 aluminium tracks (ref. H).

| ORD. NO.               | LENGTH OF SLIDE TRACK mm | LOAD CAPACITY kg |
|------------------------|--------------------------|------------------|
| <b>F BL 9830 02 54</b> | 3000                     | 10               |

■ RAL 7000 + Aluminium F. ....52    ■ RAL 5012 + Aluminium F. ....54  
■ RAL 6011 + Aluminium F. ....53    ■ RAL 7035 + Aluminium F. ....55

### ADDITIONAL ALUMINIUM SLIDE TRACK WITH CONNECTORS

Additional aluminium slide track with connectors.  
The slide tracks with length 2000-2500- 3000 are supplied in various sections.



| ORD. NO.        | LENGTH OF SLIDE TRACK mm |
|-----------------|--------------------------|
| F BL 9810 10 00 | 1020                     |
| F BL 9815 10 00 | 1500                     |
| F BL 9820 10 00 | 2000                     |
| F BL 9825 10 00 | 2500                     |
| F BL 9830 10 00 | 3000*                    |
| F BL 9830 11 00 | 3000**                   |

\*additional alumin. slide track for assembly with 3 supports  
\*\*additional alumin. slide track for assembly with 4 supports

### CONNECTORS

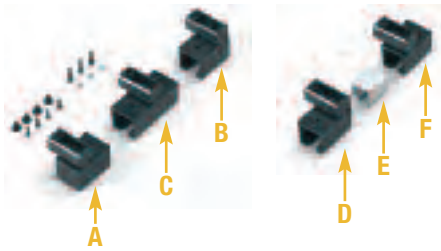

| ORD. NO.        | REFERENCE |
|-----------------|-----------|
| F BL 9841 00 07 | A+B       |
| F BL 9840 00 07 | C         |
| F BL 9842 00 07 | D+E+F     |

The set of connectors (ref. D+E+F) is used when the tracks of several workstations have to be joined together for the transit of the trolley. The slide track (ref. E) is 60 mm in length.

### ROLLER SHUTTER CABINET

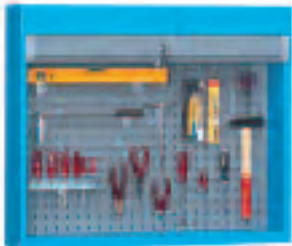

| ORD. NO.                                   | FIXING TYPE            | CYLINDER LOCK | LOAD CAPACITY kg |
|--|------------------------|---------------|------------------|
| F BL 7011 01 51                            | to the wall            | series 45     | 50               |
| F BL 7011 02 51                            | to the support columns | series 45     | 50               |
| F BL 7011 03 51                            | to the wooden worktops | series 45     | 50               |
| <b>Overall dimensions mm 952x210x810 h</b> |                        |               |                  |
| <b>Usable dimensions mm 905x150x581 h</b>  |                        |               |                  |

Hooks and tools excluded

■ 01 ■ 02 ■ 51 ■ 56



| ORD. NO.                                    | FIXING TYPE            | CYLINDER LOCK | LOAD CAPACITY kg |
|---|------------------------|---------------|------------------|
| F BL 7021 01 51                             | to the wall            | series 45     | 50               |
| F BL 7021 03 51                             | to the wooden worktops | series 45     | 50               |
| <b>Overall dimensions mm 952x210x1115 h</b> |                        |               |                  |
| <b>Usable dimensions mm 905x150x885 h</b>   |                        |               |                  |

Hooks and tools excluded

■ 01 ■ 02 ■ 51 ■ 56

### WINDER



#### ORD. NO. F BL 9601 01 07

IP42 230V winder with 10 metres of cable 3x1,5 mm<sup>2</sup> complete with a heavy duty flying socket 220-250V 16A 2P+GND and a Schuko socket 220-250V 10A 2P+GND. The winder is fitted with a bracket for connection to the support columns with dual slots.

#### Power output:

with cable wound up 1200W  
with cable unwound 1800W



## SERIES WORK-LOOK

## PHILIPS LAMP IP 66

**Structure:** Casing in polyester, cover in transparent polycarbonate

■ 08



| ORD. NO.                 | DIMENSIONS mm |
|--------------------------|---------------|
| <b>F BL 9905 00 00</b>   | 700x140x85 h  |
| Fixing material included |               |

**Technical specifications of lamp:**

|                   |           |                        |          |
|-------------------|-----------|------------------------|----------|
| Protected to:     | IP 66     | Length of cable:       | 4 metres |
| Neon:             | 2x18W     | Tonality:              | 4000K    |
| Electrical input: | 230V/50Hz | Colour rendering (Ra): | 80-89    |
| Plug:             | Schuko    |                        |          |

**Structure:** Casing in polyester, cover in transparent polycarbonate

■ 08

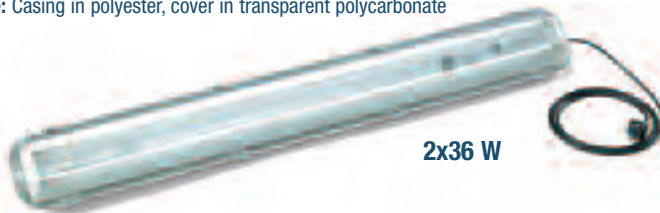

| ORD. NO.                 | DIMENSIONS mm |
|--------------------------|---------------|
| <b>F BL 9910 00 00</b>   | 1300x165x95 h |
| Fixing material included |               |

**Technical specifications of lamp:**

|                   |           |                        |          |
|-------------------|-----------|------------------------|----------|
| Protected to:     | IP 66     | Length of cable:       | 4 metres |
| Neon:             | 2x36W     | Tonality:              | 4000K    |
| Electrical input: | 230V/50Hz | Colour rendering (Ra): | 80-89    |
| Plug:             | Schuko    |                        |          |

**Structure:** Casing in polyester, cover in transparent polycarbonate

■ 08

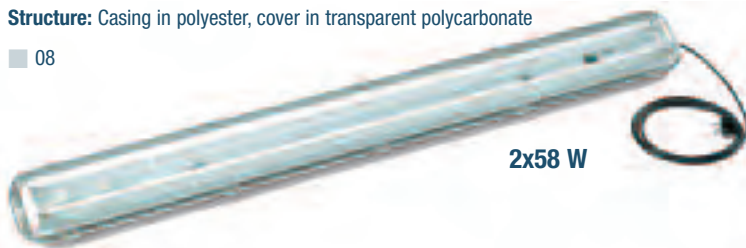

| ORD. NO.                 | DIMENSIONS mm |
|--------------------------|---------------|
| <b>F BL 9915 00 00</b>   | 1600x165x95 h |
| Fixing material included |               |

**Technical specifications of lamp:**

|                   |           |                        |          |
|-------------------|-----------|------------------------|----------|
| Protected to:     | IP 66     | Length of cable:       | 4 metres |
| Neon:             | 2x58W     | Tonality:              | 4000K    |
| Electrical input: | 230V/50Hz | Colour rendering (Ra): | 80-89    |
| Plug:             | Schuko    |                        |          |

## ANTI-GLARE HOOD FOR PHILIPS LAMP

■ 08



| ORD. NO.               | FOR LAMP |
|------------------------|----------|
| <b>F BL 9921 00 08</b> | 2x18 W   |
| <b>F BL 9922 00 08</b> | 2x36 W   |

## WALDMANN LAMP 2x36 W IP 67

**Structure:** Glass tube, parabolic diffuser



| ORD. NO.                 | DIAMETER mm | LENGTH mm |
|--------------------------|-------------|-----------|
| <b>F BL 9960 00 00</b>   | 70          | 1090      |
| Fixing material included |             |           |

**Technical specifications of lamp:**

|                   |           |                        |       |
|-------------------|-----------|------------------------|-------|
| Protected to:     | IP 67     | Length of cable:       | 4 m   |
| Neon:             | 2x36W     | Tonality:              | 4000K |
| Electrical input: | 230V/50Hz | Colour rendering (Ra): | 80-89 |
| Plug:             | Schuko    |                        |       |

## WALDMANN LAMP 2x36 W IP 20

**Structure:** Casing in aluminium, metallic parabolic diffuser

■ 08

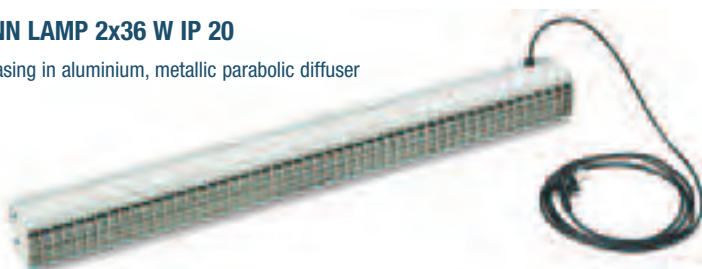

| ORD. NO.                 | DIMENSIONS mm |
|--------------------------|---------------|
| <b>F BL 9930 00 08</b>   | 910x90x105 h  |
| Fixing material included |               |

**Technical specifications of lamp:**

|                   |           |                        |        |
|-------------------|-----------|------------------------|--------|
| Protected to:     | IP 20     | Length of cable:       | 2,95 m |
| Neon:             | 2x36W     | Tonality:              | 4000K  |
| Electrical input: | 230V/50Hz | Colour rendering (Ra): | 80-89  |
| Plug:             | Schuko    |                        |        |





■ RAL 5012

**WORKSTATION**

**ORD. NO.**

**F BI A528 S3 04**

**Dimensions mm 1300x800x850/2120 h**

Tools and boxes excluded

**TRIPLE-JOINTED WALDMANN LAMP 1x36 W IP 20**

**Structure:** Casing in aluminium, metallic parabolic diffuser

■ 08

**ORD. NO. F BL 9980 00 08**

**The standard lighting system includes:**

1 multi-purpose steel support for fixing the lamp

1 clamp 0–65 mm

1 triple-jointed lamp

**Technical specifications of lamp:**

|                   |           |                        |        |
|-------------------|-----------|------------------------|--------|
| Protected to:     | IP 20     | Length of cable:       | 1,95 m |
| Neon:             | 1x36W     | Tonality:              | 4000K  |
| Electrical input: | 230V/50Hz | Colour rendering (Ra): | 80-89  |
| Plug:             | Schuko    |                        |        |

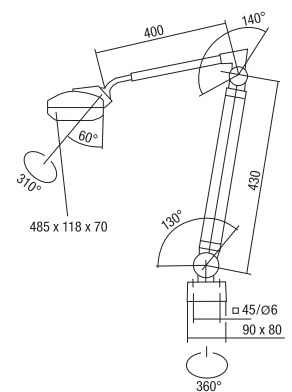

The multi-purpose steel support (supplied standard with the lamp) is used to fix the lamp to the support column with dual slots.



■ RAL 5012

**WORKSTATION**

**ORD. NO. F BH A328 S3 04**

**Dimensions mm 1300x800x840/2110 h**

Tools, boxes and electrical equipment excluded



■ RAL 5012

**WORKSTATION**

**ORD. NO. F BH A342 S2 04**

**Dimensions mm 1500x800x840/2110 h**

Tools and sets of partitioning material for drawers excluded

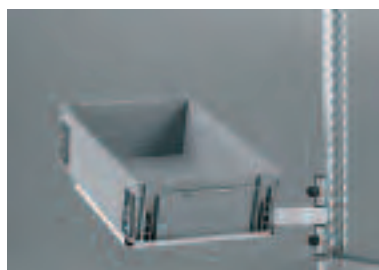
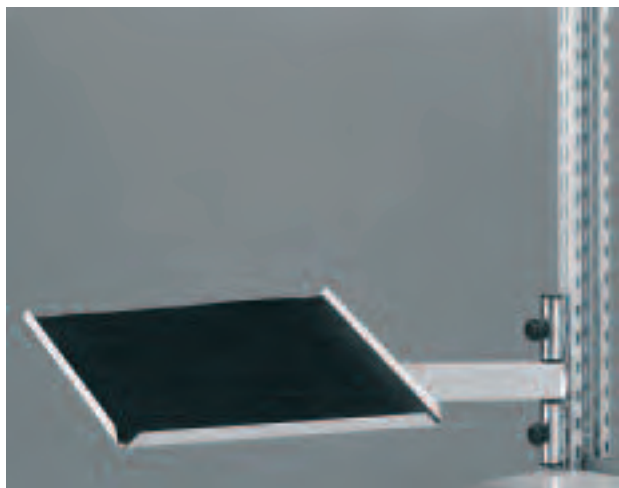

**SWIVEL ARM WITH TWO JOINTS WITH INCLINED TRAY****ORD. NO.****F BL 7456 00 08**

Complete with screw brakes with knob

Internal dim. of tray 401x402x21 mm h

**SWIVEL ARM WITH TWO JOINTS WITH BOXES****ORD. NO.****F BL 7445 03 08**Complete with 5 grey boxes size 1 and  
3 grey boxes size 2

Load capacity 15 kg

**SWIVEL ARM WITH TWO JOINTS WITH BOXES****ORD. NO.****F BL 7445 04 08**

Complete with 15 grey boxes size 1

Load capacity 15 kg

**SWIVEL ARM WITH TWO JOINTS WITH TRAY****ORD. NO.****F BL 7455 00 08**

Complete with screw brakes with knob

Load capacity 20 kg

**SWIVEL ARM WITH TWO JOINTS WITH PRACTIBOX****ORD. NO.****F BL 7446 01 08**Complete with 1 practibox drawer unit with 9 drawers and  
2 practibox drawer units with 6 drawers

Load capacity 15 kg

RAL 7000 F. ....01

RAL 6011 F. ....02

RAL 5012 F. ....04

RAL 7035 F. ....08

**KEY ■**

- All indicated loads are net and refer to evenly distributed weights





■ Power panelling see page D74



■ Multiple socket box see page D75



■ Pneumatic system see page D71

■ INFO



[www.famispa.com](http://www.famispa.com)

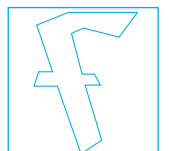
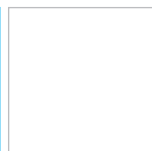
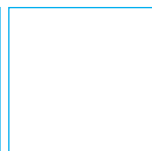



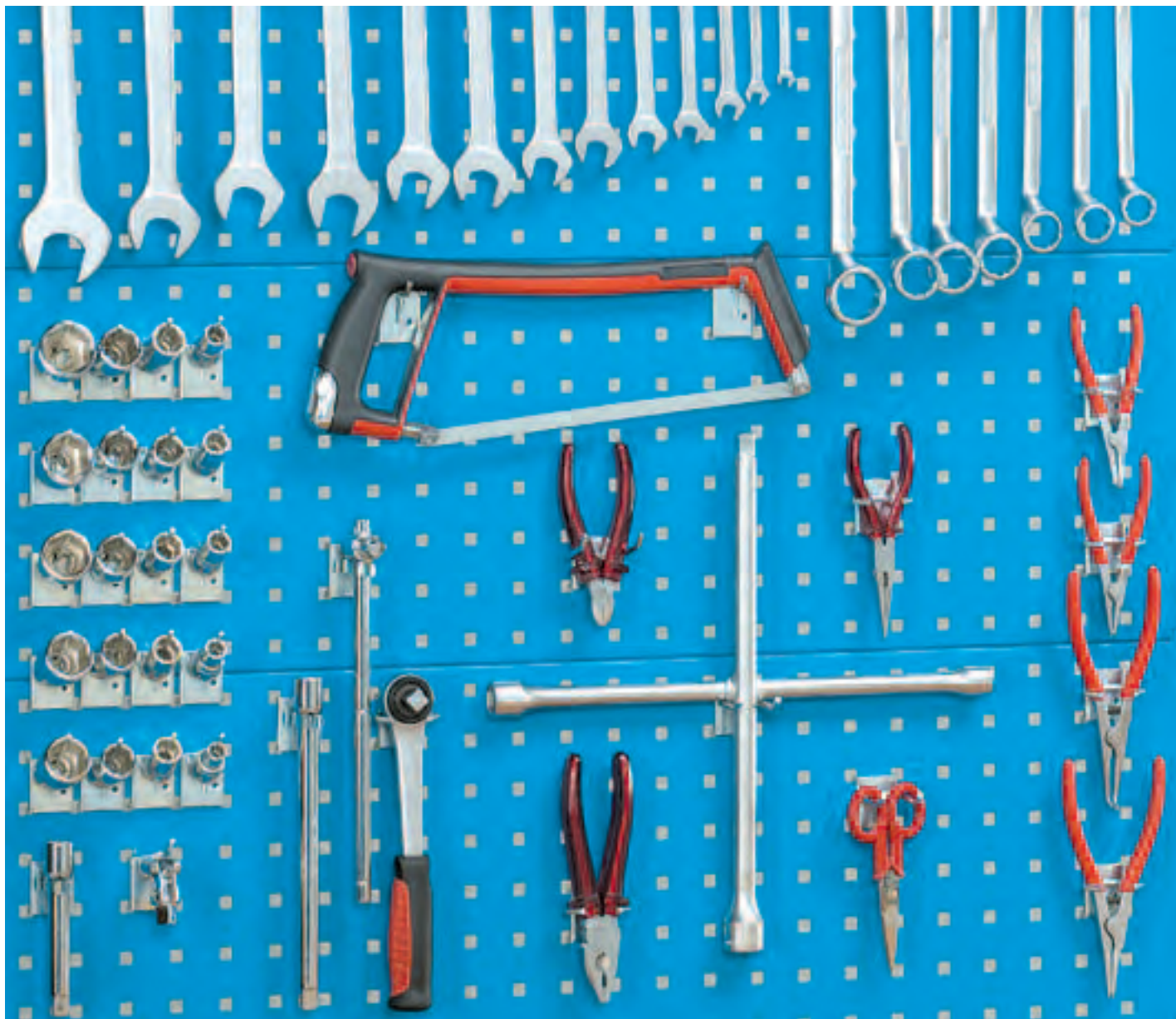

SET OF HOOKS AND BOXES

■ 01 ■ 02 ■ 03 ■ 04 ■ 05

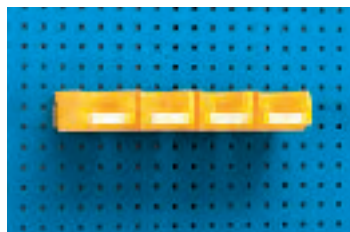

**ORD. NO. F BL 9504 00 05**

Set of 4 boxes size 1  
complete with bracket for connection  
to the perforated back panels  
Dimensions mm 450x160x75 h



**ORD. NO. F BL 9507 00 05**

Set of 3 boxes size 2  
complete with bracket for connection  
to the perforated back panels  
Dimensions mm 450x230x130 h



**ORD. NO. F BL 9508 00 99**

Set of 6 hooks (tools excluded)  
including:  
no. 2 C MV 10 022, no. 1 C MV 10 003  
no. 1 C MV 10 036, no. 2 C MV 10 001

GREY PL F. ....01 ■ GREEN PL F. ....02 ■ RED PL F. ....03 ■ BLUE PL F. ....04 ■ YELLOW PL F. ....05

INFO ■

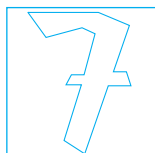

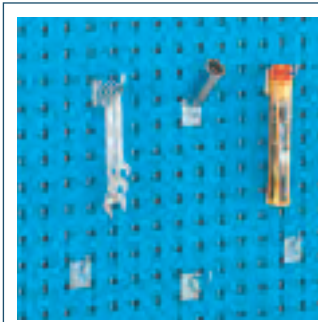

**SINGLE HOOK**

| ORD. NO.    | Ø | L  |
|-------------|---|----|
| C MV 10 035 | 6 | 10 |
| C MV 10 036 | 6 | 50 |

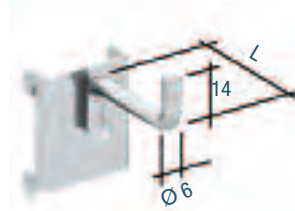

99

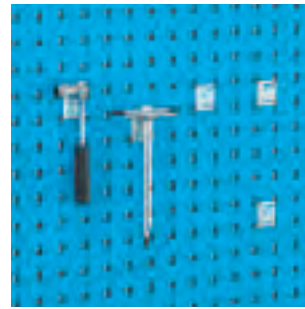

**FLEXIBLE HOOK**

| ORD. NO.    | L  | B  |
|-------------|----|----|
| C MV 10 002 | 28 | 9  |
| C MV 10 003 | 33 | 17 |

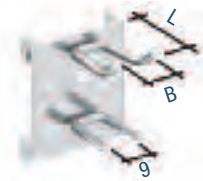

99

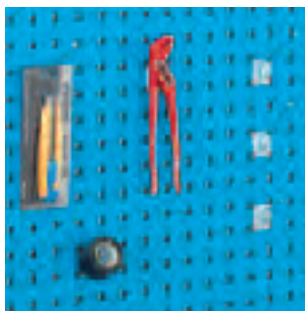

**ANGLE SINGLE HOOK**

| ORD. NO.    | Ø | L   |
|-------------|---|-----|
| C MV 10 014 | 4 | 50  |
| C MV 10 015 | 6 | 100 |

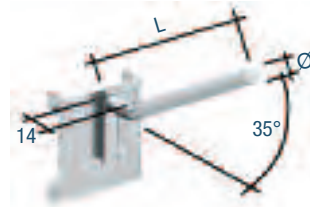

99



**ROUND HOOK**

| ORD. NO.    | Ø  |
|-------------|----|
| C MV 10 030 | 60 |
| C MV 10 032 | 80 |



99



**ANGLE HOOK**

| ORD. NO.    | Ø | L  | B  |
|-------------|---|----|----|
| C MV 10 016 | 5 | 50 | 40 |



99

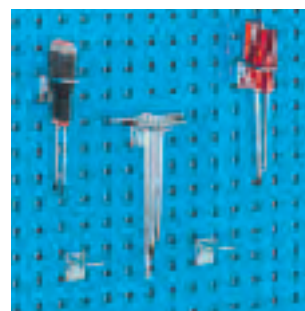

**CLOSED DOUBLE HOOK**

| ORD. NO.    | Ø | L  | B  |
|-------------|---|----|----|
| C MV 10 004 | 5 | 70 | 25 |



99

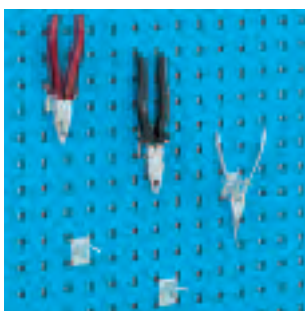

**LEVEL HOOK**

| ORD. NO.    | Ø | L  | B  |
|-------------|---|----|----|
| C MV 10 001 | 5 | 20 | 43 |



99

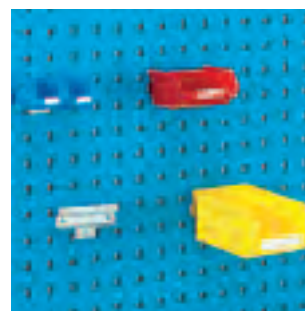

**HOOK FOR BOXES  
SIZE 01 - 0 - 1**

| ORD. NO.    | A | L | B  |
|-------------|---|---|----|
| C MV 10 026 | 9 | 9 | 40 |

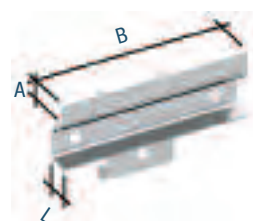

99

■ INFO

GALVANISED F.....99



[www.famispa.com](http://www.famispa.com)

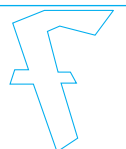



SERIES WORK-LOOK

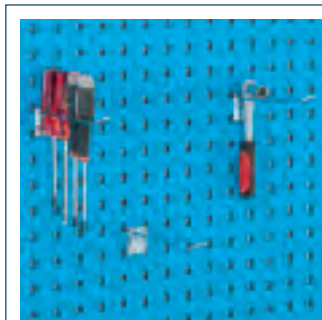

**FIXING CLAMP**

| ORD. NO.    | Ø   | L   | B  |
|-------------|-----|-----|----|
| C MV 10 027 | 3,5 | 170 | 29 |

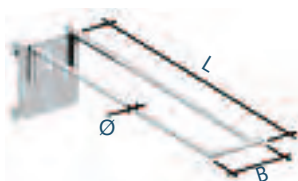

■ 99

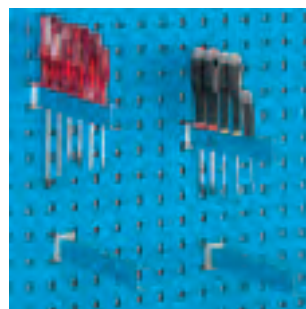

**SCREW DRIVER HOOK**

| ORD. NO.    | Ø  | L   | B  |
|-------------|----|-----|----|
| C MV 10 018 | 12 | 220 | 32 |



■ 99

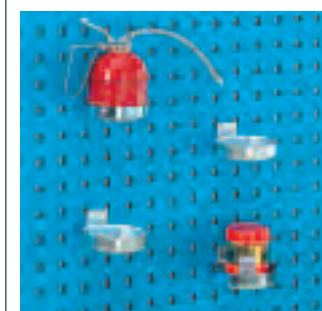

**CONTAINER HOOK**

| ORD. NO.    | Ø  | L  |
|-------------|----|----|
| C MV 10 017 | 82 | 30 |



■ 99

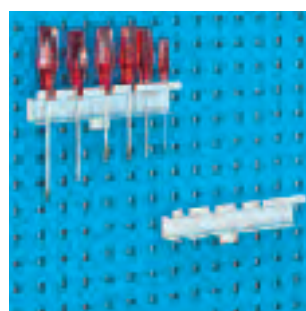

**SPRING CLIP**

| ORD. NO.    | L   | B  |
|-------------|-----|----|
| C MV 10 019 | 238 | 40 |

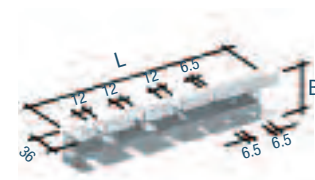

■ 99

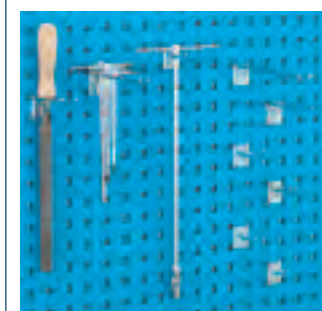

**DOUBLE HOOK**

| ORD. NO.    | Ø | L   | B  |
|-------------|---|-----|----|
| C MV 10 005 | 5 | 38  | 7  |
| C MV 10 006 | 5 | 38  | 11 |
| C MV 10 007 | 5 | 55  | 25 |
| C MV 10 008 | 5 | 64  | 7  |
| C MV 10 009 | 5 | 64  | 11 |
| C MV 10 010 | 5 | 100 | 25 |
| C MV 10 011 | 5 | 150 | 10 |
| C MV 10 012 | 5 | 150 | 25 |
| C MV 10 013 | 5 | 200 | 15 |

■ 99



**SUSPENSION HOOK**

| ORD. NO.    | Ø | L   |
|-------------|---|-----|
| C MV 10 037 | 5 | 24  |
| C MV 10 038 | 5 | 38  |
| C MV 10 039 | 4 | 100 |
| C MV 10 040 | 6 | 100 |
| C MV 10 041 | 5 | 150 |
| C MV 10 042 | 6 | 200 |

■ 99

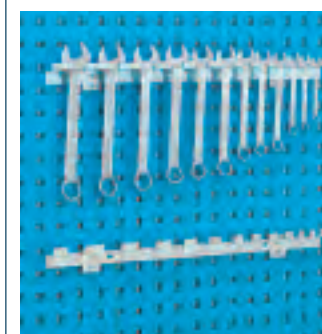

**KEY HOOK**

| ORD. NO.    | L   |
|-------------|-----|
| C MV 10 025 | 556 |

■ 99

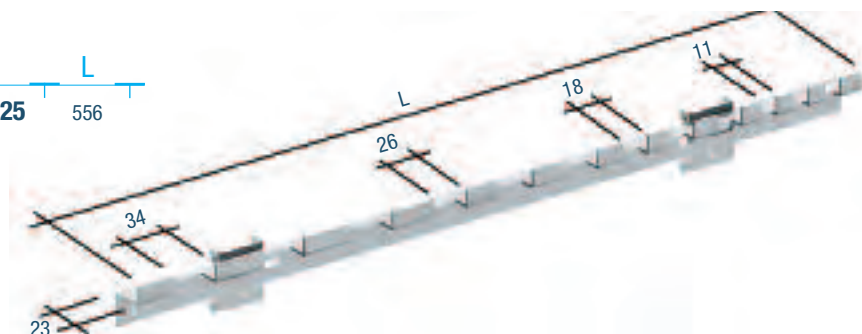

GALVANISED F... ..99

INFO ■

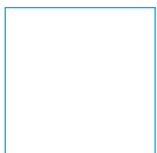
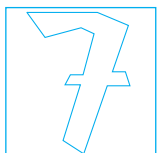

[www.famispa.com](http://www.famispa.com)

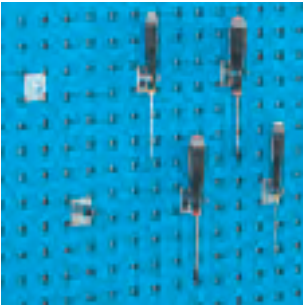

**SPRING CLIP**

| ORD. NO.    | Ø  |
|-------------|----|
| C MV 10 020 | 6  |
| C MV 10 021 | 12 |
| C MV 10 022 | 18 |
| C MV 10 023 | 25 |



99



**CLOSED FLEXIBLE HOOK**

| ORD. NO.    | Ø  |
|-------------|----|
| C MV 10 029 | 40 |
| C MV 10 031 | 60 |
| C MV 10 033 | 80 |



99

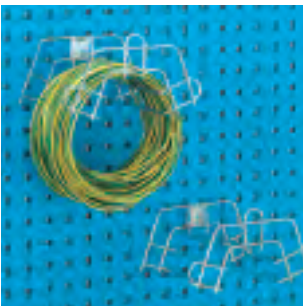

**CABLE HOOK**

| ORD. NO.    | L   | B   | Ø |
|-------------|-----|-----|---|
| C MV 10 024 | 160 | 125 | 5 |

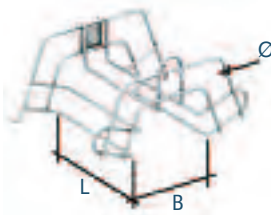

99

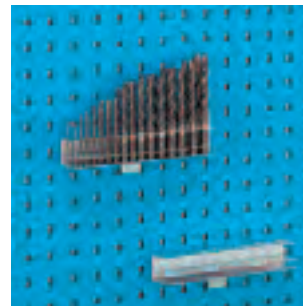

**BIT HOOK**

| ORD. NO.    | A  | L   | B    |
|-------------|----|-----|------|
| C MV 10 028 | 40 | 238 | 42,5 |



99



**SHELF**

| ORD. NO.    | A  | L   | B   |
|-------------|----|-----|-----|
| C MV 10 043 | 10 | 350 | 120 |

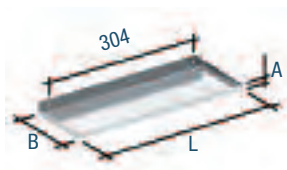

99

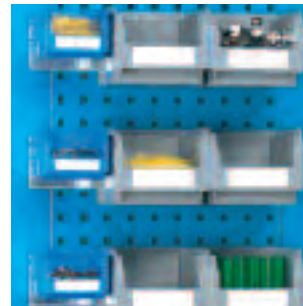

**CONTAINER'S RAIL  
SIZE 1/ SIZE 2**

| ORD. NO.        | A  | L   | B |
|-----------------|----|-----|---|
| F BL 7438 00 99 | 86 | 445 | - |



99

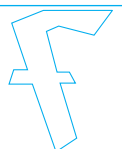



SERIES WORK-LOOK

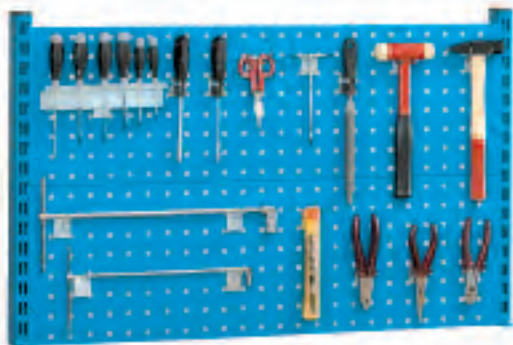

- 01
- 02
- 04
- 08

Including:

- no. 1 **C MV 10 019**
- no. 3 **C MV 10 001**
- no. 3 **C MV 10 022**
- no. 1 **C MV 10 003**
- no. 1 **C MV 10 007**
- no. 2 **C MV 10 016**
- no. 4 **C MV 10 036**
- no. 1 **C MV 10 014**

ORD. NO.

**F BL 9502 00 99**

Set of 16 galvanised hooks  
**without** panels and support  
columns

Tools excluded

ORD. NO.

**F BL A010 18 04**

Set of 16 galvanised hooks  
**with** panels and support  
columns ■ RAL 5012

Tools excluded

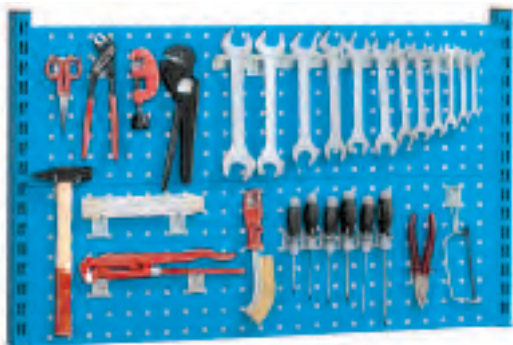

- 01
- 02
- 04
- 08

Including:

- no. 1 **C MV 10 016**
- no. 7 **C MV 10 037**
- no. 2 **C MV 10 038**
- no. 1 **C MV 10 001**
- no. 1 **C MV 10 007**
- no. 2 **C MV 10 021**
- no. 4 **C MV 10 022**
- no. 1 **C MV 10 025**

ORD. NO.

**F BL 9512 00 99**

Set of 19 galvanised hooks  
**without** panels and support  
columns

Tools excluded

ORD. NO.

**F BL A010 21 04**

Set of 19 galvanised hooks  
**with** panels and support  
columns ■ RAL 5012

Tools excluded

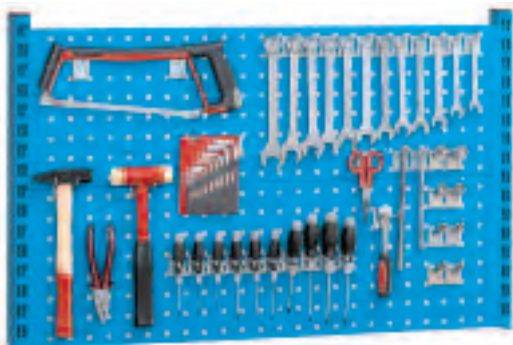

- 01
- 02
- 04
- 08

Including:

- no. 1 **C MV 10 016**
- no. 3 **C MV 10 007**
- no. 24 **C MV 10 037**
- no. 1 **C MV 10 001**
- no. 8 **C MV 10 021**
- no. 4 **C MV 10 022**

ORD. NO.

**F BL 9511 00 99**

Set of 41 galvanised hooks  
**without** panels and support  
columns

Tools excluded

ORD. NO.

**F BL A010 20 04**

Set of 41 galvanised hooks  
**with** panels and support  
columns ■ RAL 5012\*

Tools excluded



- 01
- 02
- 04
- 08

ORD. NO.

**F BL 9516 00 99**

Set of 19 galvanised hooks  
**without** panels and support  
columns

Tools excluded

ORD. NO.

**F BL A020 27 04**

Set of 19 galvanised hooks  
**with** panels and support  
columns ■ RAL 5012

Tools excluded

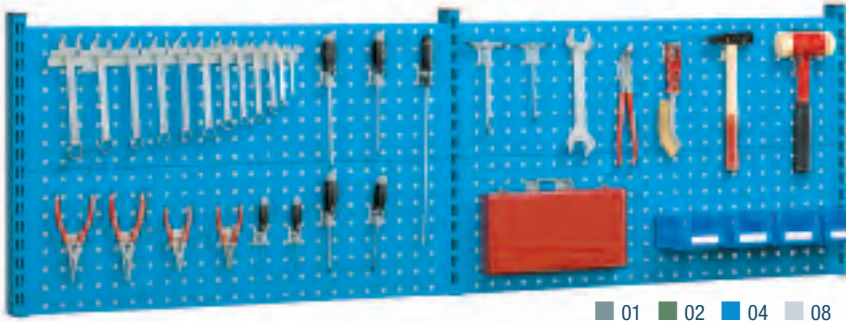

- 01
- 02
- 04
- 08

ORD. NO.

**F BL 9522 00 99**

Set of 22 galvanised hooks  
**without** panels and support  
columns

Tools excluded

ORD. NO.

**F BL A020 33 04**

Set of 22 galvanised hooks  
**with** panels and support  
columns ■ RAL 5012

Tools excluded

Including:

- no. 3 **C MV 10 037**
- no. 1 **C MV 10 036**
- no. 2 **C MV 10 002**
- no. 3 **C MV 10 016**
- no. 4 **C MV 10 001**
- no. 2 **C MV 10 020**
- no. 5 **C MV 10 022**
- no. 1 **C MV 10 025**
- no. 4 **F PM1751 00 04**
- no. 1 **F BL 7438 00 99**
- no. 4 **F PM1751 00 05**
- no. 3 **F PM2551 00 05**
- no. 2 **F BL 7448 00 99**
- no. 1 **C MV 10 017**

RAL 7000 F. ....01 RAL 6011 F. ....02 RAL 5012 F. ....04 RAL 7035 F. ....08

KEY ■

■ The support columns are 632 high, the panels are 1000 mm long and can be fitted to wooden worktops only.

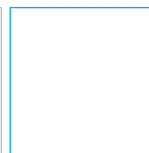
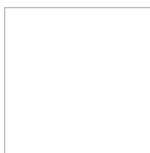
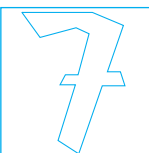



01 02 04 08

ORD. NO.

**F BL 9524 00 99**

Set of 117 galvanised hooks  
**without** panels and support  
columns

Tools excluded

ORD. NO.

**F BL A020 35 04**

Set of 117 galvanised hooks  
**with** panels and support  
columns ■ RAL 5012

Tools excluded

Including:

- |                          |                          |
|--------------------------|--------------------------|
| no.61 <b>C MV 10 037</b> | no. 2 <b>C MV 10 016</b> |
| no. 1 <b>C MV 10 025</b> | no.11 <b>C MV 10 022</b> |
| no. 5 <b>C MV 10 007</b> | no. 1 <b>C MV 10 017</b> |
| no. 6 <b>C MV 10 023</b> | no. 2 <b>C MV 10 001</b> |
| no.12 <b>C MV 10 021</b> | no.16 <b>C MV 10 014</b> |

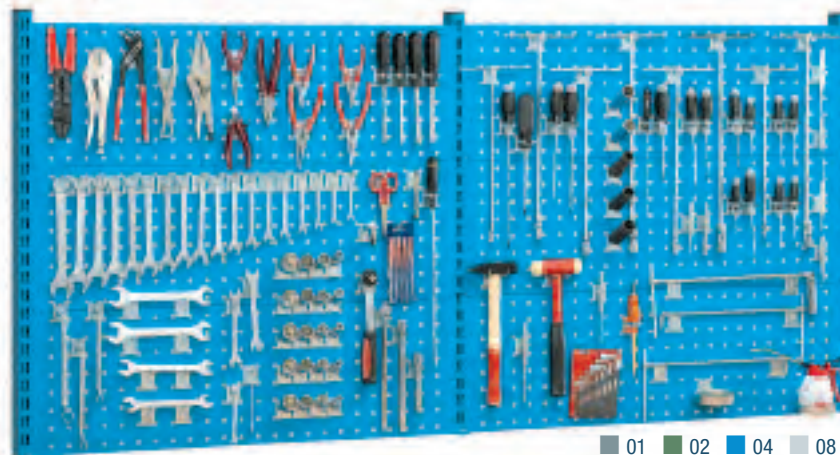

01 02 04 08

ORD. NO.

**F BL 9523 00 99**

Set of 84 galvanised hooks  
**without** panels and support  
columns

Tools excluded

ORD. NO.

**F BL A020 34 04**

Set of 84 galvanised hooks  
**with** panels and support  
columns ■ RAL 5012

Tools excluded

Including:

- |                          |                          |
|--------------------------|--------------------------|
| no.34 <b>C MV 10 037</b> | no.16 <b>C MV 10 023</b> |
| no. 2 <b>C MV 10 007</b> | no. 6 <b>C MV 10 014</b> |
| no. 2 <b>C MV 10 006</b> | no. 7 <b>C MV 10 022</b> |
| no. 1 <b>C MV 10 005</b> | no. 5 <b>C MV 10 021</b> |
| no. 4 <b>C MV 10 016</b> | no. 1 <b>C MV 10 020</b> |
| no. 6 <b>C MV 10 001</b> |                          |



01  
02  
04  
08

ORD. NO.

**F BL 9526 00 99**

Set of 141 galvanised hooks  
**without** panels and support  
columns

Tools excluded

ORD. NO.

**F BL A030 17 04**

Set of 141 galvanised hooks  
**with** panels and support  
columns ■ RAL 5012

Tools excluded

Including:

- |                          |                          |                          |
|--------------------------|--------------------------|--------------------------|
| no. 2 <b>C MV 10 017</b> | no.58 <b>C MV 10 037</b> | no.23 <b>C MV 10 014</b> |
| no. 1 <b>C MV 10 025</b> | no.19 <b>C MV 10 021</b> | no.12 <b>C MV 10 022</b> |
| no. 3 <b>C MV 10 007</b> | no. 9 <b>C MV 10 001</b> | no. 9 <b>C MV 10 023</b> |
| no. 2 <b>C MV 10 036</b> | no. 2 <b>C MV 10 016</b> | no. 1 <b>C MV 10 020</b> |

■ KEY

- |                    |                    |                    |                    |
|--------------------|--------------------|--------------------|--------------------|
| RAL 7000 F. ....01 | RAL 6011 F. ....02 | RAL 5012 F. ....04 | RAL 7035 F. ....08 |
|--------------------|--------------------|--------------------|--------------------|



■ The support columns are 936 high, the panels are 1000 mm long and can be fitted to wooden worktops only.





## SERIES WORK-STEEL

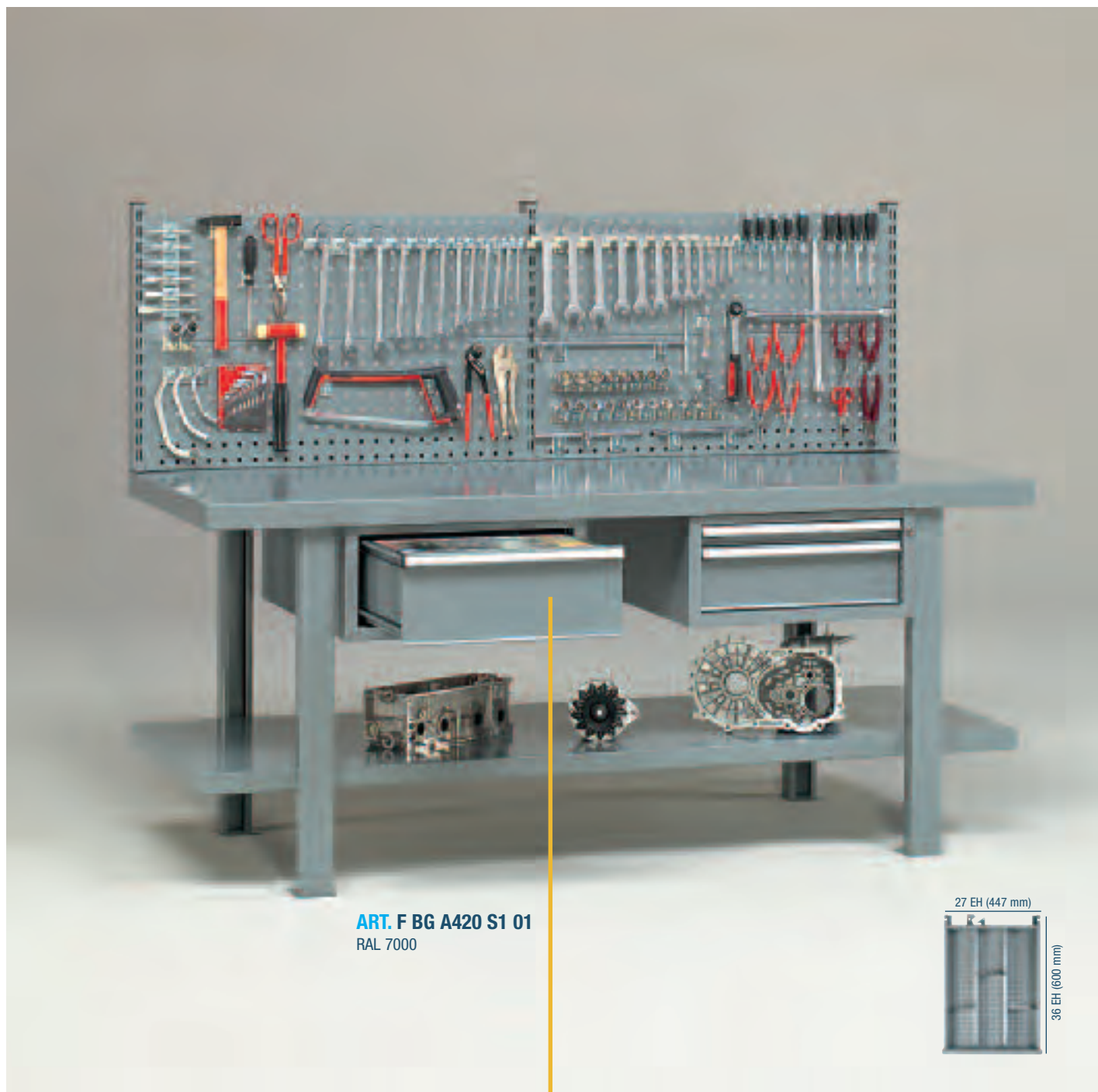

**ART. F BG A420 S1 01**  
RAL 7000

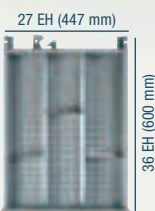
**WORKSTATION****ORD. NO.****F BG A420 S1 01**

Complete with multi-purpose back panels

**Dimensions mm 2000/800x880/1515 h**

Tools and set of partitioning material for drawers excluded

**SET OF PARTITIONING MATERIAL****ORD. NO.****F FH 8610 21 00**for 27x36 Eh drawer with  
200 mm h front

RAL 7000 F. ....01

RAL 6011 F. ....02

RAL 5012 F. ....04

**SUPPLEMENTARY PARTS ■**

■ Set of  
partitions see  
page A72 -  
A73



■ **Spare key.** Always indicate the number on the cylinder lock of the key to be replaced.

ORD. NO. R CSC 0002 00

■ **Master key.** This type of key opens all the 45 and 46 series locks.

ORD. NO. R CSC 0001 00



STEEL WORKSTATIONS 1200x750x880 mm h

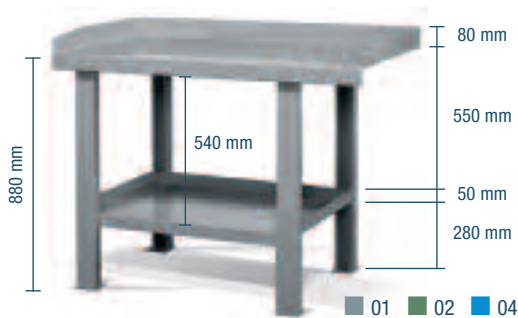

| ORD. NO.                     | TYPE OF WORKTOP | WORKTOP LOAD CAPACITY kg | LOWER SHELF LOAD CAPACITY kg |
|------------------------------|-----------------|--------------------------|------------------------------|
| <b>F BG A120 00 01</b>       | Steel           | 2000                     | 350                          |
| Dimensions mm 1200x750x880 h |                 |                          |                              |



| ORD. NO.                     | TYPE OF WORKTOP | WORKTOP LOAD CAPACITY kg | LOWER SHELF LOAD CAPACITY kg |
|------------------------------|-----------------|--------------------------|------------------------------|
| <b>F BG A120 01 01</b>       | Steel           | 2000                     | 350                          |
| Complete with drawer unit    |                 |                          |                              |
| Dimensions mm 1200x750x880 h |                 |                          |                              |

STEEL WORKSTATIONS 1500x750x880 mm h

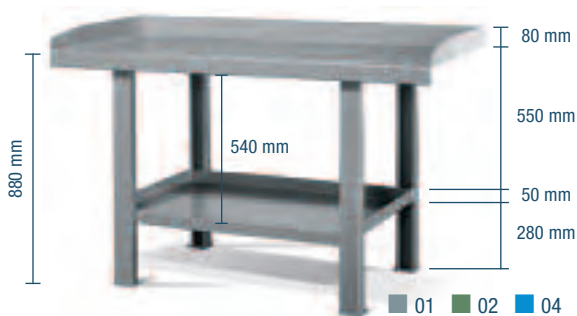

| ORD. NO.                     | TYPE OF WORKTOP | WORKTOP LOAD CAPACITY kg | LOWER SHELF LOAD CAPACITY kg |
|------------------------------|-----------------|--------------------------|------------------------------|
| <b>F BG A220 00 01</b>       | Steel           | 2000                     | 350                          |
| Dimensions mm 1500x750x880 h |                 |                          |                              |



| ORD. NO.                     | TYPE OF WORKTOP | WORKTOP LOAD CAPACITY kg | LOWER SHELF LOAD CAPACITY kg |
|------------------------------|-----------------|--------------------------|------------------------------|
| <b>F BG A220 01 01</b>       | Steel           | 2000                     | 350                          |
| Complete with drawer unit    |                 |                          |                              |
| Dimensions mm 1500x750x880 h |                 |                          |                              |

KEY

RAL 7000 F. ....01 RAL 6011 F. ....02 RAL 5012 F. ....04



All indicated loads are net and refer to evenly distributed weights

Set of partitions see page A72 - A73

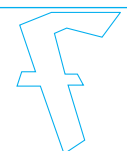

SERIES WORK

STEEL WORKSTATIONS 1500x800x880/1515 mm h



| ORD. NO.               | TYPE OF WORKTOP | WORKTOP LOAD CAPACITY kg | LOWER SHELF LOAD CAPACITY kg |
|------------------------|-----------------|--------------------------|------------------------------|
| <b>F BG A320 00 01</b> | Steel           | 2000                     | 350                          |

Dimensions mm 1500x800x880/1515 h



| ORD. NO.               | TYPE OF WORKTOP | WORKTOP LOAD CAPACITY kg | LOWER SHELF LOAD CAPACITY kg |
|------------------------|-----------------|--------------------------|------------------------------|
| <b>F BG A320 01 01</b> | Steel           | 2000                     | 350                          |

Complete with drawer unit  
Dimensions mm 1500x800x880/1515 h

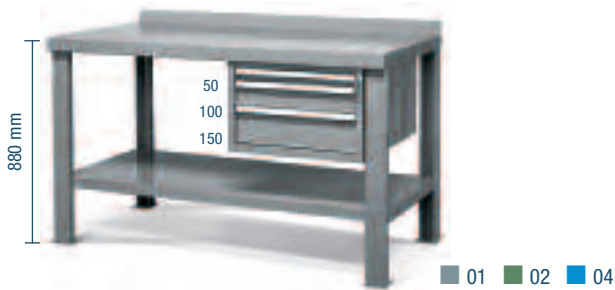

| ORD. NO.               | TYPE OF WORKTOP | WORKTOP LOAD CAPACITY kg | LOWER SHELF LOAD CAPACITY kg |
|------------------------|-----------------|--------------------------|------------------------------|
| <b>F BG A320 03 01</b> | Steel           | 2000                     | 350                          |

Complete with drawer unit  
Dimensions mm 1500x800x880/1515 h

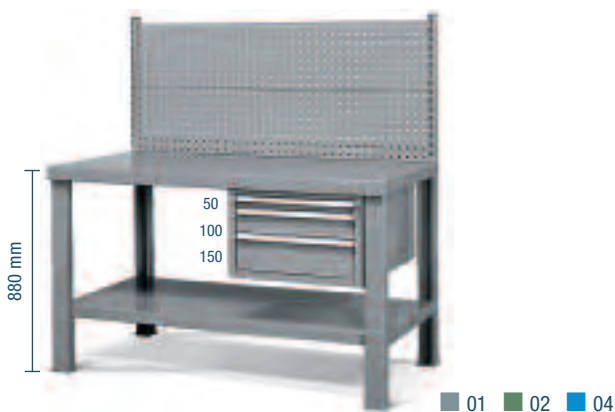

| ORD. NO.               | TYPE OF WORKTOP | WORKTOP LOAD CAPACITY kg | LOWER SHELF LOAD CAPACITY kg |
|------------------------|-----------------|--------------------------|------------------------------|
| <b>F BG A320 53 01</b> | Steel           | 2000                     | 350                          |

Complete with drawer unit and 2 perforated back panels total height 608 mm  
Dimensions mm 1500x800x880/1515 h

RAL 7000 F. ....01 RAL 6011 F. ....02 RAL 5012 F. ....04



■ Set of partitions see page A72 - A73

KEY ■

■ All indicated loads are net and refer to evenly distributed weights



STEEL WORKSTATIONS 2000x800x880/1515 mm h

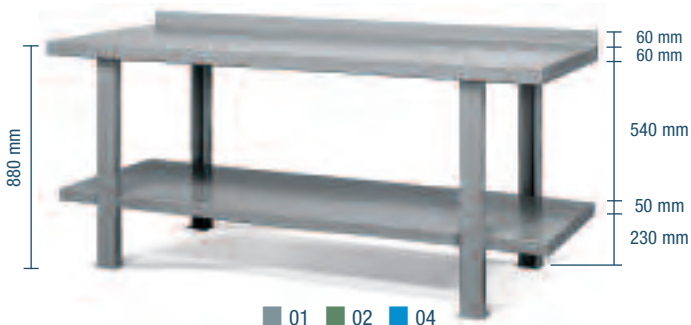

| ORD. NO.               | TYPE OF WORKTOP | WORKTOP LOAD CAPACITY kg | LOWER SHELF LOAD CAPACITY kg |
|------------------------|-----------------|--------------------------|------------------------------|
| <b>F BG A420 00 01</b> | Steel           | 2000                     | 350                          |

Dimensions mm 2000x800x880/1515 h

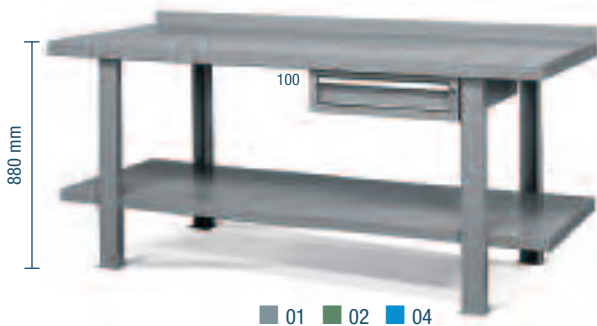

| ORD. NO.               | TYPE OF WORKTOP | WORKTOP LOAD CAPACITY kg | LOWER SHELF LOAD CAPACITY kg |
|------------------------|-----------------|--------------------------|------------------------------|
| <b>F BG A420 01 01</b> | Steel           | 2000                     | 350                          |

Complete with drawer unit  
Dimensions mm 2000x800x880/1515 h

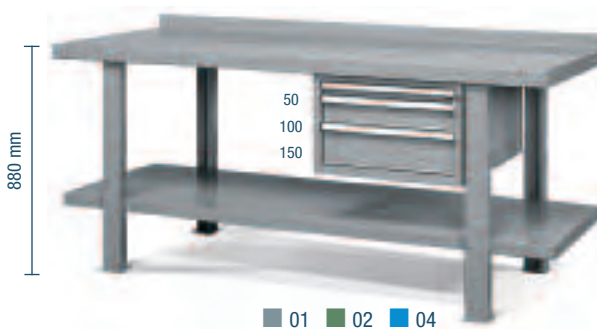

| ORD. NO.               | TYPE OF WORKTOP | WORKTOP LOAD CAPACITY kg | LOWER SHELF LOAD CAPACITY kg |
|------------------------|-----------------|--------------------------|------------------------------|
| <b>F BG A420 03 01</b> | Steel           | 2000                     | 350                          |

Complete with drawer unit  
Dimensions mm 2000x800x880/1515 h

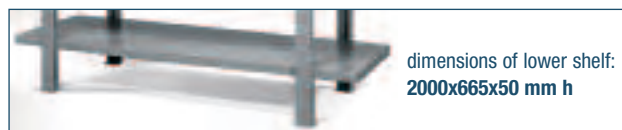
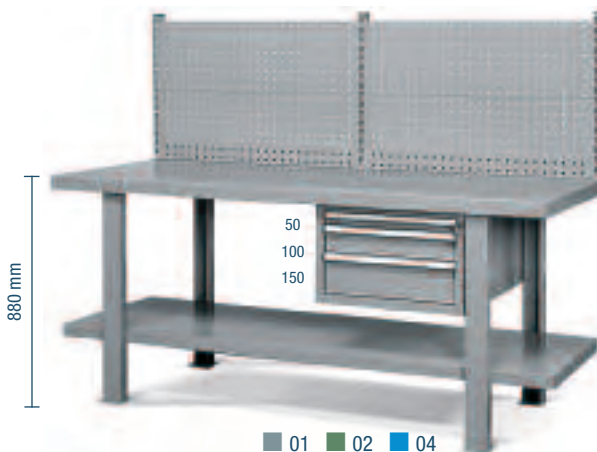

| ORD. NO.               | TYPE OF WORKTOP | WORKTOP LOAD CAPACITY kg | LOWER SHELF LOAD CAPACITY kg |
|------------------------|-----------------|--------------------------|------------------------------|
| <b>F BG A420 53 01</b> | Steel           | 2000                     | 350                          |

Complete with drawer unit and 4 perforated back panels total height 608 mm  
Dimensions mm 2000x800x880/1515 h

KEY

- RAL 7000 F. ....01
- RAL 6011 F. ....02
- RAL 5012 F. ....04



■ All indicated loads are net and refer to evenly distributed weights

■ Set of partitions see page A72 - A73

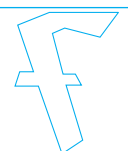



## SERIES WORK-SEAT

## BEECH-PLYWOOD CHAIRS



■ 07

**ORD. NO.****F QZ 1111 00 07**

Swivel chair with double swivel wheels, seat and back in beech-plywood.  
Seat height adjustable by screw.  
Height: from mm 530 to mm 645.



■ 07

**ORD. NO.****F QZ 1110 00 07**

Swivel chair with low noise floor feet, seat and back in beech-plywood.  
Seat height adjustable by screw.  
Height: from mm 501 to mm 620.



■ 07

**ORD. NO.****F QZ 1120 00 07**

Swivel chair with low noise floor feet and additional chromium-plated foot rest, height adjustable.  
Seat and back in beech-plywood.  
Seat height adjustable by screw.  
Height: from mm 501 to mm 710.

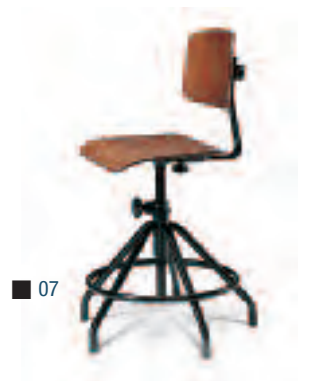

■ 07

**ORD. NO.****F QZ 1130 00 07**

Swivel chair with stationary base and painted foot rest.  
Seat and back in beech-plywood.  
Seat height adjustable by screw.  
Height: from mm 510 to mm 710.



■ 07

**ORD. NO.****F QZ 1211 00 07**

Swivel chair with double swivel wheels, seat and back in beech-plywood.  
Seat height adjustable by gas pump.  
Height: from mm 470 to mm 645.



■ 07

**ORD. NO.****F QZ 1210 00 07**

Swivel chair with low noise floor feet, seat and back in beech-plywood.  
Seat height adjustable by gas pump.  
Height: from mm 445 to mm 625.



■ 07

**ORD. NO.****F QZ 1220 00 07**

Swivel chair with low noise floor feet and additional chromium-plated foot rest, height adjustable.  
Seat and back in beech-plywood.  
Seat height adjustable by gas pump.  
Height: from mm 510 to mm 760.



■ 07

**ORD. NO.****F QZ 1310 00 07**

Swivel chair with low noise floor feet, seat and back in beech-plywood.  
Seat height adjustable by molomatic screw.  
Height: from mm 425 to mm 565.

## POLYURETHANE CHAIRS



■ 07

**ORD. NO.****F QZ 2211 00 07**

Swivel chair with double swivel wheels, seat and back in polyurethane.  
Seat height adjustable by gas pump.  
Height: from mm 495 to mm 670.



■ 07

**ORD. NO.****F QZ 2210 00 07**

Swivel chair with low noise floor feet, seat and back in polyurethane.  
Seat height adjustable by gas pump.  
Height: from mm 470 to mm 650.



■ 07

**ORD. NO.****F QZ 2220 00 07**

Swivel chair with low noise floor feet and foot rest.  
Seat and back in polyurethane.  
Seat height adjustable by gas pump.  
Height: from mm 535 to mm 785.



■ 07

**ORD. NO.****F QZ 2110 00 07**

Swivel chair with low noise floor feet and painted foot rest.  
Seat and back in polyurethane.  
Seat height adjustable by screw.  
Height: from mm 535 to mm 735.

STEEL VICES



front opening



front opening



front opening



rear opening

| STEEL VICE JAW WIDTH 80 mm |                |
|----------------------------|----------------|
| ORD. NO.                   | SUITABLE FOR   |
| FBL 1010 00 00             | Wooden worktop |
| FBL 1010 01 00             | Steel worktop  |
| A = 100 mm                 | D = 83 mm      |
| B = 330 mm                 | E = knurled    |
| C = 80 mm                  | G = 4 kg       |

| STEEL VICE JAW WIDTH 110 mm |                |
|-----------------------------|----------------|
| ORD. NO.                    | SUITABLE FOR   |
| FBL 1015 00 00              | Wooden worktop |
| FBL 1015 01 00              | Steel worktop  |
| A = 120 mm                  | D = 113 mm     |
| B = 385 mm                  | E = knurled    |
| C = 110 mm                  | G = 7 kg       |

| STEEL VICE JAW WIDTH 130 mm |                |
|-----------------------------|----------------|
| ORD. NO.                    | SUITABLE FOR   |
| FBL 1020 00 00              | Wooden worktop |
| FBL 1020 01 00              | Steel worktop  |
| A = 140 mm                  | D = 137 mm     |
| B = 430 mm                  | E = knurled    |
| C = 130 mm                  | G = 11 kg      |

| STEEL VICE JAW WIDTH 120 mm |                |
|-----------------------------|----------------|
| ORD. NO.                    | SUITABLE FOR   |
| FBL 1065 00 00              | Wooden worktop |
| FBL 1065 01 00              | Steel worktop  |
| A = 175 mm                  | D = 187 mm     |
| B = 510 mm                  | E = knurled    |
| C = 120 mm                  | G = 24 kg      |

CAST IRON VICES



rear opening



rear opening



rear opening

| *CAST IRON VICE JAW WIDTH 100 mm |                |
|----------------------------------|----------------|
| ORD. NO.                         | SUITABLE FOR   |
| FBL 1110 00 00                   | Wooden worktop |
| FBL 1110 01 00                   | Steel worktop  |
| A = 140 mm                       | D = 153 mm     |
| B = 445 mm                       | E = knurled    |
| C = 100 mm                       | G = 11 kg      |

| *CAST IRON VICE JAW WIDTH 120 mm |                |
|----------------------------------|----------------|
| ORD. NO.                         | SUITABLE FOR   |
| FBL 1120 00 00                   | Wooden worktop |
| FBL 1120 01 00                   | Steel worktop  |
| A = 185 mm                       | D = 180 mm     |
| B = 520 mm                       | E = knurled    |
| C = 120 mm                       | G = 18 kg      |

| **CAST IRON VICE JAW WIDTH 150 mm |                |
|-----------------------------------|----------------|
| ORD. NO.                          | SUITABLE FOR   |
| FBL 1130 00 00                    | Wooden worktop |
| FBL 1130 01 00                    | Steel worktop  |
| A = 220 mm                        | D = 210 mm     |
| B = 615 mm                        | E = knurled    |
| C = 150 mm                        | G = 25 kg      |

\* Cast iron vices can not be assembled on 30 mm thickness worktops.

\*\* For wooden worktops 50 mm h only.

A = maximum jaw opening    B = maximum width of vice    C = width of jaws    D = height of vice    E = knurled jaws    G = weight of vice

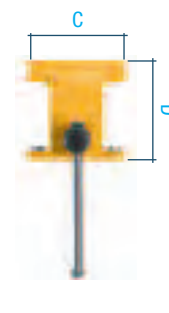
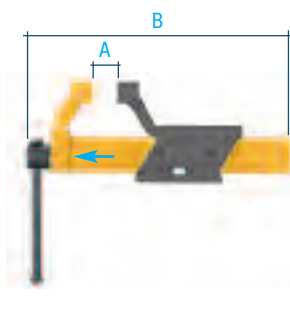
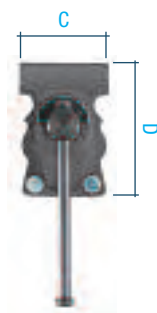
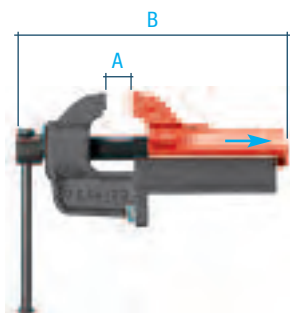

INFO



www.famispa.com

