

A close-up photograph of a hand holding a blue storage container. The background is dark, and the lighting highlights the texture of the hand and the ridges on the container. The text 'G SPACE' is overlaid on the left side of the image.

G SPACE

RETHINKING

- **STACKING AND STORAGE CONTAINERS SERIES STORAGE**

FOR ALL USES

UP TO 5 COLOURS AVAILABLE

STRONG AND RELIABLE THROUGH TIME

SUITABLE FOR CARRIAGE AND STORAGE

ON REQUEST CAN BE SUPPLIED SUITABLE TO STORE FOODSTUFFS

A close-up photograph of a hand holding a blue, rectangular storage case. The case is open, revealing a dark interior with a textured surface. The hand is positioned at the top and right edges of the case, with fingers gripping it. The background is solid black, which makes the blue case and the hand stand out. The lighting is dramatic, highlighting the contours of the hand and the texture of the case.

G SPACE

RETHINKING

SERIES STORAGE ATHENA

- FOR AUTOMATIC STORAGE SYSTEMS
- FOR AUTOMATIC HANDLING
- FOR MANUAL HANDLING
- SHOCK RESISTANT
- OIL RESISTANT



Resistant to high and low temperatures



Oil resistant



The stacking containers marked with this symbol can be used to store foodstuffs



ABS COVERS FOR ATHENA STACKING CONTAINERS



■ 07

ORD. NO.

DIM. mm

F VW 0006 00 07

1200x1000x70

Standard colour ■



Example of use of the cover and of the pallet



■ 07

ORD. NO.

DIM. mm

F VW 0007 00 07

1200x800x70

Standard colour ■

GREY
F. 01

BLACK
F. 07

KEY ■



The stacking containers marked with this symbol can be used to store foodstuffs.



Containers with this symbol are made of completely recyclable plastic material.



DIMENSIONS = 300x200 mm

SERIES STORAGE ATHENA

PLASTIC PALLETS

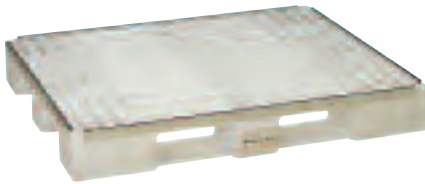

ORD. NO.	EXTERNAL DIM. mm
F PU 2240 00 13	1200x800x150 h
Load capacity on floor kg 4000	
Load capacity on fork lift truck kg 1500	
Weight kg	13,70

ORD. NO.	EXTERNAL DIM. mm
F PU 3240 00 13	1200x1000x150 h
Load capacity on floor kg 4000	
Load capacity on fork lift truck kg 1500	
Weight kg	16,70

Plastic pallets for **Athena** and **Thema** containers with galvanised steel edges on all 4 sides



ORD. NO.	DIM. mm
F PA 2451 A0 01	300x200x120 h
External dim. mm	300x200x120 h
Internal dim. mm	260x160x100 h
Capacity litres	5
Weight gr.	450
Standard colour*	■
Bottom	solid
Long sides	closed
Short sides	closed
Lifting	bars

Label holder: ORD. NO. **F PZ 0010 00 99**
See page G15

■ *On request other colours available



ORD. NO.	DIM. mm
F PA 2851 A0 01	300x200x170 h
External dim. mm	300x200x170 h
Internal dim. mm	258x160x154 h
Capacity litres	7
Weight gr.	670
Standard colour*	■
Bottom	solid
Long sides	closed
Short sides	closed
Lifting	bars

Label holder: ORD. NO. **F PZ 0010 00 99**
See page G15

■ *On request other colours available

TROLLEY WITH STACKING CONTAINERS

ORD. NO.	DIM. mm
F LB B103 53 52	1023x613x1430 h
Including:	
1 trolley ORD. NO. F LB B103 03 52	
2 standard rubber swivel wheels with brakes Ø 125 mm	
2 standard rubber fixed wheels Ø 125 mm	
3 shelves depth 420 mm	
5 stacking containers ORD. NO. F PA 4451 A0 01	
2 stacking containers ORD. NO. F PA 6451 A0 01	
2 stacking containers ORD. NO. F PA 6851 A0 01	
Load capacity 300 kg (150 kg per side)	

■ For any further information: see page D2



ORD. NO. **F LB B103 53 52**

KEY



The stacking containers marked with this symbol can be used to store foodstuffs.



Containers with this symbol are made of completely recyclable plastic material.



GREY
F.....01

SERIES STORAGE ATHENA

■ 01

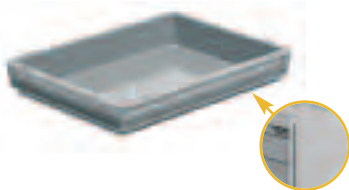
**ORD. NO.**

DIM. mm

F PA 3251 AO 01 400x300x55 h

External dim. mm 400x300x55 h

Internal dim. mm 355x254x37 h

Capacity litres 3,8

Weight gr. 505

Standard colour* ■

Bottom **solid**Long sides **closed**Short sides **closed**Lifting **bars**Label holder: ORD. NO. **F PZ 0010 00 99**

See page G15

■ 01

**ORD. NO.**

DIM. mm

F PA 3651 AO 01 400x300x78 h

External dim. mm 400x300x78 h

Internal dim. mm 355x255x59 h

Capacity litres 6

Weight gr. 550

Standard colour* ■

Bottom **solid**Long sides **closed**Short sides **closed**Lifting **bars**Label holder: ORD. NO. **F PZ 0010 00 99**

See pag. G15

■ 01

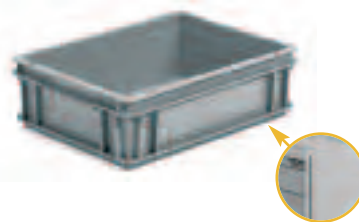
**ORD. NO.**

DIM. mm

F PA 4051 AO 01 400x300x120 h

External dim. mm 400x300x120 h

Internal dim. mm 357x257x102 h

Capacity litres 10

Weight gr. 770

Standard colour* ■

Bottom **solid**Long sides **closed**Short sides **closed**Lifting **bars**Label holder: ORD. NO. **F PZ 0010 00 99**

See pag. G15

■ 01

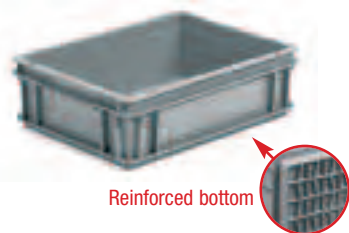
**ORD. NO.**

DIM. mm

F PA 4151 AO 01 400x300x125 h

External dim. mm 400x300x125 h

Internal dim. mm 357x256x94 h

Capacity litres 10

Weight gr. 1005

Standard colour* ■

Bottom **reinforced**Long sides **closed**Short sides **closed**Lifting **bars**Label holder: ORD. NO. **F PZ 0010 00 99**

See page G15

■ 01

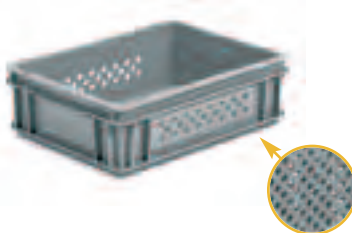
**ORD. NO.**

DIM. mm

F PA 4051 EO 01 400x300x120 h

External dim. mm 400x300x120 h

Internal dim. mm 357x256x99 h

Capacity litres 10

Weight gr. 820

Standard colour* ■

Bottom **perforated**Long sides **perforated**Short sides **closed**Lifting **bars**Label holder: ORD. NO. **F PZ 0010 00 99**

See page G15

■ 01

**ORD. NO.**

DIM. mm

F PA 4451 AO 01 400x300x170 h

External dim. mm 400x300x170 h

Internal dim. mm 357x257x152 h

Capacity litres 15

Weight gr. 1070

Standard colour* ■

Bottom **solid**Long sides **closed**Short sides **closed**Lifting **bars**Label holder: ORD. NO. **F PZ 0010 00 99**,
ORD. NO. **F PZ 9551 00 07**. See page G15

■ *On request other colours available

GREY
F.....01**KEY ■**

The stacking containers marked with this symbol can be used to store foodstuffs.



Containers with this symbol are made of completely recyclable plastic material.



DIMENSIONS = 400x300 mm

SERIES STORAGE ATHENA

01

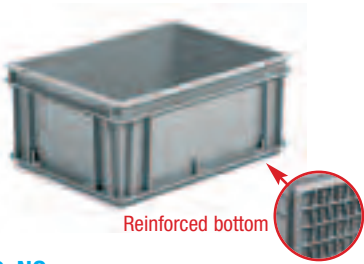

Reinforced bottom

ORD. NO.	DIM. mm
F PA 4551 AO 01	400x300x178 h
External dim. mm	400x300x178 h
Internal dim. mm	357x255x145 h
Capacity litres	15
Weight gr.	1485
Standard colour*	■
Bottom	reinforced
Long sides	closed
Short sides	closed
Lifting	bars
Label holder: ORD. NO. F PZ 0010 00 99 , ORD. NO. F PZ 9551 00 07 . See pag. G15	

01



ORD. NO.	DIM. mm
F PA 4851 AO 01	400x300x220 h
External dim. mm	400x300x220 h
Internal dim. mm	357x258x207 h
Capacity litres	20
Weight gr.	1230
Standard colour*	■
Bottom	solid
Long sides	closed
Short sides	closed
Lifting	bars
Label holder: ORD. NO. F PZ 0010 00 99 , ORD. NO. F PZ 9551 00 07 . See pag. G15	

01

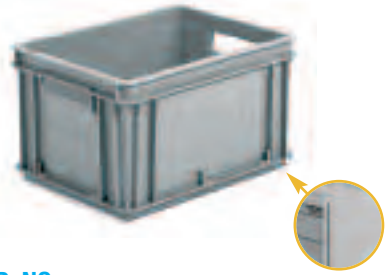

ORD. NO.	DIM. mm
F PA 4851 BO 01	400x300x220 h
External dim. mm	400x300x220 h
Internal dim. mm	357x258x206 h
Capacity litres	20
Weight gr.	1200
Standard colour*	■
Bottom	solid
Long sides	closed
Short sides	closed
Lifting	holes
Label holder: ORD. NO. F PZ 0010 00 99 , ORD. NO. F PZ 9551 00 07 . See pag. G15	

01

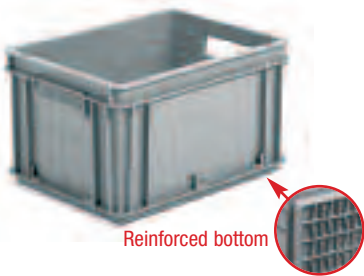

Reinforced bottom

ORD. NO.	DIM. mm
F PA 4951 BO 01	400x300x230 h
External dim. mm	400x300x230 h
Internal dim. mm	356x257x197 h
Capacity litres	20
Weight gr.	1390
Standard colour*	■
Bottom	reinforced
Long sides	closed
Short sides	closed
Lifting	holes
Label holder: ORD. NO. F PZ 0010 00 99 , ORD. NO. F PZ 9551 00 07 . See page G15	

01



ORD. NO.	DIM. mm
F PA 5251 AO 01	400x300x325 h
External dim. mm	400x300x325 h
Internal dim. mm	356x255x307 h
Capacity litres	30
Weight gr.	2050
Standard colour*	■
Bottom	solid
Long sides	closed
Short sides	closed
Lifting	bars
Label holder: ORD. NO. F PZ 0010 00 99 , ORD. NO. F PZ 9551 00 07 . See page G15	

01



ORD. NO.	DIM. mm
F PA 5251 BO 01	400x300x325 h
External dim. mm	400x300x325 h
Internal dim. mm	355x255x305 h
Capacity litres	30
Weight gr.	2020
Standard colour*	■
Bottom	solid
Long sides	closed
Short sides	closed
Lifting	holes
Label holder: ORD. NO. F PZ 0010 00 99 , ORD. NO. F PZ 9551 00 07 . See page G15	

*On request other colours available

Athena series stacking containers
ORD. NO. **F PA 6851 BO 01**



KEY



The stacking containers marked with this symbol can be used to store foodstuffs.



Containers with this symbol are made of completely recyclable plastic material.



GREY
F.....01

SERIES STORAGE ATHENA



ORD. NO. DIM. mm

F PA 5651 AO 01 600x400x76 h

External dim. mm 600x400x76 h

Internal dim. mm 555x353x58 h

Capacity litres 10

Weight gr. 1242

Standard colour* ■

Bottom **solid**

Long sides **closed**

Short sides **closed**

Lifting **bars**

Label holder: ORD. NO. **F PZ 0010 00 99**

See page G15



ORD. NO. DIM. mm

F PA 6051 AO 01 600x400x120 h

External dim. mm 600x400x120 h

Internal dim. mm 557x357x102 h

Capacity litres 20

Weight gr. 1585

Standard colour* ■

Bottom **solid**

Long sides **closed**

Short sides **closed**

Lifting **bars**

Label holder: ORD. NO. **F PZ 0010 00 99**

See page G15

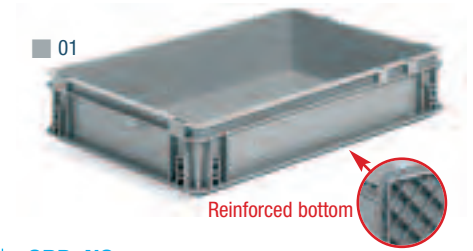

ORD. NO. DIM. mm

F PA 6151 AO 01 600x400x120 h

External dim. mm 600x400x120 h

Internal dim. mm 555x354x97 h

Capacity litres 20

Weight gr. 1685

Standard colour* ■

Bottom **reinforced**

Long sides **closed**

Short sides **closed**

Lifting **bars**

Label holder: ORD. NO. **F PZ 0010 00 99**

See page G15



ORD. NO. DIM. mm

F PA 6051 CO 01 600x400x120 h

External dim. mm 600x400x120 h

Internal dim. mm 557x356x102 h

Capacity litres 20

Weight gr. 1575

Standard colour* ■

Bottom **solid**

Long sides **perforated**

Short sides **closed**

Lifting **bars**

Label holder: ORD. NO. **F PZ 0010 00 99**

See page G15



ORD. NO. DIM. mm

F PA 6051 EO 01 600x400x120 h

External dim. mm 600x400x120 h

Internal dim. mm 557x357x103 h

Capacity litres 20

Weight gr. 1500

Standard colour* ■

Bottom **perforated**

Long sides **perforated**

Short sides **closed**

Lifting **bars**

Label holder: ORD. NO. **F PZ 0010 00 99**

See page G15



TROLLEY

ORD. NO. DIM. mm

F CP 2011 02 99 615x415x170/870 h

Trolley with 4 standard rubber swivel wheels
without brakes Ø 100 mm

Load capacity 150 kg

without stacking containers

■ *On request other colours available

■ For any further information: see page E8

GREY
F.....01

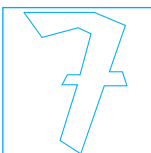

KEY ■



The stacking containers marked with this symbol can be used to store foodstuffs.



Containers with this symbol are made of completely recyclable plastic material.



DIMENSIONS = 600x400 mm

SERIES STORAGE ATHENA



ORD. NO.	DIM. mm
F PA 6451 AO 01	600x400x170 h
External dim. mm	600x400x170 h
Internal dim. mm	560x358x153 h
Capacity litres	30
Weight gr.	2125
Standard colour*	■
Bottom	solid
Long sides	closed
Short sides	closed
Lifting	bars

Label holder: ORD. NO. **F PZ 0010 00 99**,
ORD. NO. **F PZ 9751 00 07**. See page G15



ORD. NO.	DIM. mm
F PA 6551 AO 01	600x400x170 h
External dim. mm	600x400x170 h
Internal dim. mm	558x358x139 h
Capacity litres	30
Weight gr.	2330
Standard colour*	■
Bottom	reinforced
Long sides	closed
Short sides	closed
Lifting	bars

Label holder: ORD. NO. **F PZ 0010 00 99**,
ORD. NO. **F PZ 9751 00 07**. See page G15



ORD. NO.	DIM. mm
F PA 6851 AO 01	600x400x220 h
External dim. mm	600x400x220 h
Internal dim. mm	558x356x202 h
Capacity litres	40
Weight gr.	2620
Standard colour*	■
Bottom	solid
Long sides	closed
Short sides	closed
Lifting	holes

Label holder: ORD. NO. **F PZ 0010 00 99**,
ORD. NO. **F PZ 9751 00 07**. See page G15

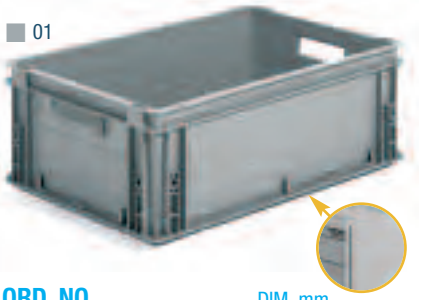

ORD. NO.	DIM. mm
F PA 6851 BO 01	600x400x220 h
External dim. mm	600x400x220 h
Internal dim. mm	558x357x202 h
Capacity litres	40
Weight gr.	2570
Standard colour*	■
Bottom	solid
Long sides	closed
Short sides	closed
Lifting	holes

Label holder: ORD. NO. **F PZ 0010 00 99**,
ORD. NO. **F PZ 9751 00 07**. See page G15



ORD. NO.	DIM. mm
F PA 6951 BO 01	600x400x220 h
External dim. mm	600x400x220 h
Internal dim. mm	560x358x188 h
Capacity litres	40
Weight gr.	2875
Standard colour*	■
Bottom	reinforced
Long sides	closed
Short sides	closed
Lifting	holes

Label holder: ORD. NO. **F PZ 0010 00 99**,
ORD. NO. **F PZ 9751 00 07**. See page G15

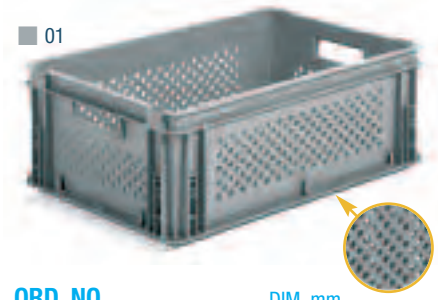

ORD. NO.	DIM. mm
F PA 6851 FO 01	600x400x220 h
External dim. mm	600x400x220 h
Internal dim. mm	557x356x202 h
Capacity litres	40
Weight gr.	2480
Standard colour*	■
Bottom	perforated
Long sides	perforated
Short sides	perforated
Lifting	holes

Label holder: ORD. NO. **F PZ 0010 00 99**,
ORD. NO. **F PZ 9751 00 07**. See page G15

*On request other colours available

TROLLEY

ORD. NO.
F CR 0441 00 04
Trolley with 2 polyurethane swivel wheels in rubber Ø 125 mm, 2 fixed wheels Ø 125 mm
Load capacity 300 kg
Only for lifting Athena and Odette series 600x400 mm

For any further information: see page G15



KEY



The stacking containers marked with this symbol can be used to store foodstuffs.



Containers with this symbol are made of completely recyclable plastic material.

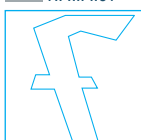

GREY
F.....01

SERIES STORAGE ATHENA



ORD. NO.	DIM. mm
F PA 7251 AO 01	600x400x285 h
External dim. mm	600x400x285 h
Internal dim. mm	557x356x263 h
Capacity litres	53
Weight gr.	2765
Standard colour*	■
Bottom	solid
Long sides	closed
Short sides	closed
Lifting	bars
Label holder: ORD. NO. F PZ 0010 00 99 , ORD. NO. F PZ 9751 00 07 . See page G15	

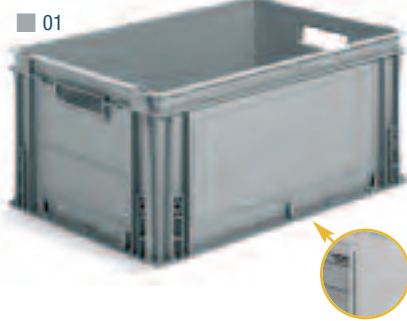

ORD. NO.	DIM. mm
F PA 7251 BO 01	600x400x285 h
External dim. mm	600x400x285 h
Internal dim. mm	557x357x263 h
Capacity litres	53
Weight gr.	2895
Standard colour*	■
Bottom	solid
Long sides	closed
Short sides	closed
Lifting	holes
Label holder: ORD. NO. F PZ 0010 00 99 , ORD. NO. F PZ 9751 00 07 . See page G15	

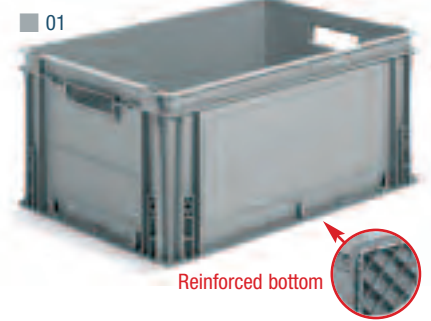

ORD. NO.	DIM. mm
F PA 7351 BO 01	600x400x285 h
External dim. mm	600x400x285 h
Internal dim. mm	557x357x256 h
Capacity litres	53
Weight gr.	3120
Standard colour*	■
Bottom	reinforced
Long sides	closed
Short sides	closed
Lifting	holes
Label holder: ORD. NO. F PZ 0010 00 99 , ORD. NO. F PZ 9751 00 07 . See page G15	



ORD. NO.	DIM. mm
F PA 7651 AO 01	600x400x325 h
External dim. mm	600x400x325 h
Internal dim. mm	558x358x308 h
Capacity litres	60
Weight gr.	3315
Standard colour*	■
Bottom	solid
Long sides	closed
Short sides	closed
Lifting	bars
Label holder: ORD. NO. F PZ 0010 00 99 , ORD. NO. F PZ 9751 00 07 . See page G15	



ORD. NO.	DIM. mm
F PA 7651 BO 01	600x400x325 h
External dim. mm	600x400x325 h
Internal dim. mm	558x357x308 h
Capacity litres	60
Weight gr.	3215
Standard colour*	■
Bottom	solid
Long sides	closed
Short sides	closed
Lifting	holes
Label holder: ORD. NO. F PZ 0010 00 99 , ORD. NO. F PZ 9751 00 07 . See page G15	

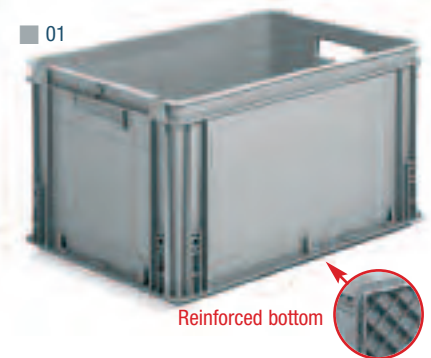

ORD. NO.	DIM. mm
F PA 7751 BO 01	600x400x325 h
External dim. mm	600x400x325 h
Internal dim. mm	558x358x295 h
Capacity litres	60
Weight gr.	3630
Standard colour*	■
Bottom	reinforced
Long sides	closed
Short sides	closed
Lifting	holes
Label holder: ORD. NO. F PZ 0010 00 99 , ORD. NO. F PZ 9751 00 07 . See page G15	

■ *On request other colours available

GREY
F.....01

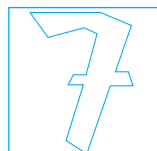

KEY ■



The stacking containers marked with this symbol can be used to store foodstuffs.



Containers with this symbol are made of completely recyclable plastic material.



DIMENSIONS = 600x400 mm

SERIES STORAGE ATHENA

01

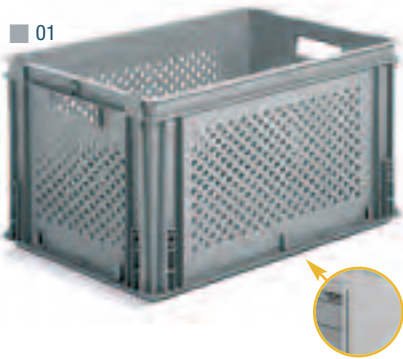

ORD. NO.	DIM. mm
F PA 7651 DO 01	600x400x325 h
External dim. mm	600x400x325 h
Internal dim. mm	558x358x308 h
Capacity litres	60
Weight gr.	3040
Standard colour*	■
Bottom	solid
Long sides	perforated
Short sides	perforated
Lifting	holes
Label holder: ORD. NO. F PZ 0010 00 99 , ORD. NO. F PZ 9751 00 07 . See page G15	

01

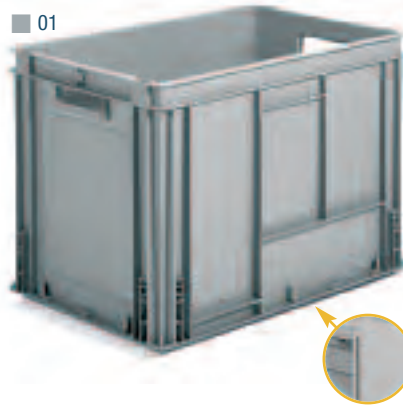

ORD. NO.	DIM. mm
F PA 8051 BO 01	600x400x430 h
External dim. mm	600x400x430 h
Internal dim. mm	557x356x415 h
Capacity litres	90
Weight gr.	3915
Standard colour*	■
Bottom	solid
Long sides	closed
Short sides	closed
Lifting	holes
Label holder: ORD. NO. F PZ 0010 00 99 , ORD. NO. F PZ 9751 00 07 . See page G15	

01

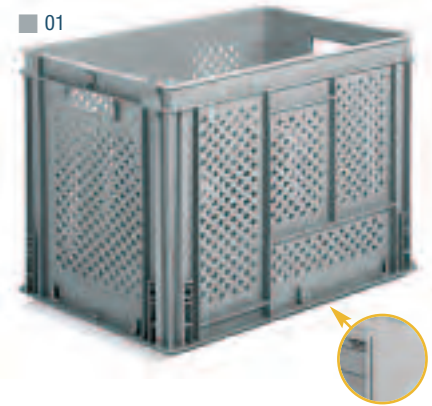

ORD. NO.	DIM. mm
F PA 8051 DO 01	600x400x430 h
External dim. mm	600x400x430 h
Internal dim. mm	557x357x415 h
Capacity litres	90
Weight gr.	3610
Standard colour*	■
Bottom	solid
Long sides	perforated
Short sides	perforated
Lifting	holes
Label holder: ORD. NO. F PZ 0010 00 99 , ORD. NO. F PZ 9751 00 07 . See page G15	

01



ORD. NO.	DIM. mm
F PA 8051 SO 01	600x400x430 h
External dim. mm	600x400x430 h
Internal dim. mm	557x357x415 h
Window dim. mm	462x180 h
Capacity litres	90
Weight gr.	3625
Standard colour*	■
Bottom	solid
Long sides	closed
Short sides	closed
Lifting	holes
Label holder: ORD. NO. F PZ 0010 00 99 , ORD. NO. F PZ 9751 00 07 . See page G15	

01



ORD. NO.	DIM. mm
F PA 8051 RO 01	600x400x430 h
External dim. mm	600x400x430 h
Internal dim. mm	557x357x415 h
Window dim. mm	260x183 h
Capacity litres	90
Weight gr.	3780
Standard colour*	■
Bottom	solid
Long sides	closed
Short sides	closed
Lifting	holes
Label holder: ORD. NO. F PZ 0010 00 99 , ORD. NO. F PZ 9751 00 07 . See page G15	

*On request other colours available

KEY



The stacking containers marked with this symbol can be used to store foodstuffs.



Containers with this symbol are made of completely recyclable plastic material.



GREY
F.....01

SERIES STORAGE ATHENA

■ 01

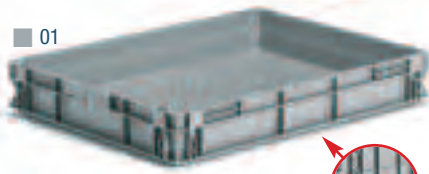

Reinforced bottom

**ORD. NO.**

DIM. mm

F PA 8551 AO 01 800x600x120 h

External dim. mm 800x600x120 h

Internal dim. mm 757x557x86 h

Capacity litres 49

Weight gr. 3450

Standard colour* ■

Bottom **reinforced**Long sides **closed**Short sides **closed**Lifting **bars**Label holder: ORD. NO. **F PZ 0010 00 99**

See page G15

■ 01



Reinforced bottom

**ORD. NO.**

DIM. mm

F PA 8751 AO 01 800x600x170 h

External dim. mm 800x600x170 h

Internal dim. mm 758x555x137 h

Capacity litres 69

Weight gr. 3920

Standard colour* ■

Bottom **reinforced**Long sides **closed**Short sides **closed**Lifting **bars**Label holder: ORD. NO. **F PZ 0010 00 99**,ORD. NO. **F PZ 9751 00 07**. See page G15

■ 01



Reinforced bottom

**ORD. NO.**

DIM. mm

F PA 8951 AO 01 800x600x220 h

External dim. mm 800x600x220 h

Internal dim. mm 757x556x188 h

Capacity litres 90

Weight gr. 4630

Standard colour* ■

Bottom **reinforced**Long sides **closed**Short sides **closed**Lifting **bars**Label holder: ORD. NO. **F PZ 0010 00 99**,ORD. NO. **F PZ 9751 00 07**. See page G15

■ 01



Reinforced bottom

**ORD. NO.**

DIM. mm

F PA 9351 AO 01 800x600x325 h

External dim. mm 800x600x325 h

Internal dim. mm 756x555x294 h

Capacity litres 130

Weight gr. 5270

Standard colour* ■

Bottom **reinforced**Long sides **closed**Short sides **closed**Lifting **bars**Label holder: ORD. NO. **F PZ 0010 00 99**,ORD. NO. **F PZ 9751 00 07**. See page G15

■ 01



Reinforced bottom

**ORD. NO.**

DIM. mm

F PA 9751 AO 01 800x600x430 h

External dim. mm 800x600x430 h

Internal dim. mm 756x555x395 h

Capacity litres 175

Weight gr. 6200

Standard colour* ■

Bottom **reinforced**Long sides **closed**Short sides **closed**Lifting **bars**Label holder: ORD. NO. **F PZ 0010 00 99**,ORD. NO. **F PZ 9751 00 07**. See page G15

■ Detail of stacking containers with reinforced bottom 800x600 mm

■ *On request other colours available

GREY
F.....01

**KEY**

The stacking containers marked with this symbol can be used to store foodstuffs.



Containers with this symbol are made of completely recyclable plastic material.



DIMENSIONS = 800x600 mm

SERIES STORAGE ATHENA

CONTAINER INCLUDING 1 SET OF FOUR FEET

- Supplied assembled

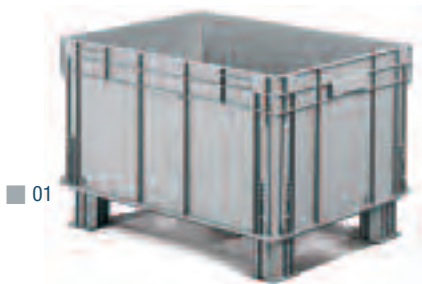

ORD. NO.	DIM. mm
F PA 8551 AD 01	800x600x220 h
With 120 mm high container	
Capacity litres	49
F PA 8751 AD 01	800x600x270 h
With 170 mm high container	
Capacity litres	69
F PA 8951 AD 01	800x600x320 h
With 220 mm high container	
Capacity litres	90
F PA 9351 AD 01	800x600x425 h
With 325 mm high container	
Capacity litres	130
F PA 9751 AD 01	800x600x530 h
With 430 mm high container	
Capacity litres	175

CONTAINER INCLUDING 1 SET OF FOUR FEET AND 1 PAIR OF CONNECTION PIECES

- Supplied assembled

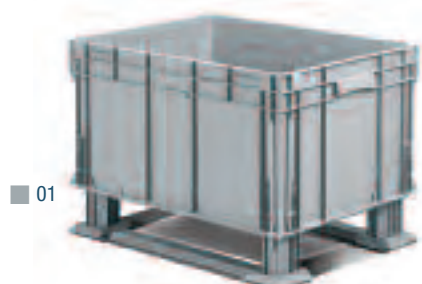

ORD. NO.	DIM. mm
F PA 8551 AE 01	800x600x245 h
With 120 mm high container	
Capacity litres	49
F PA 8751 AE 01	800x600x295 h
With 170 mm high container	
Capacity litres	69
F PA 8951 AE 01	800x600x345 h
With 220 mm high container	
Capacity litres	90
F PA 9351 AE 01	800x600x450 h
With 325 mm high container	
Capacity litres	130
F PA 9751 AE 01	800x600x555 h
With 430 mm high container	
Capacity litres	175

CONTAINER INCLUDING 1 SET OF FOUR Ø 100 mm RUBBER SWIVEL WHEELS

- Supplied assembled



ORD. NO.	DIM. mm
F PA 8551 AF 01	800x600x245 h
With 120 mm high container	
Capacity litres	49
F PA 8751 AF 01	800x600x295 h
With 170 mm high container	
Capacity litres	69
F PA 8951 AF 01	800x600x345 h
With 220 mm high container	
Capacity litres	90
F PA 9351 AF 01	800x600x450 h
With 325 mm high container	
Capacity litres	130
F PA 9751 AF 01	800x600x555 h
With 430 mm high container	
Capacity litres	175



- The containers can be stacked thanks to the 4 feet which enter inside the container below



- The 2 connection pieces allow the containers to be stacked



- The containers can be stacked thanks to the 4 wheels which enter inside the container below

■ KEY



The stacking containers marked with this symbol can be used to store foodstuffs.



Containers with this symbol are made of completely recyclable plastic material.



GREY
F.....01

SERIES STORAGE ATHENA

HINGED LID SERIES F PA 300x200 / 400x300 / 600x400



Hinged lid

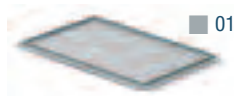

01

ORD. NO.

F PA 0351 00 01

Hinged lid mm

300x200

Weight gr. 155

Standard colour* ■

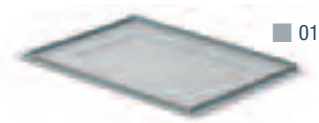

01

ORD. NO.

F PA 0651 00 01

Hinged lid mm

400x300

Weight gr. 320

Standard colour* ■



01

ORD. NO.

F PA 0951 00 01

Hinged lid mm

600x400

Weight gr. 722

Standard colour* ■

COVER SERIES F PA 400x300 / 600x400 / 800x600



Cover



01

ORD. NO.

F PA 1B51 00 01

Lid mm

400x300

Weight gr. 375

Standard colour* ■

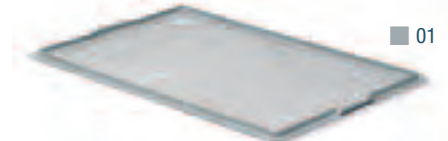

01

ORD. NO.

F PA 1C51 00 01

Lid mm

600x400

Weight gr. 750

Standard colour* ■



01

ORD. NO.

F PA 1251 01 01

Lid mm

800x600

Weight gr. 1685

Standard colour* ■

For containers ORD. NO. F PA 8551 A0 01

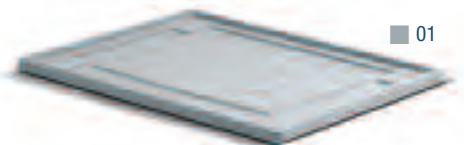

01

ORD. NO.

F PA 1251 00 01

Lid mm

800x600

Weight gr. 1710

Standard colour* ■

For containers ORD. NO. F PA 8751 A0 01, F PA 8951 A0 01, F PA 9351 A0 01, F PA 9751 A0 01

■ *On request other colours available

SLIDING LID SERIES F PA 400x300



Sliding lid

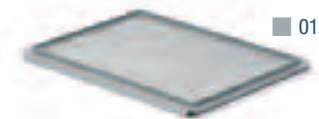

01

ORD. NO.

F PA 1651 00 01

Sliding lid mm

400x300

Weight gr. 440

Standard colour* ■

■ Not suitable for ORD. NO. F PA 3251 A0 01

ORD. NO. F PZ 0681 00 13

Pair of sliding hooks suitable for Athena series containers with the following heights: 50/120/170/220/320/430 mm.

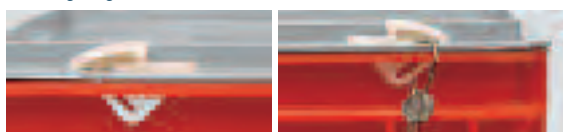

■ Kick-in locks not suitable for stacking containers
ORD. NO. F PA 5651 A0 ..

GREY
F.....01

KEY ■



The stacking containers marked with this symbol can be used to store foodstuffs.

Containers with this symbol are made of completely recyclable plastic material.



DIMENSIONS = 400x300 / 600x400 mm

SERIES STORAGE ATHENA

SUB-DIVIDING CONTAINERS FOR SERIES ATHENA 400x300

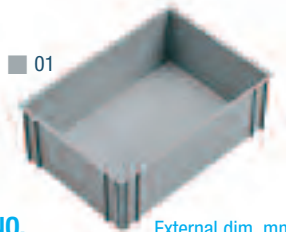

01

ORD. NO. External dim. mm

F PP 4051 00 01 250x176x90 h

Standard colour

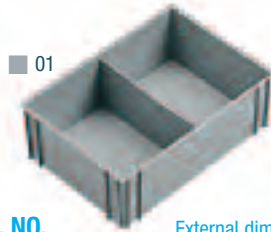

01

ORD. NO. External dim. mm

F PP 4551 00 01 256x176x90 h

Standard colour

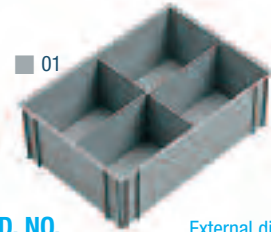

01

ORD. NO. External dim. mm

F PP 5051 00 01 256x176x90 h

Standard colour

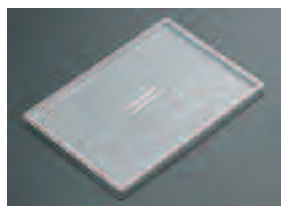

96



ORD. NO. External dim. mm

F PP 9368 00 96 252x178

Colour transparent

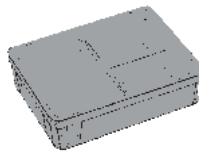

STACKING CONTAINER
DIVIDED WITH

1 ORD. NO. F PP 4051 00 01
1 ORD. NO. F PP 4551 00 01

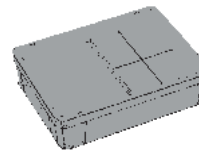

STACKING CONTAINER
DIVIDED WITH

1 ORD. NO. F PP 4051 00 01
1 ORD. NO. F PP 5051 00 01

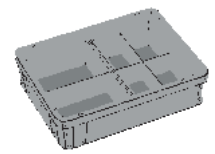

STACKING CONTAINER
DIVIDED WITH

1 ORD. NO. F PP 4551 00 01
1 ORD. NO. F PP 5051 00 01

SUB-DIVIDING CONTAINERS FOR SERIES ATHENA - THEMA 600x400

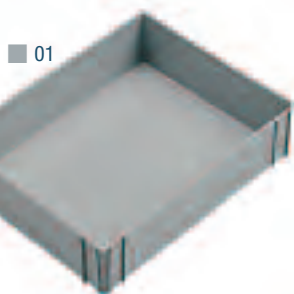

01

ORD. NO. External dim. mm

F PP 6051 00 01 358x278x90 h

Standard colour

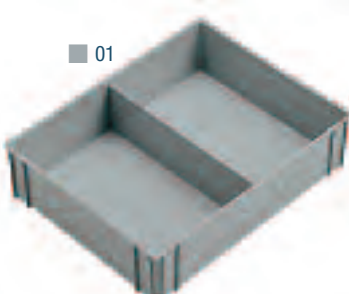

01

ORD. NO. External dim. mm

F PP 6551 00 01 358x278x90 h

Standard colour

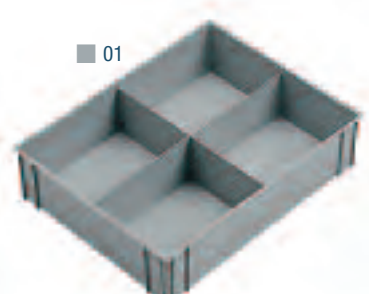

01

ORD. NO. External dim. mm

F PP 7051 00 01 358x278x90 h

Standard colour



96



ORD. NO. External dim. mm

F PP 9668 00 96 358x278

Colour transparent

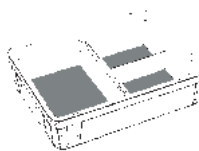

STACKING CONTAINER
DIVIDED WITH

1 ORD. NO. F PP 6051 00 01
1 ORD. NO. F PP 6551 00 01

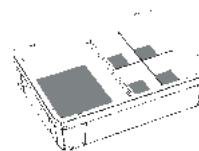

STACKING CONTAINER
DIVIDED WITH

1 ORD. NO. F PP 6051 00 01
1 ORD. NO. F PP 7051 00 01

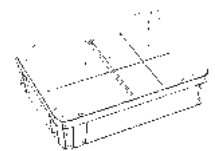

STACKING CONTAINER
DIVIDED WITH

1 ORD. NO. F PP 6551 00 01
1 ORD. NO. F PP 7051 00 01

KEY



Containers with this symbol are made of completely recyclable plastic material.



TRANSPARENT
F. 99

GREY
F. 01



SERIES STORAGE ATHENA

SLOTTED PARTITIONS FOR STACKING CONTAINERS SERIES
ATHENA - THEMA

HEIGHT mm 45 h



ORD. NO.	DIM mm	increments mm	for containers series
F HN 1320 00 01	255x45	20	400x300
F HN 1420 00 01	355x45	20	400x300 / 600x400
F HN 1620 00 01	555x45	20	600x400



HEIGHT mm 70 h

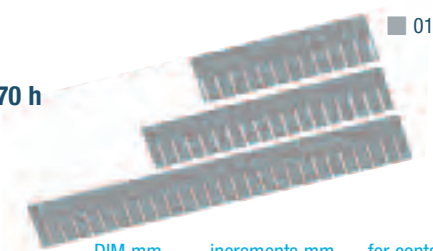

ORD. NO.	DIM mm	increments mm	for containers series
F HN 1340 00 01	255x70	20	400x300
F HN 1440 00 01	355x70	20	400x300 / 600x400
F HN 1640 00 01	555x70	20	600x400

HEIGHT mm 90 h

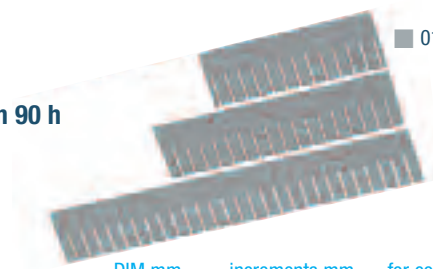

ORD. NO.	DIM mm	increments mm	for containers series
F HN 1350 00 01	255x90	20	400x300
F HN 1450 00 01	355x90	20	400x300 / 600x400
F HN 1650 00 01	555x90	20	600x400

HEIGHT mm 120 h

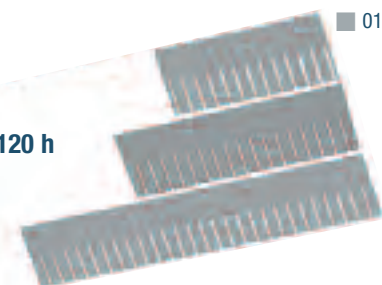

ORD. NO.	DIM mm	increments mm	for containers series
F HN 1360 00 01	255x120	20	400x300
F HN 1460 00 01	355x120	20	400x300 / 600x400
F HN 1660 00 01	555x120	20	600x400

HEIGHT mm 180 h

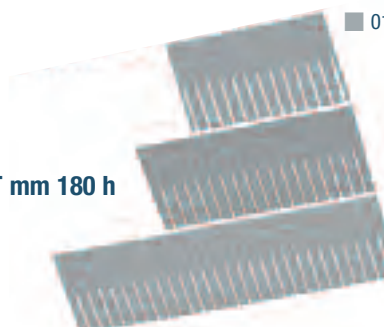

ORD. NO.	DIM mm	increments mm	for containers series
F HN 1370 00 01	255x180	20	400x300
F HN 1470 00 01	355x180	20	400x300 / 600x400
F HN 1670 00 01	555x180	20	600x400

COVER OR LAYER SEPARATOR

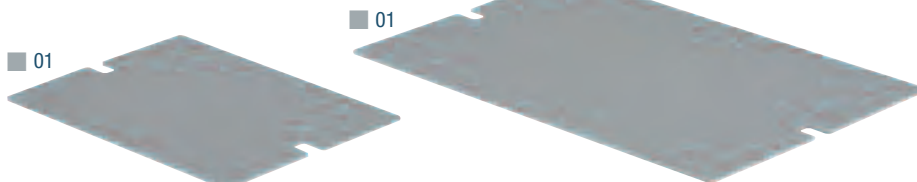

ORD. NO.	DIM. mm
F HN 5130 00 01	355x255
For containers Athena-Thema	400x300
Standard colour ■	

ORD. NO.	DIM. mm
F HN 5140 00 01	555x355
For containers Athena-Thema	600x400
Standard colour ■	

■ example of use as a cover or layer separator

GREY
F.....01

INFO ■



www.famispa.com

LABEL HOLDER FOR ATHENA AND NETTUNO SERIES 400x300

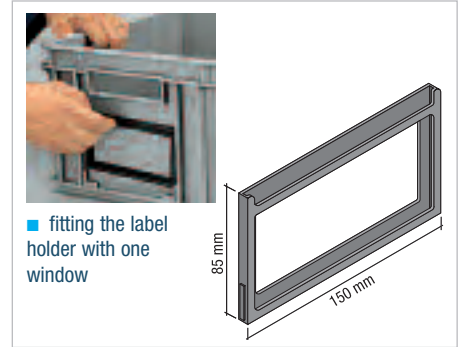

ORD. NO.	External dim. mm
F PZ 9551 00 07	150x85
Standard colour ■	

LABEL	External dim. mm
ORD. NO. F PZ 0920 00 00	145x81
Quantity per sheet: 4	



LABEL HOLDER FOR ATHENA AND NETTUNO SERIES 600x400



ORD. NO.	External dim. mm
F PZ 9751 00 07	215x85
Standard colour ■	

LABEL	External dim. mm
ORD. NO. F PZ 0940 00 00	210x81
Quantity per sheet: 3	

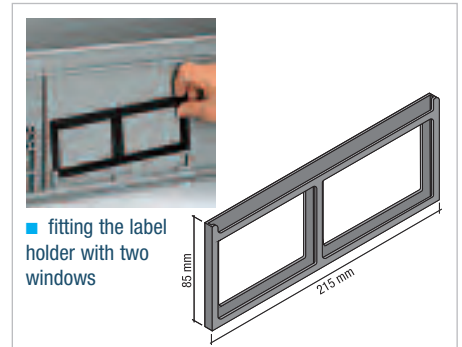

METAL CLIPS FOR ATHENA - THEMA - MINERVA SERIES



ORD. NO. F PZ 0010 00 99

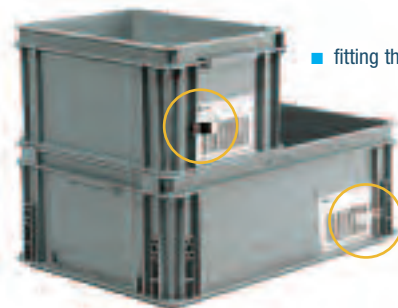

TROLLEYS FOR LIFTING AND TRANSPORTING STORAGE AND STACKING CONTAINERS SERIES ATHENA - ODETTE 600x400 mm

ORD. NO.	LOAD CAPACITY kg
F CR 0441 00 04	300
Only for lifting series Athena and Odette 600x400 mm	
2 swivel wheels in rubber Ø 125 mm	
2 fixed wheels in polyurethane Ø 125 mm	

■ 04



■ Only for lifting series Athena and Odette 600x400 mm

transport system

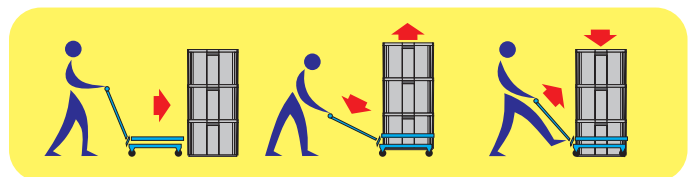

■ INFO



www.famispa.com

■ RAL 5012 F.04

■ GALVANISED F.99

■ BLACK F.07



SERIES STORAGE ODETTTE KLT

- GOOD RESISTANCE TO OILS
- DIFFERENT AUTOMATED HANDLING OPTIONS
- STRONG ERGONOMICS HANDLES
- EXCELLENT LEVEL OF SAFETY AND RESISTANCE
- SMOOTH BOTTOM FOR NOISELESS MOVEMENT ON CONVEYORS
- PERFORATED BOTTOM FOR WATER DRAINAGE



BLUE
F.27

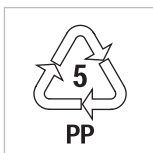
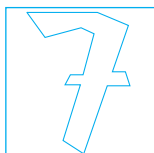

KEY ■



Containers with this symbol are made of completely recyclable plastic material.



DIMENSIONS = 600x400 / 400x300 / 300x200 mm

SERIES STORAGE ODETTE KLT

■ 27



NEW

ORD. NO.	DIM. mm
F PC 7251 00 27	600x400x280 h
External dim. mm	600x400x280 h
Internal dim. mm	544x359x262 h
Capacity litres	51,9
Weight gr.	2670
Standard colour	■

ORD. NO.	DIM. mm
F PC 6651 00 27	600x400x147,5 h
External dim. mm	600x400x147,5 h
Internal dim. mm	544x359x129,5 h
Capacity litres	25,3
Weight gr.	1900
Standard colour	■

■ 27



NEW

ORD. NO.	DIM. mm
F PC 5051 00 27	400x300x280 h
External dim. mm	400x300x280 h
Internal dim. mm	346x260x262 h
Capacity litres	24,1
Weight gr.	1700
Standard colour	■

ORD. NO.	DIM. mm
F PC 4251 00 27	400x300x147,5 h
External dim. mm	400x300x147,5 h
Internal dim. mm	346x260x129,5 h
Capacity litres	13,1
Weight gr.	1080
Standard colour	■

ORD. NO.	DIM. mm
F PC 2351 00 27	300x200x147,5 h
External dim. mm	300x200x147,4 h
Internal dim. mm	243x162x129,7 h
Capacity litres	5,3
Weight gr.	570
Standard colour	■

■ KEY



Containers with this symbol are made of completely recyclable plastic material.



■ BLUE
F.....27

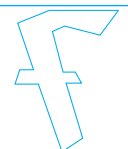

SERIES STORAGE ODETTE

- FOR AUTOMATIC HANDLING
- OIL RESISTANT
- FOR STORAGE SYSTEM
- FOR MANUAL HANDLING

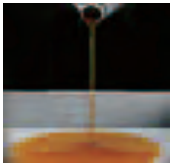
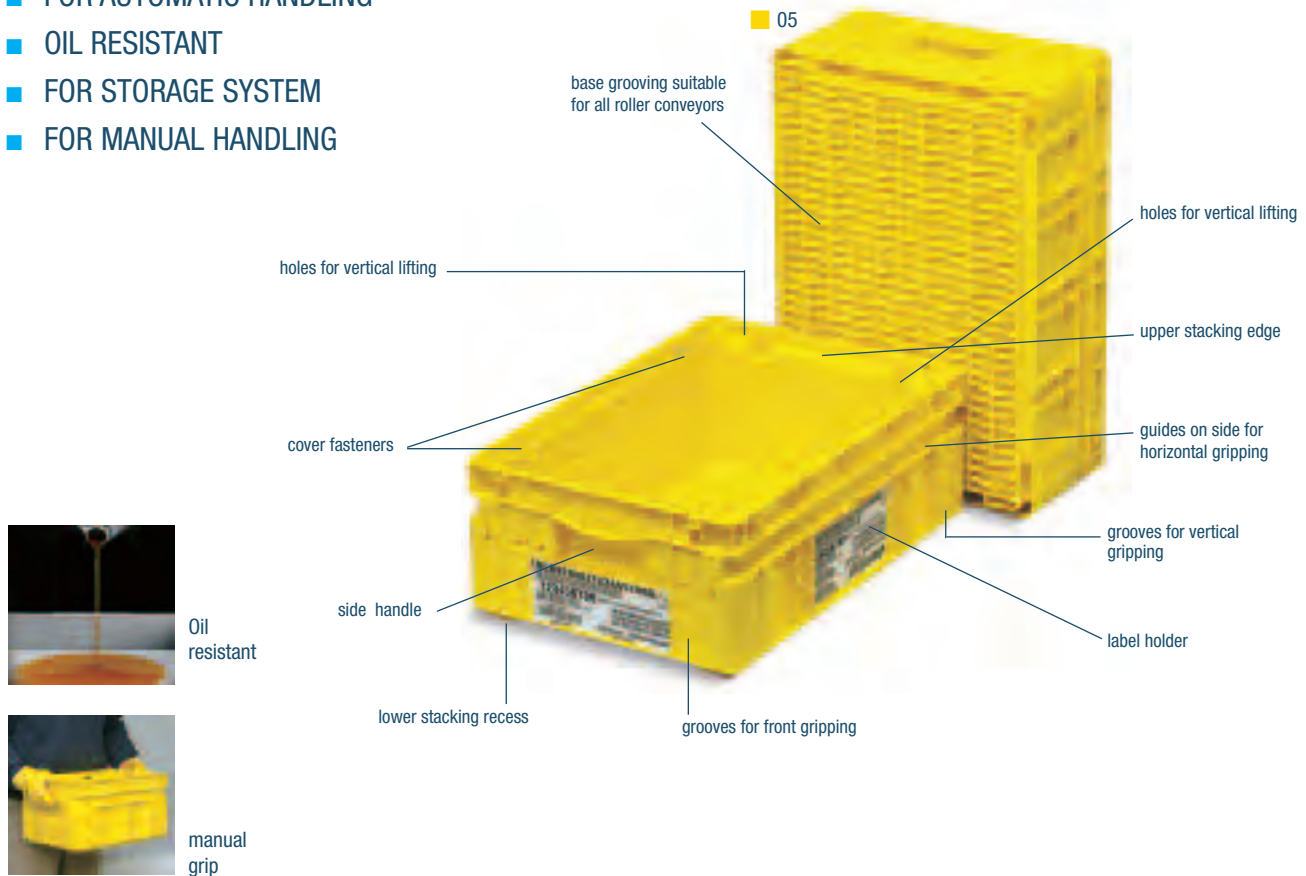

Oil resistant



manual grip



FAMI is the only Italian company to produce containers approved by the "Odette" European commission. They have the following features:

- 8 different automatic handling systems;
- tough ergonomic handles;
- good ratio between external volume and useful volume;
- reinforced and structured bottom for easy sliding along all kinds of roller conveyors;
- 2 label holders for A5 "bar code" labels in "Odette" standard;
- high level of safety (coefficient 3 measured in various crash tests).

PLASTIC PALLETS FOR ODETTE STACKING CONTAINERS

Plastic pallet for **Odette** containers with galvanised steel edges on all 4 sides

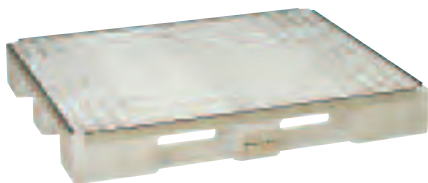

ORD. NO.	EXTERNAL DIM. mm
F PU 2140 00 13	1200x800x150 h
Load capacity on floor kg 4000	
Load capacity on fork lift truck kg 1500	
Weight kg	14,50

ORD. NO.	EXTERNAL DIM. mm
F PU 3140 00 13	1200x1000x150 h
Load capacity on floor kg 4000	
Load capacity on fork lift truck kg 1500	
Weight kg	17,60

YELLOW
F. 05

GALVANISED F. 99

KEY ■



Containers with this symbol are made of completely recyclable plastic material.

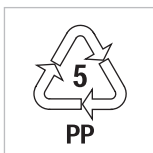
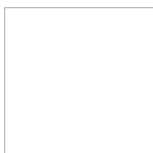
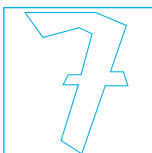

DIMENSIONS: 300x200 / 400x200 / 600x400 mm

SERIES STORAGE ODETTE

ODETTE SERIES STACKING CONTAINERS
F PC 300x200 / 400x300 / 600x400



05



ORD. NO.	DIM. mm
F PC 2451 00 05	300x200x147,5 h
External dim. mm	300x200x147,5 h
Internal dim. mm	234x158x126 h
Capacity litres	4,6
Weight gr.	610
Standard colour*	■
Bottom	solid
Long sides	closed
Short sides	closed
Lifting	bars

05



ORD. NO.	DIM. mm
F PC 4851 00 05	400x300x220 h
External dim. mm	400x300x220 h
Internal dim. mm	336x262x187 h
Capacity litres	15,8
Weight gr.	1820
Standard colour*	■
Bottom	solid
Long sides	closed
Short sides	closed
Lifting	bars



05



ORD. NO.	DIM. mm
F PC 6851 00 05	600x400x220 h
External dim. mm	600x400x220 h
Internal dim. mm	535x361x185 h
Capacity litres	34,8
Weight gr.	2880
Standard colour*	■
Bottom	solid
Long sides	closed
Short sides	closed
Lifting	bars

05



ORD. NO.	DIM. mm
F PC 7651 00 05	600x400x320 h
External dim. mm	600x400x320 h
Internal dim. mm	536x361x282 h
Capacity litres	53
Weight gr.	3905
Standard colour*	■
Bottom	solid
Long sides	closed
Short sides	closed
Lifting	bars

LID FOR ODETTE SERIES STACKING CONTAINERS F PC

05



ORD. NO.	DIM. mm
F PC 0351 00 05	300x200
Weight gr.	106
Standard colour*	■

05



ORD. NO.	DIM. mm
F PC 0651 00 05	400x300
Weight gr.	240
Standard colour*	■

05



ORD. NO.	DIM. mm
F PC 0951 00 05	600x400
Weight gr.	500
Standard colour*	■

■ KEY

■ YELLOW
F.....05



Containers with this symbol are made of completely recyclable plastic material.

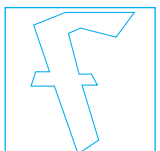

SERIES STORAGE ODETTTE

■ 05



NEW

Label holder for label dim.
210x105 mm h

ORD. NO.

DIM. mm

F PC 9651 00 05 **1000x400x232 h**

External dim. mm 1000x400x232 h

Internal dim. mm 935x355x197 h

Capacity litres 65

Weight gr. 3500

Standard colour* ■

Bottom **solid**Long sides **closed**Short sides **closed**Lifting **bars**■ Detail of stacking containers with reinforced bottom
ORD. NO. F PC 9651 00 05

■ *On request other colours available

YELLOW
F. 05

KEY ■

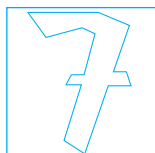

Containers with this symbol are made of completely recyclable plastic material.



- GOOD COMPARISON BETWEEN QUALITY AND PRICE
- SUITABLE FOR STORE FOODSTUFFS
- LIGHT IN WEIGHT



Oil resistant



The stacking containers marked with this symbol can be used to store foodstuffs



Strong and resistant to high and low temperatures



■ 01

THEMA CONTAINERS SERIES F PA 600x400

■ *On request other colours available

■ 01



ORD. NO.	DIM. mm
F PB 6851 AO 01	600x400x220 h
External dim. mm	600x400x220 h
Internal dim. mm	555x355x203 h
Capacity litres	40
Weight gr.	1960
Standard colour*	■
Bottom	solid
Long sides	closed
Short sides	closed
Lifting	bars

Label holder: ORD. NO. **F PZ 0010 00 99**
See page G15

■ 01



ORD. NO.	DIM. mm
F PB 6851 BO 01	600x400x220 h
External dim. mm	600x400x220 h
Internal dim. mm	555x354x203 h
Capacity litres	40
Weight gr.	1950
Standard colour*	■
Bottom	solid
Long sides	closed
Short sides	closed
Lifting	holes

Label holder: ORD. NO. **F PZ 0010 00 99**
See page G15

■ 01

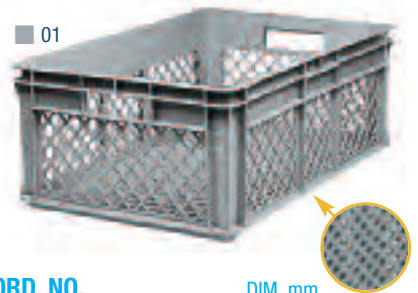

ORD. NO.	DIM. mm
F PB 6851 FO 01	600x400x220 h
External dim. mm	600x400x220 h
Internal dim. mm	556x356x200 h
Capacity litres	40
Weight gr.	1475
Standard colour*	■
Bottom	perforated
Long sides	perforated
Short sides	perforated
Lifting	holes

Label holder: ORD. NO. **F PZ 0010 00 99**
See page G15

■ KEY



The stacking containers marked with this symbol can be used to store foodstuffs.



Containers with this symbol are made of completely recyclable plastic material.

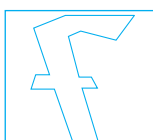

■ GREY
F.....01

SERIES STORAGE MINERVA

- MAXIMUM VOLUME REDUCTION BY EMPTY CONTAINERS
- IDEAL FOR TRANSPORT ON TRUCK DELIVERIES
- GOOD COMPARISON BETWEEN QUALITY AND PRICE



Oil resistant



The stacking containers marked with this symbol can be used to store foodstuffs



Strong and resistant to high and low temperatures



01



The Minerva series stacking containers respect the unified european dimensions 600x400 mm and can be therefore perfectly palletized.



TROLLEYS FOR LIFTING AND TRANSPORTING STACKING CONTAINERS SERIES MINERVA 600x400 mm

ORD. NO.	LOAD CAPACITY kg
F CR 0461 00 04	300
Only for lifting series Minerva	
2 rubber swivel wheels Ø 125 mm	
2 polyurethane fixed wheels Ø 125 mm	



■ how to use the lifting trolley



04



GREY F.01

RAL 5012 F.04

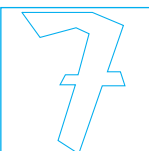

KEY ■



The stacking containers marked with this symbol can be used to store foodstuffs.



Containers with this symbol are made of completely recyclable plastic material.



DIMENSIONS = 600x400

SERIES STORAGE MINERVA

STACKING CONTAINERS SERIES F PE 600x400

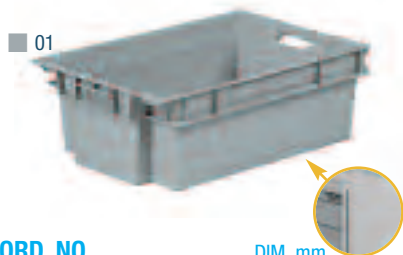

ORD. NO.	DIM. mm
F PE 6851 BO 01	600x400x200 h
External dim. mm	600x400x200 h
Internal dim. mm	455x338x180 h
Capacity litres	32
Weight gr.	1750
Standard colour*	■
Bottom	solid
Long sides	closed
Short sides	closed
Lifting	holes
Label holder: ORD. NO. F PZ 0010 00 99	
See page G15	

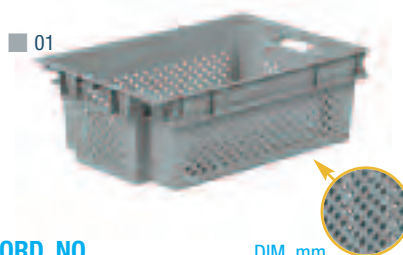

ORD. NO.	DIM. mm
F PE 6851 FO 01	600x400x200 h
External dim. mm	600x400x200 h
Internal dim. mm	458x338x177 h
Capacity litres	32
Weight gr.	1520
Standard colour*	■
Bottom	perforated
Long sides	perforated
Short sides	perforated
Lifting	holes
Label holder: ORD. NO. F PZ 0010 00 99	
See page G15	



ORD. NO.	DIM. mm
F PE 7651 BO 01	600x400x300 h
External dim. mm	600x400x300 h
Internal dim. mm	455x338x272 h
Capacity litres	50
Weight gr.	2500
Standard colour*	■
Bottom	solid
Long sides	closed
Short sides	closed
Lifting	holes
Label holder: ORD. NO. F PZ 0010 00 99	
See page G15	

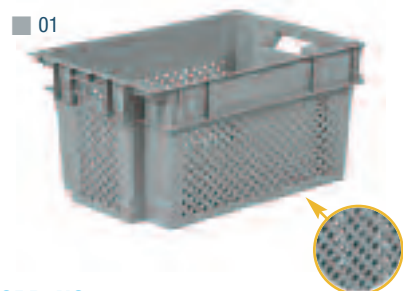

ORD. NO.	DIM. mm
F PE 7651 FO 01	600x400x300 h
External dim. mm	600x400x300 h
Internal dim. mm	455x337x270 h
Capacity litres	50
Weight gr.	2320
Standard colour*	■
Bottom	perforated
Long sides	perforated
Short sides	perforated
Lifting	holes
Label holder: ORD. NO. F PZ 0010 00 99	
See page G15	



ORD. NO.	DIM. mm
F PE 8051 BO 01	600x400x400 h
External dim. mm	600x400x400 h
Internal dim. mm	453x337x370 h
Capacity litres	70
Weight gr.	2940
Standard colour*	■
Bottom	solid
Long sides	closed
Short sides	closed
Lifting	holes
Label holder: ORD. NO. F PZ 0010 00 99	
See page G15	



ORD. NO.	DIM. mm
F PE 8051 FO 01	600x400x400 h
External dim. mm	600x400x400 h
Internal dim. mm	455x337x372 h
Capacity litres	70
Weight gr.	2865
Standard colour*	■
Bottom	perforated
Long sides	perforated
Short sides	perforated
Lifting	holes
Label holder: ORD. NO. F PZ 0010 00 99	
See page G15	

SNAP SPRING FOR LID CLOSING



ORD. NO. **F PZ 0020 00 99** ■ 99

LID SERIES F PE 600x400

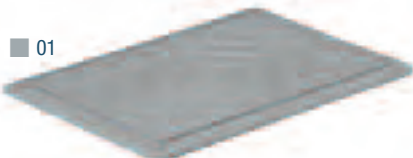

ORD. NO.	DIM. mm
F PE 0951 00 01	600x400
Weight gr.	960
Standard colour*	■

■ *On request other colours available

KEY



The stacking containers marked with this symbol can be used to store foodstuffs.



Containers with this symbol are made of completely recyclable plastic material.



GREY
F.....01

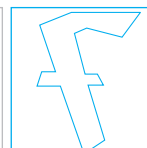

SERIES STORAGE DELTA

- MAXIMUM VOLUME REDUCTION BY EMPTY CONTAINERS
- IDEAL FOR TRANSPORT ON TRUCK DELIVERIES
- STACKABLE USING THE SUPPORT



- the flush handles offer a safe and easy grip even for gloved hand

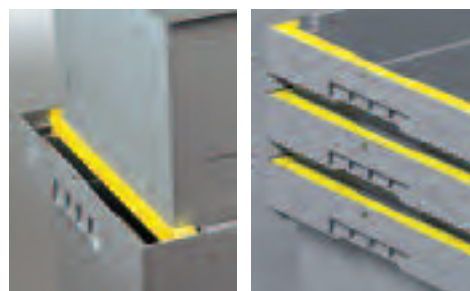

- example of stacking full containers with opened supports and with closed supports



- the lid can be fastened with a security seal



- The support (**pic. 1**) is pushed to its stop (**pic. 2**) and is blocked by pressing downwards (**pic. 3**).



GREY
F.....01

KEY ■



The stacking containers marked with this symbol can be used to store foodstuffs.



Containers with this symbol are made of completely recyclable plastic material.

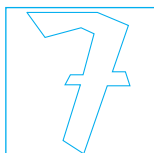

DIMENSIONS = 600x400

SERIES STORAGE DELTA

STACKING CONTAINERS SERIES F PD 600x400

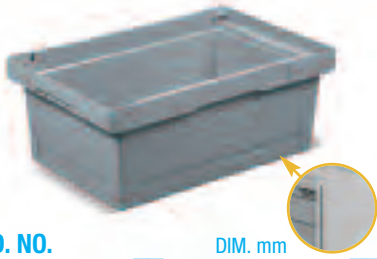

ORD. NO.	DIM. mm
F PD 6851 AO 01	600x400x225 h
External dim. mm	600x400x225 h
Internal dim. mm	499x329x195 h
Capacity litres	38
Weight gr.	1742
Standard colour*	■
Bottom	solid
Long sides	closed
Short sides	closed
Lifting	bars



ORD. NO.	DIM. mm
F PD 7651 AO 01	600x400x325 h
External dim. mm	600x400x325 h
Internal dim. mm	499x329x295 h
Capacity litres	58
Weight gr.	2332
Standard colour*	■
Bottom	solid
Long sides	closed
Short sides	closed
Lifting	bars



ORD. NO.	DIM. mm
F PD 8051 AO 01	600x400x425 h
External dim. mm	600x400x425 h
Internal dim. mm	499x329x395 h
Capacity litres	74
Weight gr.	2858
Standard colour*	■
Bottom	solid
Long sides	closed
Short sides	closed
Lifting	bars



ORD. NO.	DIM. mm
F PD 6851 AB 01	600x400x230 h
External dim. mm	600x400x230 h
Internal dim. mm	499x329x195 h
Capacity litres	38
Weight gr.	1930
Standard colour*	■
Bottom	solid
Long sides	closed
Short sides	closed
Lifting	bars

Complete with supports for stacking



ORD. NO.	DIM. mm
F PD 7651 AB 01	600x400x330 h
External dim. mm	600x400x330 h
Internal dim. mm	499x329x295 h
Capacity litres	58
Weight gr.	2524
Standard colour*	■
Bottom	solid
Long sides	closed
Short sides	closed
Lifting	bars

Complete with supports for stacking



ORD. NO.	DIM. mm
F PD 8051 AB 01	600x400x430 h
External dim. mm	600x400x430 h
Internal dim. mm	499x329x395 h
Capacity litres	74
Weight gr.	3055
Standard colour*	■
Bottom	solid
Long sides	closed
Short sides	closed
Lifting	bars

Complete with supports for stacking



ORD. NO.	DIM. mm
F PD 6851 AA 01	610x400x240 h
External dim. mm	610x400x240 h
Internal dim. mm	499x329x195 h
Capacity litres	38
Weight gr.	2640
Standard colour*	■
Bottom	solid
Long sides	closed
Short sides	closed
Lifting	bars

Complete with hinged lid



ORD. NO.	DIM. mm
F PD 7651 AA 01	610x400x340 h
External dim. mm	610x400x340 h
Internal dim. mm	499x329x295 h
Capacity litres	58
Weight gr.	3230
Standard colour*	■
Bottom	solid
Long sides	closed
Short sides	closed
Lifting	bars

Complete with hinged lid



ORD. NO.	DIM. mm
F PD 8051 AA 01	610x400x440 h
External dim. mm	610x400x440 h
Internal dim. mm	499x329x395 h
Capacity litres	74
Weight gr.	3765
Standard colour*	■
Bottom	solid
Long sides	closed
Short sides	closed
Lifting	bars

Complete with hinged lid

SERIES STORAGE NETTUNO

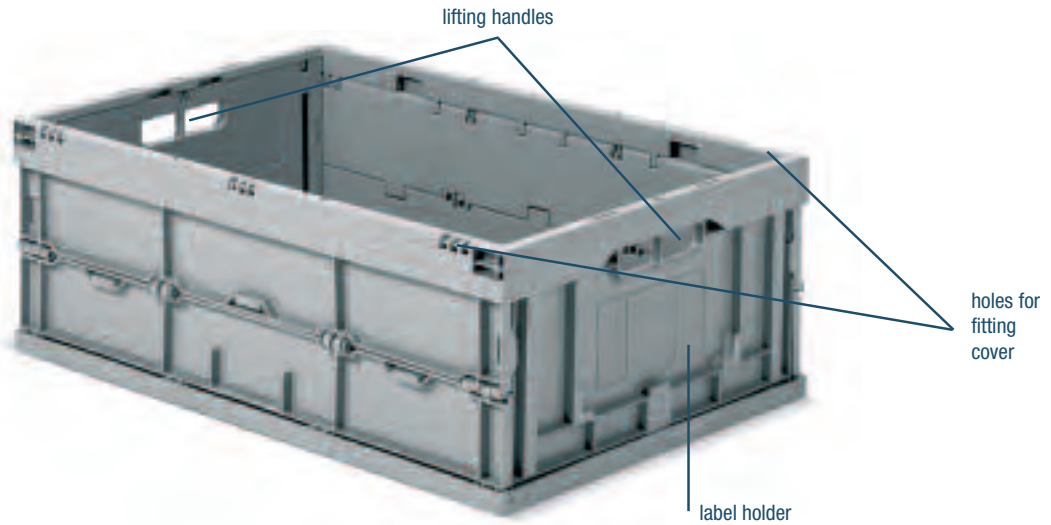

Oil resistant



The stacking containers marked with this symbol can be used to store foodstuffs.

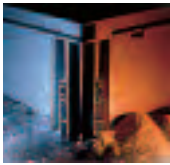

Resistant to high and low temperatures



NETTUNO STACKING CONTAINERS SERIES F PF 400x300

■ 01



■ 01



■ Complete with hinged lid

■ Label holder: ORD. NO. F PZ 9551 00 07 See page G15

■ *On request other colours available

ORD. NO.

DIM. mm

ORD. NO.	DIM. mm
F PF 4851 BB 01	400x300x220 h
External dim. mm	400x300x220 h
Closed dim. mm	400x300x70 h
Capacity litres	22
Weight gr.	1308
Standard colour*	■
Bottom	solid
Long sides	closed
Short sides	closed
Lifting	holes

ORD. NO.

DIM. mm

ORD. NO.	DIM. mm
F PF 4851 BA 01	400x300x230 h
External dim. mm	400x300x230 h
Closed dim. mm	400x300x85 h
Capacity litres	22
Weight gr.	1654
Standard colour*	■
Bottom	solid
Long sides	closed
Short sides	closed
Lifting	holes

GREY F. 01

KEY ■



The stacking containers marked with this symbol can be used to store foodstuffs.



Containers with this symbol are made of completely recyclable plastic material.

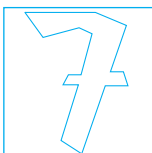

DIMENSIONS = 600x400

SERIES STORAGE NETTUNO

NETTUNO STACKING CONTAINERS
SERIES F PF 600x400

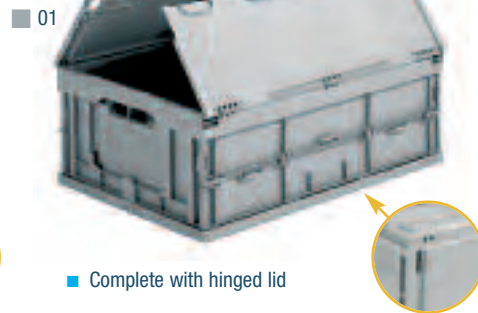
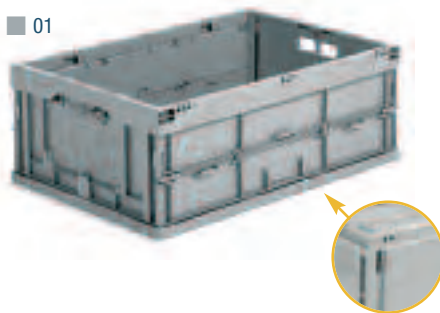

■ Complete with hinged lid

■ Label holder: ORD. NO. F PZ 9751 00 07
See page G15

■ *On request other colours available

ORD. NO.	DIM. mm
F PF 6851 BB 01	600x400x220 h
External dim. mm	600x400x220 h
Closed dim. mm	600x400x68 h
Capacity litres	45
Weight gr.	2170
Standard colour*	■
Bottom	solid
Long sides	closed
Short sides	closed
Lifting	holes

ORD. NO.	DIM. mm
F PF 6851 BA 01	600x400x230 h
External dim. mm	600x400x230 h
Closed dim. mm	600x400x80 h
Capacity litres	45
Weight gr.	2870
Standard colour*	■
Bottom	solid
Long sides	closed
Short sides	closed
Lifting	holes

NETTUNO STACKING CONTAINERS
SERIES F PF 600x400

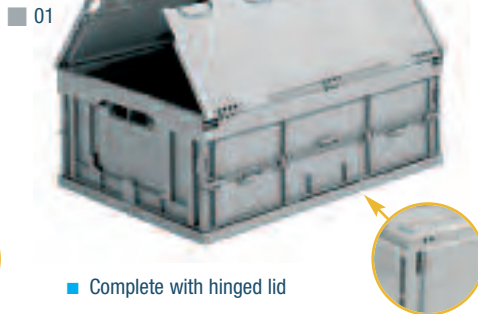
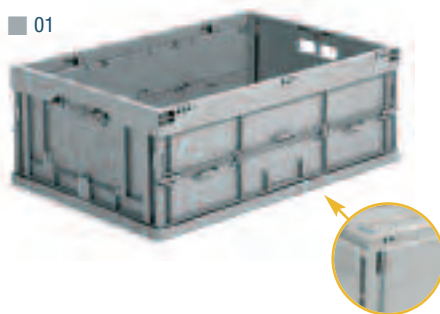

■ Complete with hinged lid

■ Label holder: ORD. NO. F PZ 9751 00 07
See page G15

■ *On request other colours available

ORD. NO.	DIM. mm
F PF 7651 BB 01	600x400x320 h
External dim. mm	600x400x320 h
Closed dim. mm	600x400x70 h
Capacity litres	65
Weight gr.	2642
Standard colour*	■
Bottom	solid
Long sides	closed
Short sides	closed
Lifting	holes

ORD. NO.	DIM. mm
F PF 7651 BA 01	600x400x330 h
External dim. mm	600x400x330 h
Closed dim. mm	600x400x82 h
Capacity litres	65
Weight gr.	3338
Standard colour*	■
Bottom	solid
Long sides	closed
Short sides	closed
Lifting	holes

■ KEY



The stacking containers marked with this symbol can be used to store foodstuffs.



Containers with this symbol are made of completely recyclable plastic material.

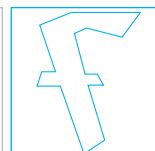

GREY
F.....01

SERIES STORAGE ZEUS

- SHOCK RESISTANT
- AVAILABLE IN 5 COLOURS
- STRONG STACKING EDGES

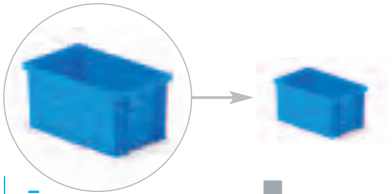

-	■
-	■
-	■
-	■
-	■
ORD. NO. F PJ 0151 00 04	■
-	■
External dim. mm	145x90x70 h
Internal dim. mm	123x80x63 h
Capacity litres	0,9
Weight gr.	70

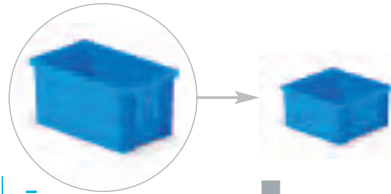

-	■
-	■
-	■
-	■
-	■
ORD. NO. F PJ 1751 00 04	■
-	■
External dim. mm	145x140x70 h
Internal dim. mm	127x123x63 h
Capacity litres	1,4
Weight gr.	90



size 272-2

ORD. NO. F PJ 2551 00 01	■
ORD. NO. F PJ 2551 00 02	■
ORD. NO. F PJ 2551 00 03	■
ORD. NO. F PJ 2551 00 04	■
ORD. NO. F PJ 2551 00 05	■
External dim. mm	200x140x130 h
Internal dim. mm	186x125x110 h
Capacity litres	3,6
Weight gr.	265



size 272-3A2

ORD. NO. F PJ 3351 00 01	■
ORD. NO. F PJ 3351 00 02	■
ORD. NO. F PJ 3351 00 03	■
ORD. NO. F PJ 3351 00 04	■
ORD. NO. F PJ 3351 00 05	■
External dim. mm	300x200x145 h
Internal dim. mm	284x181x130 h
Capacity litres	8,7
Weight gr.	525



size 272-4A2

ORD. NO. F PJ 5751 00 01	■
ORD. NO. F PJ 5751 00 02	■
ORD. NO. F PJ 5751 00 03	■
ORD. NO. F PJ 5751 00 04	■
ORD. NO. F PJ 5751 00 05	■
External dim. mm	450x300x120 h
Internal dim. mm	426x275x106 h
Capacity litres	16,2
Weight gr.	1000



size 272-4

ORD. NO. F PJ 6551 00 01	■
ORD. NO. F PJ 6551 00 02	■
ORD. NO. F PJ 6551 00 03	■
ORD. NO. F PJ 6551 00 04	■
ORD. NO. F PJ 6551 00 05	■
External dim. mm	450x300x200 h
Internal dim. mm	428x277x183 h
Capacity litres	27
Weight gr.	1370



size 272-4A5

ORD. NO. F PJ 7351 00 01	■
ORD. NO. F PJ 7351 00 02	■
ORD. NO. F PJ 7351 00 03	■
ORD. NO. F PJ 7351 00 04	■
ORD. NO. F PJ 7351 00 05	■
External dim. mm	450x300x300 h
Internal dim. mm	426x277x286 h
Capacity litres	40,5
Weight gr.	1865



size 272-5

ORD. NO. F PJ 8951 00 01	■
ORD. NO. F PJ 8951 00 02	■
ORD. NO. F PJ 8951 00 03	■
ORD. NO. F PJ 8951 00 04	■
ORD. NO. F PJ 8951 00 05	■
External dim. mm	630x450x300 h
Internal dim. mm	605x428x275 h
Capacity litres	85
Weight gr.	4390

GREY F.01 GREEN F.02 RED F.03 BLUE F.04 YELLOW F.05

KEY ■

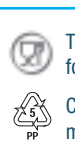
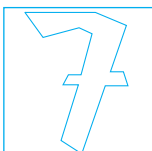

The stacking containers marked with this symbol can be used to store foodstuffs.



Containers with this symbol are made of completely recyclable plastic material.



SIZES = 01 / 0 / 1 / 2 / 3A2 / 3

SERIES STORAGE ZEUS - COMPAT



carrying handle



bar and carrying handle

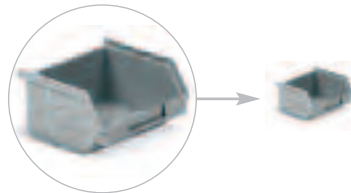

■ SHOCK RESISTANT

■ AVAILABLE IN 5 COLOURS

■ STRONG STACKING EDGES

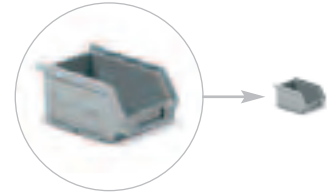

size 01

ORD. NO. F PL 0151 00 01 ■

ORD. NO. F PL 0151 00 02 ■

ORD. NO. F PL 0151 00 03 ■

ORD. NO. F PL 0151 00 04 ■

ORD. NO. F PL 0151 00 05 ■

External dim. mm 72/60x45x32 h

Internal dim. mm 55x38x32 h

Capacity litres 0,08

Weight gr. 18



size 0

ORD. NO. F PL 0951 00 01 ■

ORD. NO. F PL 0951 00 02 ■

ORD. NO. F PL 0951 00 03 ■

ORD. NO. F PL 0951 00 04 ■

ORD. NO. F PL 0951 00 05 ■

External dim. mm 85/65x95x45 h

Internal dim. mm 63x90x43 h

Capacity litres 0,25

Weight gr. 40

size 1

ORD. NO. F PM 1751 00 01 ■

ORD. NO. F PM 1751 00 02 ■

ORD. NO. F PM 1751 00 03 ■

ORD. NO. F PM 1751 00 04 ■

ORD. NO. F PM 1751 00 05 ■

External dim. mm 160/140x95x75 h

Internal dim. mm 134x88x65 h

Capacity litres 1

Weight gr. 100



size 2

ORD. NO. F PM 2551 00 01 ■

ORD. NO. F PM 2551 00 02 ■

ORD. NO. F PM 2551 00 03 ■

ORD. NO. F PM 2551 00 04 ■

ORD. NO. F PM 2551 00 05 ■

External dim. mm 230/200x140x130 h

Internal dim. mm 190x124x111 h

Capacity litres 3,8

Weight gr. 280



size 3A2

ORD. NO. F PM 3351 00 01 ■

ORD. NO. F PM 3351 00 02 ■

ORD. NO. F PM 3351 00 03 ■

ORD. NO. F PM 3351 00 04 ■

ORD. NO. F PM 3351 00 05 ■

External dim. mm 350/300x200x145 h

Internal dim. mm 285x182x130 h

Capacity litres 9,4

Weight gr. 585



size 3

ORD. NO. F PM 4151 00 01 ■

ORD. NO. F PM 4151 00 02 ■

ORD. NO. F PM 4151 00 03 ■

ORD. NO. F PM 4151 00 04 ■

ORD. NO. F PM 4151 00 05 ■

External dim. mm 350/300x200x200 h

Internal dim. mm 278x180x187 h

Capacity litres 12,5

Weight gr. 735

■ KEY

GREY
F. 01GREEN
F. 02RED
F. 03BLUE
F. 04YELLOW
F. 05

The stacking containers marked with this symbol can be used to store foodstuffs.



Containers with this symbol are made of completely recyclable plastic material.



SERIE STORAGE ZEUS - COMPAT



size 3L5

ORD. NO. F PL 4951 00 01	■
ORD. NO. F PL 4951 00 02	■
ORD. NO. F PL 4951 00 03	■
ORD. NO. F PL 4951 00 04	■
ORD. NO. F PL 4951 00 05	■

External dim. mm	350/300x450x145 h
Internal dim. mm	294x432x131 h
Capacity litres	19
Weight gr.	1060



size 4A2

ORD. NO. F PM 5751 00 01	■
ORD. NO. F PM 5751 00 02	■
ORD. NO. F PM 5751 00 03	■
ORD. NO. F PM 5751 00 04	■
ORD. NO. F PM 5751 00 05	■

External dim. mm	500/450x300x145 h
Internal dim. mm	440x278x129 h
Capacity litres	20
Weight gr.	1215



size 4

ORD. NO. F PM 6551 00 01	■
ORD. NO. F PM 6551 00 02	■
ORD. NO. F PM 6551 00 03	■
ORD. NO. F PM 6551 00 04	■
ORD. NO. F PM 6551 00 05	■

External dim. mm	500/450x300x200 h
Internal dim. mm	435x281x186 h
Capacity litres	28
Weight gr.	1355



size 4A5

ORD. NO. F PM 7351 00 01	■
ORD. NO. F PM 7351 00 02	■
ORD. NO. F PM 7351 00 03	■
ORD. NO. F PM 7351 00 04	■
ORD. NO. F PM 7351 00 05	■

External dim. mm	500/450x300x300 h
Internal dim. mm	432x280x287 h
Capacity litres	42
Weight gr.	1925



size 5P4

ORD. NO. F PL 8151 00 01	■
ORD. NO. F PL 8151 00 02	■
ORD. NO. F PL 8151 00 03	■
ORD. NO. F PL 8151 00 04	■
ORD. NO. F PL 8151 00 05	■

External dim. mm	520/450x450x300 h
Internal dim. mm	431x430x277 h
Capacity litres	63
Weight gr.	3485



size 5

ORD. NO. F PL 8951 00 01	■
ORD. NO. F PL 8951 00 02	■
ORD. NO. F PL 8951 00 03	■
ORD. NO. F PL 8951 00 04	■
ORD. NO. F PL 8951 00 05	■

External dim. mm	700/630x450x300 h
Internal dim. mm	615x427x275 h
Capacity litres	88
Weight gr.	4330

GREY F.01 GREEN F.02 RED F.03 BLUE F.04 YELLOW F.05

KEY ■

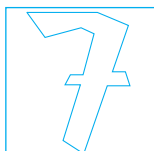

The stacking containers marked with this symbol can be used to store foodstuffs.

Containers with this symbol are made of completely recyclable plastic material.



TROUGHS



- ORD. NO. F PJ 2551 00 01 ■
- ORD. NO. F PJ 2551 00 02 ■
- ORD. NO. F PJ 2551 00 03 ■
- ORD. NO. F PJ 2551 00 04 ■
- ORD. NO. F PJ 2551 00 05 ■

External dim. mm 200x140x130 h

No. of troughs 6 per ORD. NO. F PL 8151 00 ..
8 per ORD. NO. F PL 8951 00 ..



container ORD. NO. F PL 8951 00 04
with 8 troughs ORD. NO. F PJ 2551 00 01



container ORD. NO. F PL 8151 00 03
with 6 troughs ORD. NO. F PJ 2551 00 05

TROUGHS WITH 2/4 COMPARTMENTS FOR CONTAINERS SERIES F PM



■ 01

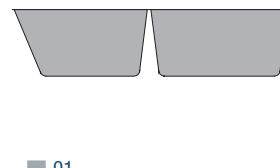

■ 01

Troughs with 2 compartments

ORD. NO.

F PP 0551 00 01

External dim. mm 150/120x90x35 h

No. of troughs 2

For containers ORD. NO. F PM 1751 00 ..



container ORD. NO. F PM 2551 00 04
with 1 trough ORD. NO. F PP 1551 00 01

Troughs with 4 compartments

ORD. NO.

F PP 1051 00 01

External dim. mm 150/120x90x35 h

No. of troughs 4

For containers ORD. NO. F PM 1751 00 ..

ORD. NO.

F PP 1551 00 01

External dim. mm 205/160x125x60 h

No. of troughs 2

For containers ORD. NO. F PM 2551 00 ..



container ORD. NO. F PM 2551 00 03
with 1 trough ORD. NO. F PP 2051 00 01

ORD. NO.

F PP 2051 00 01

External dim. mm 205/160x125x60 h

No. of troughs 4

For containers ORD. NO. F PM 2551 00 ..

KEY

GREY
F.01

GREEN
F.02

RED
F.03

BLUE
F.04

YELLOW
F.05



The stacking containers marked with this symbol can be used to store foodstuffs.



Containers with this symbol are made of completely recyclable plastic material.



SERIES STORAGE ZEUS – COMPAT

FRONT TO BACK METAL DIVIDER FOR CONTAINERS SERIES F PL – F PM



■ 99

Front to back metal divider with pair of supports

ORD. NO. F ND 0211 01 99

For containers ORD. NO. F PL 8151 00 ..

ORD. NO. F ND 0231 01 99

For containers ORD. NO. F PL 8951 00 ..



Supplementary front to back divider

ORD. NO. F ND 0211 00 99

For containers ORD. NO. F PL 8151 00 ..

ORD. NO. F ND 0231 00 99

For containers ORD. NO. F PL 8951 00 ..



■ 99

Front to back metal divider

ORD. NO. F ND 0110 00 99

For containers ORD. NO. F PM 3351 00 ..

ORD. NO. F ND 0140 00 99

For containers ORD. NO. F PM 4151 00 ..

ORD. NO. F ND 0150 00 99

For containers ORD. NO. F PL 4951 00 ..

ORD. NO. F ND 0160 00 99

For containers ORD. NO. F PM 5751 00 ..

ORD. NO. F ND 0180 00 99

For containers ORD. NO. F PM 6551 00 ..

ORD. NO. F ND 0170 00 99

For containers ORD. NO. F PM 7351 00 ..

SUB-DIVIDERS FOR CONTAINERS SERIES F PM



Sub-divider

ORD. NO. F ND 1110 00 99

For containers ORD. NO. F PM 6551 00 ..

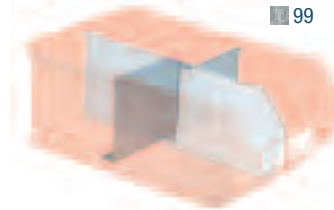

■ 99

FRONT TO BACK PLASTIC DIVIDER FOR CONTAINERS SERIES F PL – F PM

Front to back plastic divider

ORD. NO. F PZ 1071 00 07

For containers ORD. NO. F PM 3351 00 ..

ORD. NO. F PZ 1571 00 07

For containers ORD. NO. F PM 4151 00 ..

ORD. NO. F PZ 2071 00 07

For containers ORD. NO. F PL 4951 00 ..

ORD. NO. F PZ 2571 00 07

For containers ORD. NO. F PM 6551 00 ..

ORD. NO. F PZ 3071 00 07

For containers ORD. NO. F PM 7351 00 ..

■ 07

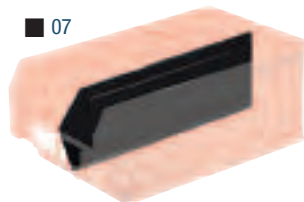

GUARANTEE
5
YEARS



■ GALVANISED
F.....99

■ BLACK
F.....07

INFO ■

www.famispa.com





■ 99

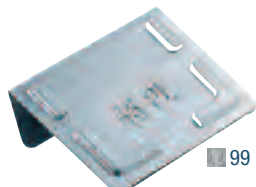

■ 99

ORD. NO. F ND 2110 00 99

ORD. NO. F ND 2130 00 99

INCLINED LABEL HOLDER

ORD. NO.	FOR CONTAINERS ORD. NO.
F ND 2110 00 99	F PM 3351 00 ..
	F PM 4151 00 ..
	F PM 4251 00 ..
	F PM 6551 00 ..
	F PM 6651 00 ..
	F PM 7351 00 ..
	F PM 7451 00 ..
F ND 2130 00 99	F PL 8151 00 ..
	F PL 8951 00 ..



LABELS FOR STACKING AND STORAGE CONTAINERS

ORD. NO.	FOR CONTAINERS ORD. NO.	DIM. OF SINGLE LABEL mm	NO. OF LABELS PER SHEET
F PL 9020 00 00	F PL 0951 00 ..	49x11	80
F PL 9040 00 00	F PM 1751 00 ..	75x20	36
F PL 9100 00 00	F PM 2551 00 ..	104x33	16
F PL 9060 00 00	F PM 3351 00 ..	77x31	18
	F PL 4951 00 ..		
	F PM 5751 00 ..		
F PL 9080 00 00	F PM 4151 00 ..	77x42	12
	F PM 4251 00 ..		
	F PM 6551 00 ..		
	F PM 6651 00 ..		
	F PM 7351 00 ..		
F PL 9120 00 00	F PL 8151 00 ..	127x39	10
	F PL 8951 00 ..		
	F PL 8151 00 ..		
F PL 9160 00 00	F PL 8951 00 ..	189x85	3
	F PJ 6551 00 ..		
	F PJ 7351 00 ..		
F PL 9140 00 00	F PJ 8951 00 ..	189x82	3
	F PJ 5751 00 ..		

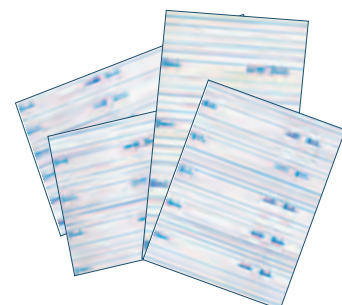

PERSONALISED LOGOS



injection logo

hot printed logo

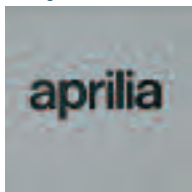

DUST COVER FOR CONTAINERS SERIES F PM



ORD. NO. F PZ 5668 00 96

ORD. NO. F PZ 5368 00 96

ORD. NO. F PZ 6568 00 96

ORD. NO. F PZ 6268 00 96



ORD. NO.	FOR CONTAINERS ORD. NO.
F PZ 5668 00 96	F PM 3351 00 ..
F PZ 5368 00 96	F PM 4151 00 .. / F PM 4251 00 ..
F PZ 6568 00 96	F PM 6551 00 .. / F PM 6651 00 ..
F PZ 6268 00 96	F PM 7351 00 .. / F PM 7451 00 ..

INFO

GALVANISED
F.....99

TRANSPARENT
F.....96



www.famispa.com



SERIES STORAGE STEEL

- 90° BLOCK HANDLE
- AVAILABLE IN 2 COLOURS AND GALVANISED
- EASY CARRIAGE WITH TROLLEYS



90° block handle



Painted stacking container

TROLLEYS FOR LIFTING AND TRANSPORTING METAL STACKING CONTAINERS SERIES F LA

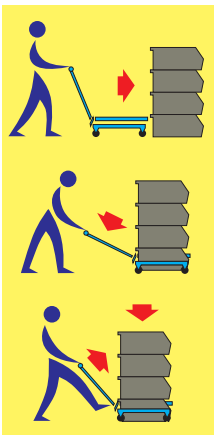

how to use the lifting trolley



■ N.B. Also plastic containers can be carried with this trolley but the first forked container must be of steel.



ORD. NO.	LOAD CAPACITY kg
F CR 0401 00 04	300
Trolley for stacking and storage containers	
ORD. NO. F LS 6500 00 .. / ORD. NO. F LA 6520 00 ..	
2 rubber swivel wheels Ø 125 mm	
2 polyurethane fixed wheels Ø 125 mm	

ORD. NO.	LOAD CAPACITY kg
F CR 0421 00 04	300
Trolley for stacking and storage containers ORD. NO. F LS 8900 00 ..	
ORD. NO. F LS 8100 00 .. / ORD. NO. F LA 8920 00 ..	
2 rubber swivel wheels Ø 125 mm	
2 polyurethane fixed wheels Ø 125 mm	

RAL 5012
F.....04

RAL 7000
F.....01

Hot GALVANISED
F.....99

INFO ■



METAL STACKING CONTAINERS

SERIES STORAGE STEEL



size 272-3A2

- ORD. NO. F LA 3320 00 01
- ORD. NO. F LA 3320 00 02
- ORD. NO. F LA 3320 00 99

External dim. mm	300x200x145 h
Internal dim. mm	290x183x132 h
Capacity litres	8,7



size 272-3

- ORD. NO. F LA 4120 00 01
- ORD. NO. F LA 4120 00 02
- ORD. NO. F LA 4120 00 99

External dim. mm	300x200x200 h
Internal dim. mm	290x186x184 h
Capacity litres	12



size 272-4

- ORD. NO. F LA 6520 00 01
- ORD. NO. F LA 6520 00 02
- ORD. NO. F LA 6520 00 99

External dim. mm	450x300x200 h
Internal dim. mm	442x285x182 h
Capacity litres	27



size 272-4A5

- ORD. NO. F LA 7320 00 01
- ORD. NO. F LA 7320 00 02
- ORD. NO. F LA 7320 00 99

External dim. mm	450x300x300 h
Internal dim. mm	440x280x278 h
Capacity litres	40,5



size 272-5

- ORD. NO. F LA 8920 00 01
- ORD. NO. F LA 8920 00 02
- ORD. NO. F LA 8920 00 99

External dim. mm	630x450x300 h
Internal dim. mm	617x430x278 h
Capacity litres	85

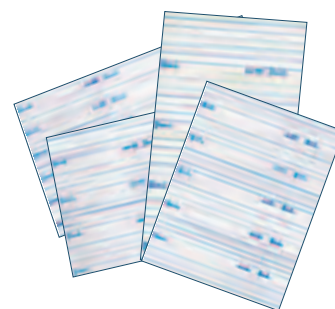

LABEL FOR CONTAINERS

ORD. NO.	FOR STACKING AND STORAGE CONTAINERS ORD. NO.	DIM. SINGLE LABEL mm	NO. LABELS PER SHEET
F LS 9040 00 00	F LA 3320 00 ..	73x37	15
F LS 9060 00 00	F LA 4120 00 .. F LA 6520 00 ..	80x48	12
F LS 9080 00 00	F LA 7320 00 .. F LA 8920 00 ..	102x76	6

INFO

RAL 6011
F.02

RAL 7000
F.01

Hot GALVANISED
F.99



www.famispa.com



SERIES STORAGE STEEL

- 90° BLOCK HANDLE
- IDEAL FOR MATERIAL WASH
- HOLES IN 6 DIFFERENT SIZES
- STAINLESS STEEL AND HEAT GALVANISED



The FAMI perforated stacking containers have been produced to satisfy the requirements to wash the contents without removing. Thanks to this special feature, they are used a lot in processes such as degreasing components directed towards the assembly shop where the washing liquid must be eliminated. They also allow the contents to be aerated if required.

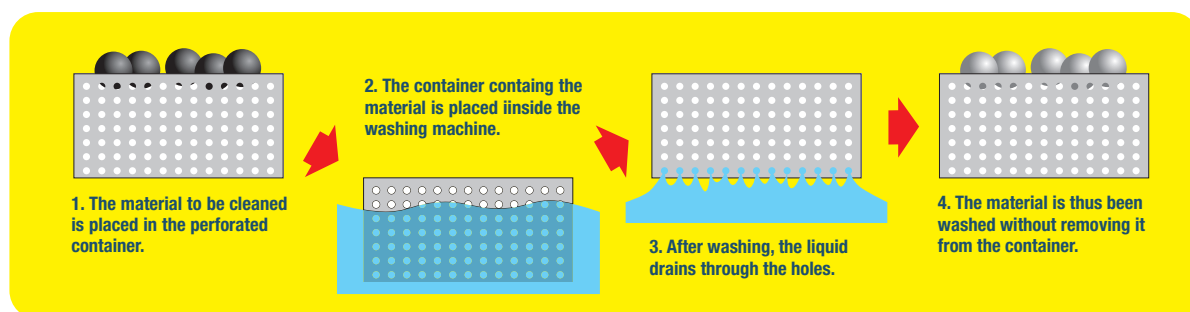
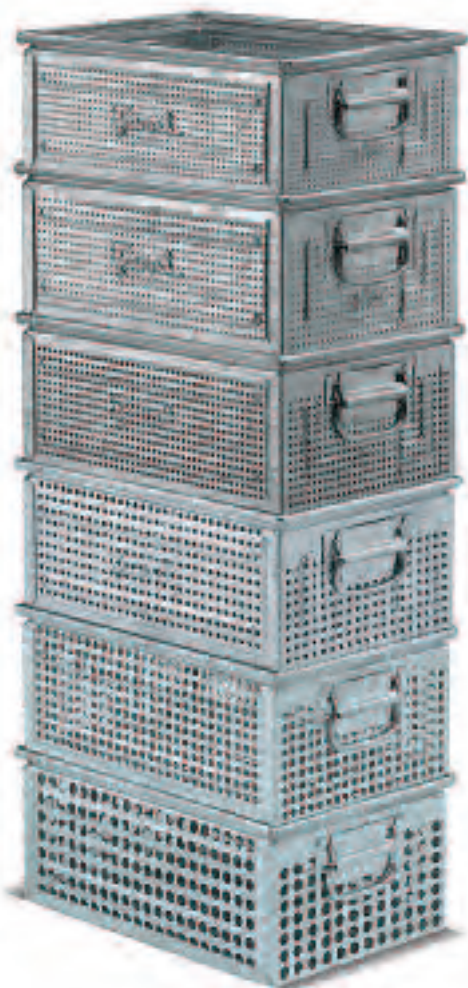

STEEL
F...ZZ

Hot GALVANISED
F...99

INFO ■

www.famispa.com



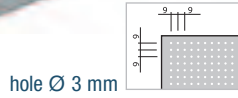

hole Ø 3 mm

size 272-4

ORD. NO. F LA 6510 00 ZZ ■

External dim. mm 450x300x200 h

Internal dim. mm 442x285x182 h

Capacity litres 27

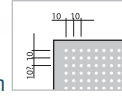

hole Ø 4,2 mm

size 272-4

ORD. NO. F LA 6511 00 99 ■

External dim. mm 450x300x200 h

Internal dim. mm 442x285x182 h

Capacity litres 27

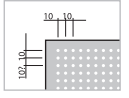

hole Ø 5,5 mm

size 272-4

ORD. NO. F LA 6512 00 99 ■

External dim. mm 450x300x200 h

Internal dim. mm 442x285x182 h

Capacity litres 27

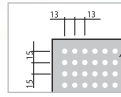

hole Ø 7 mm

size 272-4

ORD. NO. F LA 6513 00 99 ■

External dim. mm 450x300x200 h

Internal dim. mm 442x285x182 h

Capacity litres 27

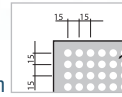

hole Ø 10 mm

size 272-4

ORD. NO. F LA 6515 00 99 ■

External dim. mm 450x300x200 h

Internal dim. mm 442x285x182 h

Capacity litres 27

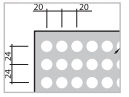

hole Ø 15 mm

size 272-4

ORD. NO. F LA 6517 00 99 ■

External dim. mm 450x300x200 h

Internal dim. mm 442x285x182 h

Capacity litres 27

■ INFO

STEEL
F.ZZ

Hot GALVANISED
F.99



www.famispaspa.com

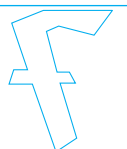

SERIES STORAGE STEEL

- 90° BLOCK HANDLE
- SEVERAL TYPES FOR DIFFERENT NEEDS
- MADE OF PAINTED OR GALVANISED STEEL
- THE FRONT OPENING MAKES THE PICKING OF TO CONTENT EASY



STORAGE CONTAINERS WITH SPECIAL APPLICATIONS



lifting system with fork lift truck



lifting system with fork lift truck

RAL 6011
F.....02RAL 7000
F.....01Hot GALVANISED
F.....99

INFO ■

www.famispa.com

METAL STORAGE CONTAINERS

SERIES STORAGE STEEL



lift bar coupled with
the 90° block handle



size 1

ORD. NO. F LS 1700 00 01 ■

ORD. NO. F LS 1700 00 02 ■

ORD. NO. F LS 1700 00 99 ■

External dim. mm 160/140x95x75 h

Internal dim. mm 138x86x66 h

Capacity litres 1

Without 90° block handle



size 2

ORD. NO. F LS 2500 00 01 ■

ORD. NO. F LS 2500 00 02 ■

ORD. NO. F LS 2500 00 99 ■

External dim. mm 230/200x140x130 h

Internal dim. mm 196x131x113 h

Capacity litres 3,8

Without 90° block handle

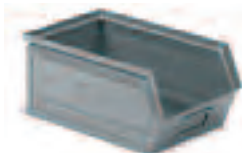

size 3A2

ORD. NO. F LS 3300 00 01 ■

ORD. NO. F LS 3300 00 02 ■

ORD. NO. F LS 3300 00 99 ■

External dim. mm 350/300x200x145 h

Internal dim. mm 298x181x135 h

Capacity litres 9,4

Without 90° block handle



size 3

ORD. NO. F LS 4100 00 01 ■

ORD. NO. F LS 4100 00 02 ■

ORD. NO. F LS 4100 00 99 ■

External dim. mm 350/300x200x200 h

Internal dim. mm 300x185x184 h

Capacity litres 12,5

With 90° block handle



size 3P4

ORD. NO. F LS 4900 00 01 ■

ORD. NO. F LS 4900 00 02 ■

ORD. NO. F LS 4900 00 99 ■

External dim. mm 500/450x200x200 h

Internal dim. mm 448x184x184 h

Capacity litres 18

With 90° block handle



size 4A2

ORD. NO. F LS 5700 00 01 ■

ORD. NO. F LS 5700 00 02 ■

ORD. NO. F LS 5700 00 99 ■

External dim. mm 500/450x300x145 h

Internal dim. mm 448x281x135 h

Capacity litres 20

Without 90° block handle



size 4

ORD. NO. F LS 6500 00 01 ■

ORD. NO. F LS 6500 00 02 ■

ORD. NO. F LS 6500 00 99 ■

External dim. mm 500/450x300x200 h

Internal dim. mm 448x284x185 h

Capacity litres 28

With 90° block handle



size 4A5

ORD. NO. F LS 7300 00 01 ■

ORD. NO. F LS 7300 00 02 ■

ORD. NO. F LS 7300 00 99 ■

External dim. mm 520/450x300x300 h

Internal dim. mm 446x288x278 h

Capacity litres 42

With 90° block handle



size 5P4

ORD. NO. F LS 8100 00 01 ■

ORD. NO. F LS 8100 00 02 ■

ORD. NO. F LS 8100 00 99 ■

External dim. mm 520/450x450x300 h

Internal dim. mm 448x428x278 h

Capacity litres 63

With 90° block handle



size 5

ORD. NO. F LS 8900 00 01 ■

ORD. NO. F LS 8900 00 02 ■

ORD. NO. F LS 8900 00 99 ■

External dim. mm 700/630x450x300 h

Internal dim. mm 630x428x278 h

Capacity litres 88

With 90° block handle

■ INFO

RAL 6011
F.02

RAL 7000
F.01

Hot GALVANISED
F.99



www.famispa.com



SERIES STORAGE STEEL

STORAGE CONTAINERS WITH DOUBLE CARRYING BARS



size 4

ORD. NO. F LS 6501 00 01 ■

ORD. NO. F LS 6501 00 02 ■

ORD. NO. F LS 6501 00 99 ■

External dim. mm 500/450x300x200 h

Internal dim. mm 448x284x185 h

Capacity litres 28

With 90° block handle



size 4A5

ORD. NO. F LS 7301 00 01 ■

ORD. NO. F LS 7301 00 02 ■

ORD. NO. F LS 7301 00 99 ■

External dim. mm 520/450x300x300 h

Internal dim. mm 446x288x278 h

Capacity litres 42

With 90° block handle



size 5P4

ORD. NO. F LS 8101 00 01 ■

ORD. NO. F LS 8101 00 02 ■

ORD. NO. F LS 8101 00 99 ■

External dim. mm 520/450x450x300 h

Internal dim. mm 448x428x278 h

Capacity litres 63

With 90° block handle



size 5

ORD. NO. F LS 8901 00 01 ■

ORD. NO. F LS 8901 00 02 ■

ORD. NO. F LS 8901 00 99 ■

External dim. mm 700/630x450x300 h

Internal dim. mm 630x428x278 h

Capacity litres 88

With 90° block handle

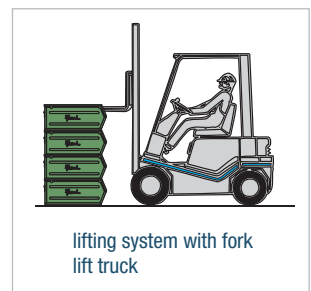

STORAGE CONTAINERS WITH SLIDING BASE



size 5P4

ORD. NO. F LS 8110 00 01 ■

ORD. NO. F LS 8110 00 02 ■

ORD. NO. F LS 8110 00 99 ■

External dim. mm 520/450x450x390 h

Internal dim. mm 448x428x278 h

Capacity litres 63

With 90° block handle



size 5

ORD. NO. F LS 8910 00 01 ■

ORD. NO. F LS 8910 00 02 ■

ORD. NO. F LS 8910 00 99 ■

External dim. mm 700/630x450x390 h

Internal dim. mm 630x428x278 h

Capacity litres 88

With 90° block handle

RAL 6011
F.02RAL 7000
F.01Hot GALVANISED
F.99

INFO ■

www.famispa.com

LABELS / FRONT TO BACK METAL DIVIDERS

SERIES STORAGE STEEL



■ 99

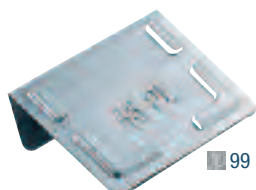

■ 99

ORD. NO. F ND 2120 00 99

ORD. NO. F ND 2110 00 99

INCLINED LABEL HOLDER

ORD. NO.

**FOR CONTAINERS
ORD. NO.**

F ND 2120 00 99	F LS 7300 00 ..
	F LS 7301 00 ..
	F LS 8100 00 ..
	F LS 8101 00 ..
	F LS 8110 00 ..
	F LS 8900 00 ..
	F LS 8901 00 ..

F ND 2110 00 99

F LS 4100 00 ..
F LS 6500 00 ..
F LS 6501 00 ..



**LABEL FOR METAL
STORAGE CONTAINERS**

ORD. NO.

**FOR STORAGE
CONTAINERS ORD. NO.**

**DIM. SINGLE
LABEL mm**

**NO. LABELS
PER SHEET**

F LS 9020 00 00	F LS 1700 00 ..	47x17	60
	F LS 2500 00 ..		
F LS 9040 00 00	F LS 3300 00 ..	73x37	15
	F LS 5700 00 ..		
	F LS 4100 00 ..		
F LS 9060 00 00	F LS 4900 00 ..	80x48	12
	F LS 6500 00 ..		
	F LS 6501 00 ..		
	F LS 7300 00 ..		
	F LS 7301 00 ..		
F LS 9080 00 00	F LS 8900 00 ..	102x76	6
	F LS 8901 00 ..		
	F LS 8910 00 ..		
	F LS 8100 00 ..		
	F LS 8101 00 ..		
	F LS 8110 00 ..		
	F LS 8110 00 ..		

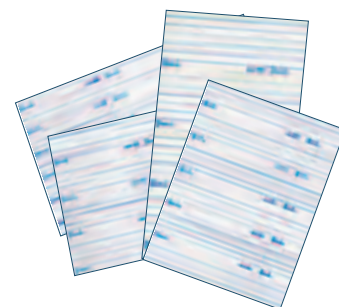

FRONT TO BACK METAL DIVIDERS

■ 99

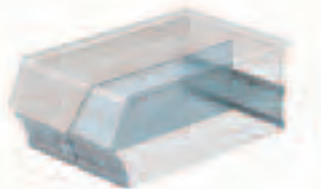

Front to back metal dividers with pair of supports

ORD. NO. F ND 0130 01 99

For containers ORD. NO. F LS 4100 00 ..

ORD. NO. F ND 0190 01 99

For containers ORD. NO. F LS 6500 00 ..
F LS 6501 00 ..

ORD. NO. F ND 0221 01 99

For containers ORD. NO. F LS 7300 00 ..
F LS 7301 00 ..

ORD. NO. F ND 0221 02 99

For containers ORD. NO. F LS 8100 00 ..
F LS 8101 00 ..
F LS 8110 00 ..

ORD. NO. F ND 0241 01 99

For containers ORD. NO. F LS 8900 00 ..
F LS 8901 00 ..
F LS 8910 00 ..

Additional front to back metal divider

ORD. NO. F ND 0130 00 99

For containers ORD. NO. F LS 4100 00 ..

ORD. NO. F ND 0190 00 99

For containers ORD. NO. F LS 6500 00 ..
F LS 6501 00 ..

ORD. NO. F ND 0221 00 99

For containers ORD. NO. F LS 7300 00 ..
F LS 7301 00 ..
F LS 8100 00 ..
F LS 8101 00 ..
F LS 8110 00 ..

ORD. NO. F ND 0241 00 99

For containers ORD. NO. F LS 8900 00 ..
F LS 8901 00 ..
F LS 8910 00 ..



■ INFO

RAL 6011
F.02

RAL 7000
F.01

Hot GALVANISED
F.99



www.famispa.com



SERIES STORAGE MULTIBOX

- SHOCK RESISTANT WALLS
- AVAILABLE IN 10 DIFFERENT SIZES



Stacking housings for Multibox boxes



The galvanised steel safety guard prevents the boxes from accidentally falling out of the stacking housings.



Transparent polystyrene dividers and labels available.



A special handle, supplied on request, makes it easy to lift and carry the Multibox series F PK boxes.



BLUE
F.....04

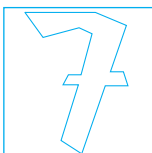

KEY ■



Containers with this symbol are made of completely recyclable plastic material.



MULTIBOX BOXES

SERIES STORAGE MULTIBOX

■ 04



ORD. NO.	DIM. mm
F PK 0551 00 04	300x120x100 h
External dim. mm	300x120x100 h
Internal dim. mm	255x94x89 h
Max q.ty of transversal dividers which can be inserted	4 pcs ORD. NO. F PK 7068 00 96

■ 04



ORD. NO.	DIM. mm
F PK 1551 00 04	400x120x100 h
External dim. mm	400x120x100 h
Internal dim. mm	358x98x89 h
Max q.ty of transversal dividers which can be inserted	6 pcs ORD. NO. F PK 7068 00 96

■ 04



ORD. NO.	DIM. mm
F PK 3051 00 04	500x120x100 h
External dim. mm	500x120x100 h
Internal dim. mm	460x94x89 h
Max q.ty of transversal dividers which can be inserted	8 pcs ORD. NO. F PK 7068 00 96

■ 04



ORD. NO.	DIM. mm
F PK 1051 00 04	300x160x100 h
External dim. mm	300x160x100 h
Internal dim. mm	260x135x89 h
Max q.ty of transversal dividers which can be inserted	4 pcs ORD. NO. F PK 7368 00 96

■ 04



ORD. NO.	DIM. mm
F PK 2051 00 04	400x160x100 h
External dim. mm	400x160x100 h
Internal dim. mm	358x135x90 h
Max q.ty of transversal dividers which can be inserted	6 pcs ORD. NO. F PK 7368 00 96

■ 04



ORD. NO.	DIM. mm
F PK 3551 00 04	500x160x100 h
External dim. mm	500x160x100 h
Internal dim. mm	460x135x89 h
Max q.ty of transversal dividers which can be inserted	8 pcs ORD. NO. F PK 7368 00 96

■ 04



ORD. NO.	DIM. mm
F PK 4551 00 04	600x160x100 h
External dim. mm	600x160x100 h
Internal dim. mm	560x135x90 h
Max q.ty of transversal dividers which can be inserted	10 pcs ORD. NO. F PK 7368 00 96

■ 04



ORD. NO.	DIM. mm
F PK 2551 00 04	400x240x100 h
External dim. mm	400x240x100 h
Internal dim. mm	358x215x89 h
Max q.ty of transversal dividers which can be inserted	6 pcs ORD. NO. F PK 7668 00 96

■ 04



ORD. NO.	DIM. mm
F PK 4051 00 04	500x240x100 h
External dim. mm	500x240x100 h
Internal dim. mm	462x214x89 h
Max q.ty of transversal dividers which can be inserted	8 pcs ORD. NO. F PK 7668 00 96

NEW

■ 04



ORD. NO.	DIM. mm
F PK 2751 00 04	435x140x80 h
External dim. mm	435x140x80 h
Internal dim. mm	420/405x125x70 h
Max q.ty of transversal dividers which can be inserted	7 pcs ORD. NO. F PK 7268 00 96



■ KEY

BLUE
F.....04

Containers with this symbol are made of completely recyclable plastic material.



SERIES STORAGE MULTIBOX

HANDLE



■ 04



ORD. NO.	DIM. mm
F PK 6351 00 04	120x80 h
For boxes ORD. NO.	F PK 1051 00 04 F PK 2051 00 04 F PK 3551 00 04 F PK 4551 00 04

■ 04



ORD. NO.	DIM. mm
F PK 6051 00 04	70x90 h
For boxes ORD. NO.	F PK 0551 00 04 F PK 1551 00 04 F PK 3051 00 04

■ 04

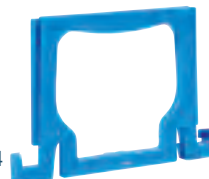

ORD. NO.	DIM. mm
F PK 6651 00 04	110x90 h
For boxes ORD. NO.	F PK 2551 00 04 F PK 4051 00 04



fitting handle
F PK 6351 00 04



fitting handle
F PK 6051 00 04, F PK 6651 00 04

SAFETY GUARDS ■ 99

ORD. NO.	Ø mm
F PK 9410 00 99	3
For boxes ORD. NO.	F PK 0551 00 04 F PK 1551 00 04 F PK 3051 00 04

ORD. NO.	Ø mm
F PK 9420 00 99	3
For boxes ORD. NO.	F PK 1051 00 04 F PK 2051 00 04 F PK 3551 00 04 F PK 4551 00 04 F PK 2551 00 04 F PK 4051 00 04

The safety guards prevent the boxes from falling out by accident

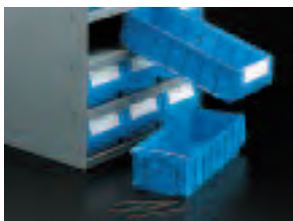

FRONT TO BACK DIVIDERS



■ 99



■ 99

ORD. NO.	DIM. mm	FOR BOXES ORD. NO.
F PK 9230 00 99	268x88 h	F PK 0551 00 04 F PK 1051 00 04
F PK 9240 00 00	368x88 h	F PK 1551 00 04 F PK 2051 00 04 F PK 2551 00 04

ORD. NO.	DIM. mm	FOR BOXES ORD. NO.
F PK 9250 00 00	468x88 h	F PK 3051 00 04 F PK 3551 00 04 F PK 4051 00 04
F PK 9260 00 00	568x88 h	F PK 4551 00 04

■ BLUE
F. 04

■ GALVANISED
F. 99

KEY ■



Handles with this symbol are made of completely recyclable plastic material.

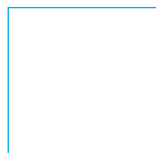
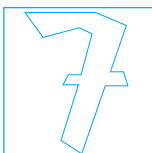

TRANSVERSAL DIVIDERS



96



ORD. NO.	DIM. mm
F PK 7068 00 96	100x90 h

For boxes ORD. NO. F PK 0551 00 04
F PK 1551 00 04
F PK 3051 00 04

96



ORD. NO.	DIM. mm
F PK 7368 00 96	145x90 h

For boxes ORD. NO. F PK 1051 00 04
F PK 2051 00 04
F PK 3551 00 04
F PK 4551 00 04

96



ORD. NO.	DIM. mm
F PK 7668 00 96	225x90 h

For boxes ORD. NO. F PK 2551 00 04
F PK 4051 00 04

96



ORD. NO.	DIM. mm
F PK 7268 00 96	137x75 h

For boxes ORD. NO. F PK 2751 00 04



LABELS FOR BOXES

ORD. NO.	FOR BOXES ORD. NO.	DIM. SINGLE LABEL mm	NO. LABELS PER SHEET
F PK 9540 00 00	F PK 0551 00 04	81x42	12
	F PK 1551 00 04		
	F PK 3051 00 04		
F PK 9580 00 00	F PK 1051 00 04	121x44	8
	F PK 2051 00 04		
	F PK 3551 00 04		
	F PK 4551 00 04		
	F PK 2751 00 04		
F PK 9600 00 00	F PK 2551 00 04	200x43	6
	F PK 4051 00 04		

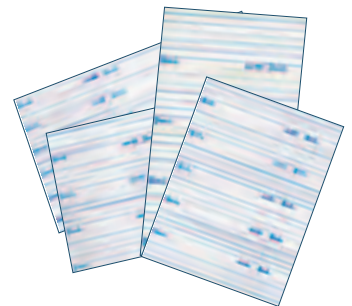

LABELS FOR DIVIDERS

ORD. NO.	FOR BOXES ORD. NO.	DIM. SINGLE LABEL mm	NO. LABELS PER SHEET
F PK 9520 00 00	F PK 7068 00 96	80x24	24
	F PK 7268 00 96		
F PK 9560 00 00	F PK 7368 00 96	121x24	16
	F PK 7668 00 96		



KEY



Dividers with this symbol are made of completely recyclable plastic material.

TRANSPARENT
F. 99

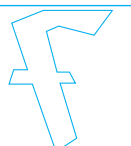

SERIES STORAGE MULTIBOX

STACKING HOUSINGS FOR MULTIBOX BOXES



Stacking housings with tabs for fixing the containers mounted one on the top of the other. The stacking housing must be fitted to the wall with 2 Ø 8 mm screws.

F PK 9030 00 01



F PK 9040 00 01



F PK 9050 00 01



F PK 9060 00 01

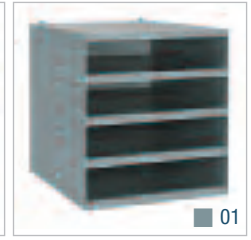

STACKING HOUSING WITHOUT MULTIBOX

STACKING HOUSING WITH MULTIBOX

NO. MULTIBOX INSERTED

F PK 9030 00 01

DIM. 500x300x545 mm h

F PK 9030 01 01*

F PK 9030 02 01*

F PK 9030 03 01*

F PK 9040 00 01

DIM. 500x400x545 mm h

F PK 9040 01 01*

F PK 9040 02 01*

F PK 9040 03 01*

F PK 9040 04 01*

F PK 9040 05 01*

F PK 9040 06 01*

F PK 9040 07 01*

F PK 9050 00 01

DIM. 500x500x545 mm h

F PK 9050 01 01*

F PK 9050 02 01*

F PK 9050 03 01*

F PK 9050 04 01*

F PK 9050 05 01*

F PK 9050 06 01*

F PK 9050 07 01*

F PK 9060 00 01

DIM. 500x600x545 mm h

F PK 9060 02 01*

16 pcs ORD. NO. F PK 0551 00 04

12 pcs ORD. NO. F PK 1051 00 04

8 pcs ORD. NO. F PK 0551 00 04

6 pcs ORD. NO. F PK 1051 00 04

16 pcs ORD. NO. F PK 1551 00 04

12 pcs ORD. NO. F PK 2051 00 04

8 pcs ORD. NO. F PK 1551 00 04

6 pcs ORD. NO. F PK 2051 00 04

8 pcs ORD. NO. F PK 2551 00 04

8 pcs ORD. NO. F PK 1551 00 04

4 pcs ORD. NO. F PK 2551 00 04

6 pcs ORD. NO. F PK 2051 00 04

4 pcs ORD. NO. F PK 2551 00 04

2 pcs ORD. NO. F PK 2551 00 04

16 pcs ORD. NO. F PK 3051 00 04

12 pcs ORD. NO. F PK 3551 00 04

8 pcs ORD. NO. F PK 3051 00 04

6 pcs ORD. NO. F PK 3551 00 04

8 pcs ORD. NO. F PK 4051 00 04

8 pcs ORD. NO. F PK 3051 00 04

4 pcs ORD. NO. F PK 4051 00 04

6 pcs ORD. NO. F PK 3551 00 04

4 pcs ORD. NO. F PK 4051 00 04

4 pcs ORD. NO. F PK 3051 00 04

6 pcs ORD. NO. F PK 3551 00 04

2 pcs ORD. NO. F PK 4051 00 04

12 pcs ORD. NO. F PK 4551 00 04

*Including guide rails and safety guards for boxes



F PK 9030 01 01
F PK 9040 01 01
F PK 9050 01 01



F PK 9030 02 01
F PK 9040 02 01
F PK 9050 02 01
F PK 9060 02 01



F PK 9030 03 01
F PK 9040 03 01
F PK 9050 03 01



F PK 9040 04 01
F PK 9050 04 01



F PK 9040 05 01
F PK 9050 05 01



F PK 9040 06 01
F PK 9050 06 01



F PK 9040 07 01
F PK 9050 07 01

RAL 7000
F.....01

INFO ■

www.famispa.com



BASE PLINTHS

ORD. NO.	DIM. mm	FOR STACK. HOUSING ORD. NO.
F PK 9135 00 01	485x275x90 h	F PK 9030 00 01
F PK 9145 00 01	485x375x90 h	F PK 9040 00 01
F PK 9155 00 01	485x475x90 h	F PK 9050 00 01
F PK 9165 00 01	485x575x90 h	F PK 9060 00 01

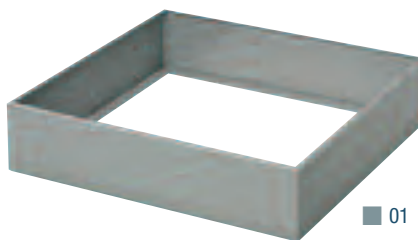

fitting the base plinth

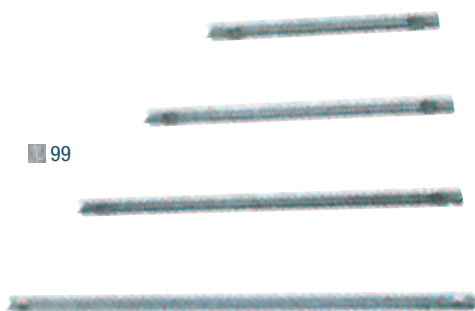

GUIDES

ORD. NO.	FOR STACKING HOUSING ORD. NO.
F ST 9830 00 99	F PK 9030 00 01
F ST 9840 00 99	F PK 9040 00 01
F ST 9850 00 99	F PK 9050 00 01
F ST 9860 00 99	F PK 9060 00 01

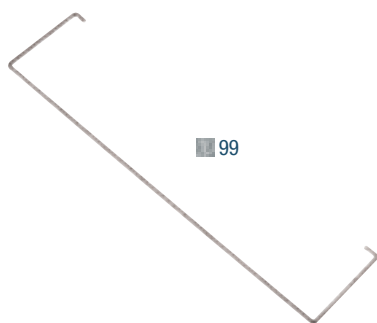

SAFETY GUARDS FOR STACKING HOUSING

ORD. NO.	FOR STACKING HOUSING ORD. NO.
F PK 9360 00 99	F PK 9030 00 01
	F PK 9040 00 01
	F PK 9050 00 01
	F PK 9060 00 01

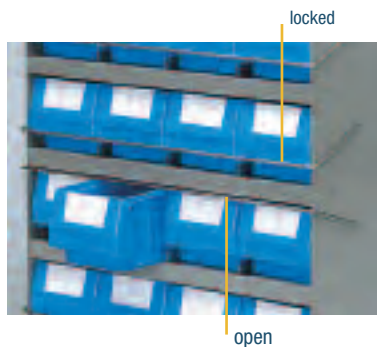

INFO



www.famispa.com

GALVANISED
F... ..99

RAL 7000
F... ..01



SERIES STORAGE PRACTIBOX

- ABS STRUCTURE
- TRANSPARENT POLYSTYRENE COMPARTMENTS WITH HIGH MECHANICAL RESISTANCE
- EASY COMPARTMENTS FRONT OPENING

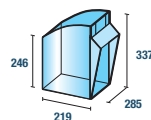
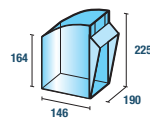
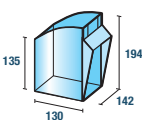
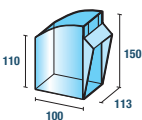
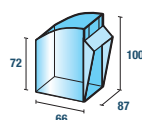
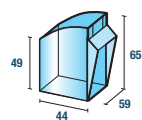

Top-box case

- FOR THE COMPARTMENTS CLEANING THE USE OF SOLVENTS IS NOT SUGGESTED



Vertical system



Container trolley



Rotary tower

COLOUR OF CONTAINERS
RAL 7000 F.01

COLOUR OF COMPARTMENTS
TRANSPARENT F.96

INFO ■

www.famispa.com

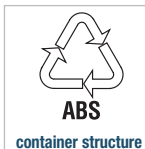

LENGTH = 600 mm

SERIES STORAGE PRACTIBOX

SINGLE CONTAINERS



■ 96 - compartments ■ 01 - containers

ORD. NO.	DIM. mm
F PG 1071 01 01	600x69x77 h
Container with 9 compartments	



■ 96 - compartments ■ 01 - containers

ORD. NO.	DIM. mm
F PG 1571 01 01	600x98x112 h
Container with 6 compartments	



■ 96 - compartments ■ 01 - containers

ORD. NO.	DIM. mm
F PG 2071 01 01	600x141x164 h
Container with 5 compartments	



■ 96 - compartments ■ 01 - containers

ORD. NO.	DIM. mm
F PG 2571 01 01	600x174x206 h
Container with 4 compartments	



■ 96 - compartments ■ 01 - containers

ORD. NO.	DIM. mm
F PG 3071 01 01	600x209x240 h
Container with 3 compartments	



■ 96 - compartments ■ 01 - containers

ORD. NO.	DIM. mm
F PG 3571 01 01	600x311x353 h
Container with 2 compartments	

BENCH DISPENSER



■ 01

ORD. NO.	DIM. mm
F PG 0320 00 01	610x150x500 h
Realized in steel	



■ 96 - compartments ■ 01 - containers

ORD. NO.	DIM. mm
F PG 0320 01 01	610x189,5x500 h
Including practibox containers	1 ORD. NO. F PG 1571 01 01 1 ORD. NO. F PG 2071 01 01 1 ORD. NO. F PG 2571 01 01



■ INFO

COLOUR OF CONTAINERS
RAL 7000 F.....01

COLOUR OF COMPARTMENTS
TRANSPARENT F.....96



www.famispa.com



PS compartments



ABS container structure



SERIES STORAGE PRACTIBOX

WALL SHELVING



■ 01

ORD. NO.**F PG 0410 00 01**Dim. mm **600x28x300 h**

Made from painted sheet steel



■ 96 - compartments ■ 01 - containers

ORD. NO.

DIM. mm

F PG 0410 01 01 600x78x308 h

Including: 4 ORD. NO. F PG 1071 01 01



■ 96 - compartments ■ 01 - containers

ORD. NO.

DIM. mm

F PG 0410 02 01 600x107x300 hIncluding: 1 ORD. NO. F PG 1071 01 01
2 ORD. NO. F PG 1571 01 01

■ 96 - compartments ■ 01 - containers

ORD. NO.

DIM. mm

F PG 0410 03 01 600x150x328 h

Including: 2 ORD. NO. F PG 2071 01 01



■ 01

ORD. NO.**F PG 0420 00 01**Dim. mm **600x28x500 h**

Made from painted sheet steel



■ 96 - compartments ■ 01 - containers

ORD. NO.

DIM. mm

F PG 0420 01 01 600x78x500 h

Including: 6 ORD. NO. F PG 1071 01 01



■ 96 - compartments ■ 01 - containers

ORD. NO.

DIM. mm

F PG 0420 02 01 600x107x500 hIncluding: 2 ORD. NO. F PG 1071 01 01
3 ORD. NO. F PG 1571 01 01

■ 96 - compartments ■ 01 - containers

ORD. NO.

DIM. mm

F PG 0420 03 01 600x183x500 hIncluding: 1 ORD. NO. F PG 1571 01 01
1 ORD. NO. F PG 2071 01 01
1 ORD. NO. F PG 2571 01 01

■ 01

ORD. NO.**F PG 0430 00 01**Dim. mm **600x28x650 h**

Made from painted sheet steel



■ 96 - compartments ■ 01 - containers

ORD. NO.

DIM. mm

F PG 0430 01 01 600x150x664 hIncluding: 3 ORD. NO. F PG 1571 01 01
2 ORD. NO. F PG 2071 01 01

■ 96 - compartments ■ 01 - containers

ORD. NO.

DIM. mm

F PG 0430 02 01 600x107x650 hIncluding: 1 ORD. NO. F PG 1071 01 01
5 ORD. NO. F PG 1571 01 01

■ 96 - compartments ■ 01 - containers

ORD. NO.

DIM. mm

F PG 0430 03 01 600x78x650 h

Including: 8 ORD. NO. F PG 1071 01 01



Wall fixing system with grips and fixing of the Practibox containers to shelving system.

COLOUR OF CONTAINERS
RAL 7000 F.01COLOUR OF COMPARTMENTS
TRANSPARENT F.96

INFO ■

ABS
container structurePS
compartments
www.famispa.com

LENGTH = 600 mm

SERIES STORAGE PRACTIBOX



01

ORD. NO.

F PG 0530 00 01

Dim. mm **600x41x1000 h**

Made from painted sheet steel



96 - compartments 01 - containers

ORD. NO.

DIM. mm

F PG 0530 02 01 600x113x1008 h

Including 9 ORD. NO. F PG 1571 01 01



96 - compartments 01 - containers

ORD. NO.

DIM. mm

F PG 0530 03 01 600x224x1000 h

Including: 2 ORD. NO. F PG 1571 01 01
2 ORD. NO. F PG 2071 01 01
1 ORD. NO. F PG 2571 01 01
1 ORD. NO. F PG 3071 01 01



96 - compartments 01 - containers

ORD. NO.

DIM. mm

F PG 0530 04 01 600x113x1022 h

Including: 6 ORD. NO. F PG 1071 01 01
5 ORD. NO. F PG 1571 01 01



01

ORD. NO.

F PG 0540 00 01

Dim. mm **600x41x1500 h**

Made from painted sheet steel



96 - compartments 01 - containers

ORD. NO.

DIM. mm

F PG 0540 01 01 600x113x1500 h

Including: 9 ORD. NO. F PG 1071 01 01
7 ORD. NO. F PG 1571 01 01

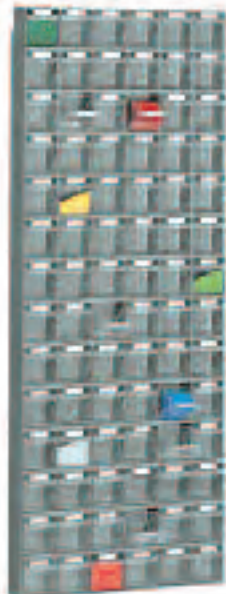

96 - compartments 01 - containers

ORD. NO.

DIM. mm

F PG 0540 02 01 600x113x1568 h

Including: 14 ORD. NO. F PG 1571 01 01



96 - compartments 01 - containers

ORD. NO.

DIM. mm

F PG 0540 03 01 600x224x1540 h

Including: 2 ORD. NO. F PG 1071 01 01
4 ORD. NO. F PG 1571 01 01
3 ORD. NO. F PG 2071 01 01
1 ORD. NO. F PG 2571 01 01
1 ORD. NO. F PG 3071 01 01



INFO

COLOUR OF CONTAINERS
RAL 7000 F.....01

COLOUR OF COMPARTMENTS
TRANSPARENT F.....96



www.famispaspa.com



PS
compartments



ABS
container structure

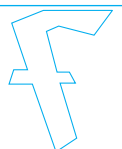

SERIES STORAGE PRACTIBOX



■ 01

ORD. NO.**F PG 0550 00 01**Dim. mm **600x41x1750 h**Made from painted
sheet steel

■ 96 - compartments ■ 01 - containers

ORD. NO.

DIM. mm

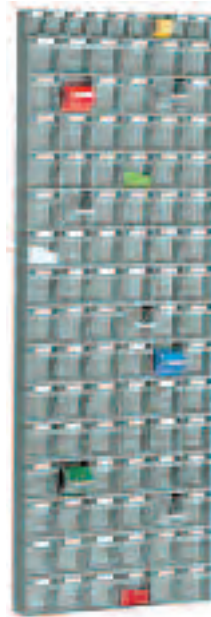
F PG 0550 01 01 600x113x1750 hIncluding: 8 ORD. NO. F PG 1071 01 01
10 ORD. NO. F PG 1571 01 01

■ 96 - compartments ■ 01 - containers

ORD. NO.

DIM. mm

F PG 0550 02 01 600x113x1757 hIncluding: 1 ORD. NO. F PG 1071 01 01
15 ORD. NO. F PG 1571 01 01

■ 96 - compartments ■ 01 - containers

ORD. NO.

DIM. mm

F PG 0550 03 01 600x224x1750 hIncluding: 1 ORD. NO. F PG 1071 01 01
6 ORD. NO. F PG 1571 01 01
2 ORD. NO. F PG 2071 01 01
2 ORD. NO. F PG 2571 01 01
1 ORD. NO. F PG 3071 01 01

■ 01

ORD. NO.**F PG 0560 00 01**Dim. mm **600x41x1950 h**Made from painted
sheet steel

■ 96 - compartments ■ 01 - containers

ORD. NO.

DIM. mm

F PG 0560 01 01 600x113x1960 hIncluding: 8 ORD. NO. F PG 1071 01 01
12 ORD. NO. F PG 1571 01 01

■ 96 - compartments ■ 01 - containers

ORD. NO.

DIM. mm

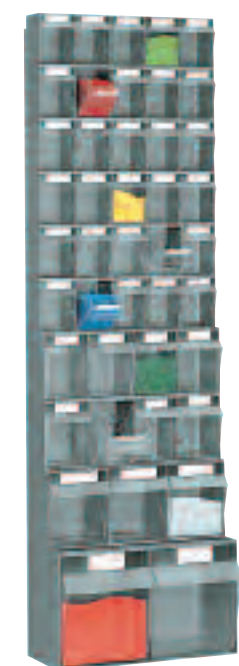
F PG 0560 02 01 600x156x1950 hIncluding: 3 ORD. NO. F PG 1071 01 01
8 ORD. NO. F PG 1571 01 01
5 ORD. NO. F PG 2071 01 01

■ 96 - compartments ■ 01 - containers

ORD. NO.

DIM. mm

F PG 0560 03 01 600x326x1989 hIncluding: 6 ORD. NO. F PG 2071 01 01
2 ORD. NO. F PG 2571 01 01
1 ORD. NO. F PG 3071 01 01
1 ORD. NO. F PG 3571 01 01COLOUR OF CONTAINERS
RAL 7000 F.01COLOUR OF COMPARTMENTS
TRANSPARENT F.96

INFO ■

www.famispa.com

LENGTH = 600 mm

SERIES STORAGE PRACTIBOX

SHELVING WITH BASE



■ 01

ORD. NO.**F PG 0640 00 01**Dim. mm **600x325x1500 h**

Stacking height 1400 mm

Made from painted sheet steel



■ 96 - compartments ■ 01 - containers

ORD. NO.

DIM. mm

F PG 0640 01 01 600x325x1500 hIncluding: 8 ORD. NO. F PG 1071 01 01
7 ORD. NO. F PG 1571 01 01

■ 96 - compartments ■ 01 - containers

ORD. NO.

DIM. mm

F PG 0640 02 01 600x325x1556 h

Including: 13 ORD. NO. F PG 1571 01 01



■ 96 - compartments ■ 01 - containers

ORD. NO.

DIM. mm

F PG 0640 03 01 600x325x1528 hIncluding: 2 ORD. NO. F PG 1071 01 01
3 ORD. NO. F PG 1571 01 01
3 ORD. NO. F PG 2071 01 01
1 ORD. NO. F PG 2571 01 01
1 ORD. NO. F PG 3071 01 01

■ 01

ORD. NO.**F PG 0650 00 01**Dim. mm **600x325x1750 h**

Stacking height 1650 mm

Made from painted sheet steel

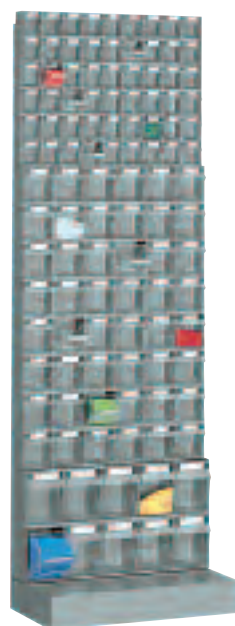

■ 96 - compartments ■ 01 - containers

ORD. NO.

DIM. mm

F PG 0650 02 01 600x325x1786 hIncluding: 6 ORD. NO. F PG 1071 01 01
8 ORD. NO. F PG 1571 01 01
2 ORD. NO. F PG 2071 01 01

■ 96 - compartments ■ 01 - containers

ORD. NO.

DIM. mm

F PG 0650 03 01 600x325x1750 hIncluding: 2 ORD. NO. F PG 1071 01 01
3 ORD. NO. F PG 1571 01 01
3 ORD. NO. F PG 2071 01 01
2 ORD. NO. F PG 2571 01 01
1 ORD. NO. F PG 3071 01 01

■ 96 - compartments ■ 01 - containers

ORD. NO.

DIM. mm

F PG 0650 04 01 600x325x1770 hIncluding: 5 ORD. NO. F PG 1571 01 01
3 ORD. NO. F PG 2071 01 01
3 ORD. NO. F PG 2571 01 01

■ INFO

**BASE****ORD. NO. F PG 0610 00 01**Dimensions mm **600x300x100 h**
Made from painted sheet steel

■ 01

PS
compartmentsABS
container structureCOLOUR OF CONTAINERS
RAL 7000 F. 01COLOUR OF COMPARTMENTS
TRANSPARENT F. 96

SERIES STORAGE PRACTIBOX

SHELVING WITH BASE



■ 01

ORD. NO.**F PG 0660 00 01**Dim. mm **600x325x1950 h**

Stacking height 1850 mm

Made from painted
sheet steel

■ 96 - compartments ■ 01 - containers

ORD. NO.

DIM. mm

F PG 0660 01 01 600x325x1950 hIncluding: 6 ORD. NO. F PG 1071 01 01
9 ORD. NO. F PG 1571 01 01
1 ORD. NO. F PG 2071 01 01
1 ORD. NO. F PG 2571 01 01

■ 96 - compartments ■ 01 - containers

ORD. NO.

DIM. mm

F PG 0660 02 01 600x325x1950 hIncluding: 2 ORD. NO. F PG 1071 01 01
3 ORD. NO. F PG 1571 01 01
3 ORD. NO. F PG 2071 01 01
3 ORD. NO. F PG 2571 01 01
1 ORD. NO. F PG 3071 01 01

■ 96 - compartments ■ 01 - containers

ORD. NO.

DIM. mm

F PG 0660 03 01 600x325x1976 hIncluding: 5 ORD. NO. F PG 1571 01 01
3 ORD. NO. F PG 2071 01 01
4 ORD. NO. F PG 2571 01 01

LABELS

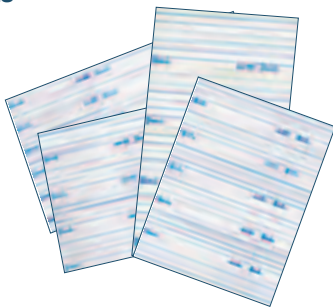
**ORD. NO.**

FOR CONTAINERS ORD. NO.

F PG 9020 00 00 F PG 1071 01 01**F PG 9040 00 00** F PG 1571 01 01**F PG 9060 00 00** F PG 2071 01 01**F PG 9080 00 00** F PG 2571 01 01**F PG 9100 00 00** F PG 3071 01 01**F PG 9120 00 00** F PG 3571 01 01

LOCKING BARS FOR CONTAINERS



■ 99

ORD. NO.

FOR CONTAINER ORD. NO.

F PG 0910 00 99 F PG 1071 01 01**F PG 0915 00 99** F PG 1571 01 01**F PG 0920 00 99** F PG 2071 01 01**F PG 0925 00 99** F PG 2571 01 01**F PG 0930 00 99** F PG 3071 01 01**F PG 0935 00 99** F PG 3571 01 01

locking system

COLOUR OF CONTAINERS
RAL 7000 F.....01COLOUR OF COMPARTMENTS
TRANSPARENT F.....96GALVANISED
F.....99

INFO ■

www.famispa.com

LENGTH =750 mm

SERIES STORAGE PRACTIBOX

CONTAINER TROLLEY



Front



Rear

■ 01

ORD. NO.

F PG 0121 00 01

Dim. mm 750x660x1420 h

Stacking height 1200 mm

Trolley without Practibox

TOOL-TRAY



■ 01

ORD. NO.

F PG 0190 00 01

Dim. mm 600x220x110 h



■ Trolleys series SMART see page D2

TOP-BOX CASE



■ 96 - compartments ■ 04 - containers

ORD. NO.

F PG 5561 01 04

DIM. mm

350x200x465 h

Complete with 18 compartments

ROTARY TOWER FOR PRACTIBOX CONTAINERS



■ 96 - compartments
■ 01 - containers

■ The rotary tower must be fixed to the floor



ORD. NO.

F PG 0226 01 01

WITH 4 FRAMES ORD. NO.

F PG 0550 00 01

Including:

2 ORD. NO. F PG 1071 01 01

18 ORD. NO. F PG 1571 01 01

22 ORD. NO. F PG 2071 01 01

6 ORD. NO. F PG 2571 01 01

■ INFO

COLOUR OF CONTAINERS
RAL 7000 F.01

COLOUR OF COMPARTMENTS
TRANSPARENT F.96



www.famispa.com



PS
compartments



ABS
container structure

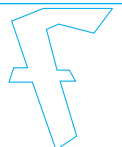

SERIES STORAGE PRACTIBOX

- VERTICAL SYSTEM
- LOAD CAPACITY **100 KG PER DRAWER**

■ These cupboards, standard supplied with a single drawer opening device, **MUST BE FIXED** to the floor or wall. The floor-fixing material, if required, can be supplied by **FAMI**.

■ ORD. NO. F SR 8999 00 99

Fixing material including 2 steel floor bolts M8x75 mm for uninterrupted concrete floors equal to or higher than class: B25 / RBK250 / MP_A 25N for mm².



DIMENSIONS mm: 1073x705x2000 h. USABLE WIDTH mm: 967

DIMENSIONS mm: 1481x705x2000 h. USABLE WIDTH mm: 1375

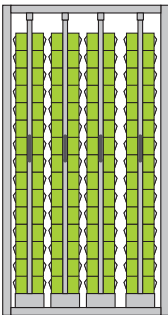

ORD. NO. ■ 01

F PG 0035 01 01 With lock
F PG 0030 01 01 Without lock
with 4 compartments without Practibox

ORD. NO. ■ 01

F PG 0035 51 01 With lock
F PG 0030 51 01 Without lock
with 4 compartments complete of:
120 ORD. NO. F PG 1571 01 01

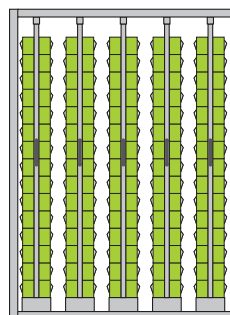

ORD. NO. ■ 01

F PG 0055 01 01 With lock
F PG 0050 01 01 Without lock
with 5 compartments without Practibox

ORD. NO. ■ 01

F PG 0055 51 01 With lock
F PG 0050 51 01 Without lock
with 5 compartments complete of:
150 ORD. NO. F PG 1571 01 01

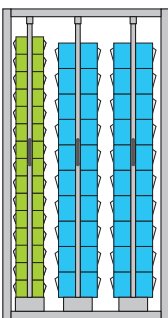

ORD. NO. ■ 01

F PG 0035 02 01 With lock
F PG 0030 02 01 Without lock
with 3 compartments without Practibox

ORD. NO. ■ 01

F PG 0035 52 01 With lock
F PG 0030 52 01 Without lock
with 3 compartments complete of:
30 ORD. NO. F PG 1571 01 01
40 ORD. NO. F PG 2071 01 01

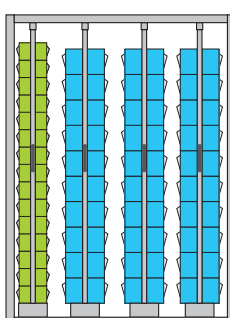

ORD. NO. ■ 01

F PG 0055 02 01 With lock
F PG 0050 02 01 Without lock
with 4 compartments without Practibox

ORD. NO. ■ 01

F PG 0055 52 01 With lock
F PG 0050 52 01 Without lock
with 4 compartments complete of:
30 ORD. NO. F PG 1571 01 01
60 ORD. NO. F PG 2071 01 01

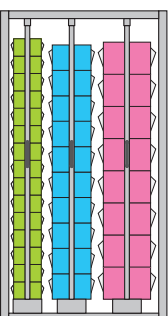

ORD. NO. ■ 01

F PG 0035 03 01 With lock
F PG 0030 03 01 Without lock
with 3 compartments without Practibox

ORD. NO. ■ 01

F PG 0035 53 01 With lock
F PG 0030 53 01 Without lock
with 3 compartments complete of:
30 ORD. NO. F PG 1571 01 01
20 ORD. NO. F PG 2071 01 01
16 ORD. NO. F PG 2571 01 01

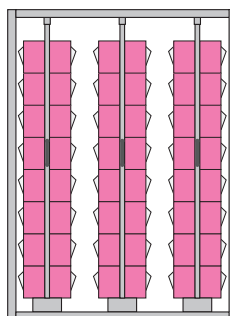

ORD. NO. ■ 01

F PG 0055 03 01 With lock
F PG 0050 03 01 Without lock
with 3 compartments without Practibox

ORD. NO. ■ 01

F PG 0055 53 01 With lock
F PG 0050 53 01 Without lock
with 3 compartments complete of:
48 ORD. NO. F PG 2571 01 01

DIMENSIONS = 1073/1481x705x2000 mm

SERIES STORAGE PRACTIBOX



- VERTICAL SYSTEM
- LOAD CAPACITY 400 KG PER DRAWER

■ These cupboards, standard supplied with a single drawer opening device, **MUST BE FIXED** to the floor or wall. The floor-fixing material, if required, can be supplied by FAMI.

■ ORD. NO. F SR 8999 00 99
Fixing material including 2 steel floor bolts M8x75 mm for uninterrupted concrete floors equal to or higher than class: B25 / RBK250 / MP_A 25N for mm².

DIMENSIONS mm: 1073x705x2000 h. USABLE WIDTH mm: 967

DIMENSIONS mm: 1481x705x2000 h. USABLE WIDTH mm: 1375

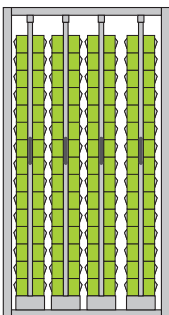

ORD. NO. ■ 01
F PG 0036 01 01 With lock
F PG 0031 01 01 Without lock
with 4 compartments without Practibox

ORD. NO. ■ 01
F PG 0036 51 01 With lock
F PG 0031 51 01 Without lock
with 4 compartments complete of:
120 ORD. NO. F PG 1571 01 01

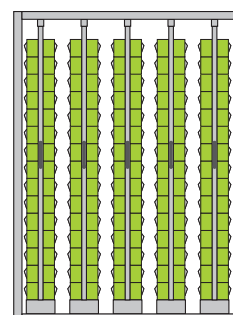

ORD. NO. ■ 01
F PG 0056 01 01 With lock
F PG 0051 01 01 Without lock
with 5 compartments without Practibox

ORD. NO. ■ 01
F PG 0056 51 01 With lock
F PG 0051 51 01 Without lock
with 5 compartments complete of:
150 ORD. NO. F PG 1571 01 01

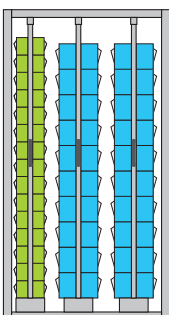

ORD. NO. ■ 01
F PG 0036 02 01 With lock
F PG 0031 02 01 Without lock
with 3 compartments without Practibox

ORD. NO. ■ 01
F PG 0036 52 01 With lock
F PG 0031 52 01 Without lock
with 3 compartments complete of:
30 ORD. NO. F PG 1571 01 01
40 ORD. NO. F PG 2071 01 01

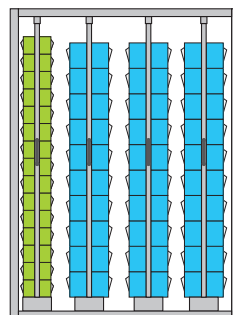

ORD. NO. ■ 01
F PG 0056 02 01 With lock
F PG 0051 02 01 Without lock
with 4 compartments without Practibox

ORD. NO. ■ 01
F PG 0056 52 01 With lock
F PG 0051 52 01 Without lock
with 4 compartments complete of:
30 ORD. NO. F PG 1571 01 01
60 ORD. NO. F PG 2071 01 01

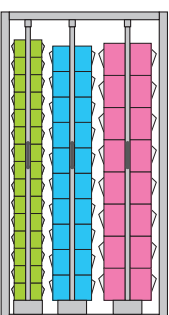

ORD. NO. ■ 01
F PG 0036 03 01 With lock
F PG 0031 03 01 Without lock
with 3 compartments without Practibox

ORD. NO. ■ 01
F PG 0036 53 01 With lock
F PG 0031 53 01 Without lock
with 3 compartments complete of:
30 ORD. NO. F PG 1571 01 01
20 ORD. NO. F PG 2071 01 01
16 ORD. NO. F PG 2571 01 01

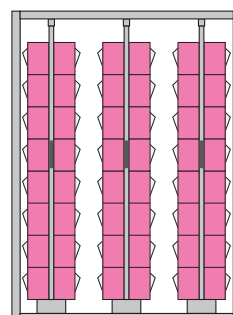

ORD. NO. ■ 01
F PG 0056 03 01 With lock
F PG 0051 03 01 Without lock
with 3 compartments without Practibox

ORD. NO. ■ 01
F PG 0056 53 01 With lock
F PG 0051 53 01 Without lock
with 3 compartments complete of:
48 ORD. NO. F PG 2571 01 01

SERIES STORAGE GOLD BOX



Sliding lid with click closing



The lid can be fastened with a security seal



■ 01



■ 01



■ 01

ORD. NO.

DIM. mm

F PH 3651 AC 01 227x180x100 h

External dim. mm 227x180x100 h

Useful dim. mm 187x136x93 h

Capacity litres 3

Weight gr. 426

Standard colour ■

Bottom **solid**Long sides **closed**Short sides **closed****ORD. NO.**

DIM. mm

F PH 4851 AC 01 336x231x100 h

External dim. mm 336x231x100 h

Useful dim. mm 282x178x90 h

Capacity litres 5

Weight gr. 716

Standard colour ■

Bottom **solid**Long sides **closed**Short sides **closed****ORD. NO.**

DIM. mm

F PH 5251 AC 01 336x231x150 h

External dim. mm 336x231x150 h

Useful dim. mm 285x179x144 h

Capacity litres 8

Weight gr. 818

Standard colour ■

Bottom **solid**Long sides **closed**Short sides **closed**GREY
F.....01**KEY ■**

The containers marked with this symbol can be used to store food-stuffs.



Containers with this symbol are made of completely recyclable plastic material.



STORAGE SECURITY



■ 04

ORD. NO. DIM. mm

F PH CB51 00 04 147x98x53 h

External dim. mm 147x98x53 h

Useful dim. mm 128x78x45 h

Capacity litres -

Weight gr. 124

Standard colour ■

To open the lid push
the central part■ Lid with click closing **CAN NOT BE REUTILIZED**

STORAGE SHELL



■ 04

ORD. NO. DIM. mm

F PH 0C51 00 04 148x110x28 h

External dim. mm 148x110x28 h

Useful dim. mm 124x83x20 h

Capacity litres -

Weight gr. 66

Standard colour ■

Hinged lid with click
closing. The lid can be
fastened with a security
seal.

■ KEY

BLUE
F.....04

Containers with this symbol are made of completely recyclable plastic material.



PP



SERIES STORAGE SYSTEM TR

- AVAILABLE IN 2 DIFFERENT HEIGHTS
- FOR STACKING AND STORAGE CONTAINERS



■ 99



Upper shelf galvanised or painted



Cross bracing galvanised



Pair of guides galvanised



■ 99



Foot galvanised

GALVANISED
F. 99

INFO ■

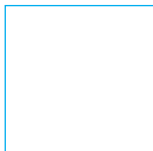
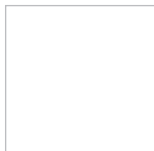
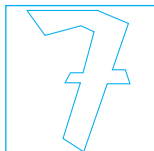

www.famispa.com





99

FIXING SET



Fixing material including 2 steel floor bolts M8x75 mm for uninterrupted concrete floors equal to or higher than class: B25 / RBK250 / MP, 25N for mm².

ORD. NO. F NC 8999 00 99

- The uprights are fixed to the floor with expansion grip.



99

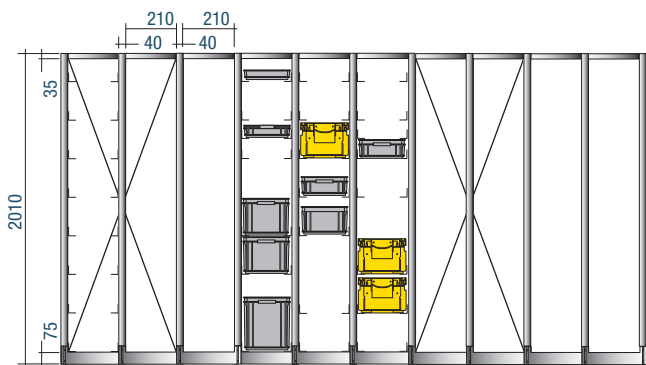

shelving system depth 300 mm



- The cross bracings are made from galvanised sheet metal. One cross bracing must be fitted every 6 bays to ensure that the shelving system 2000 mm h remains stable.

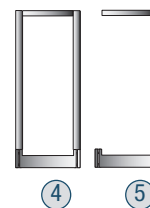
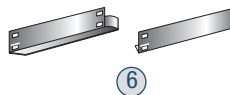
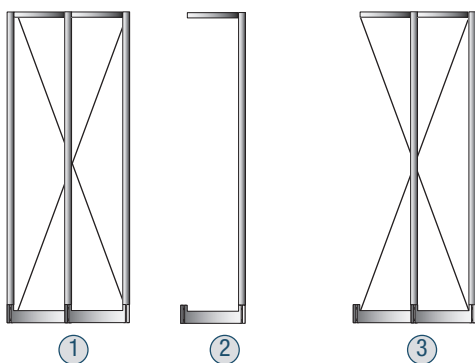
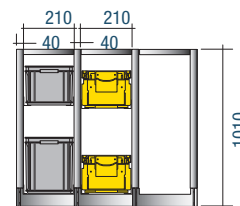

ORD. NO.

TYPE OF BAY
mm

LOAD CAPACITY
PER BAY kg

F TR D200 30 99	① Double unit with cross bracing 2010 h	250
F TR E200 30 99	② Add-on single unit 2010 h	250
F TR F200 30 99	③ Add-on double unit with cross bracing 2010 h	250
F TR G100 30 99	④ Single unit 1010 h	250
F TR E100 30 99	⑤ Add-on single unit 1010 h	250
F TR 9000 00 99	⑥ Pair of galvanised guide rails	50

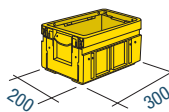
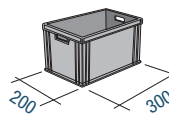

FOR CONTAINERS
DIM. mm

MINIMUM DISTANCE
OF GUIDE RAILS mm

300x200x120 h	150
300x200x170 h	200
300x200x147,5 h	175

■ **INFO**



www.famispa.com

GALVANISED
F. 99



SERIES STORAGE SYSTEM TR

SHELVING SYSTEM SERIES **F TR** FOR CONTAINERS **300x400**



■ 99

FIXING SET



Fixing material including 2 steel floor bolts M8x75 mm for uninterrupted concrete floors equal to or higher than class: B25 / RBK250 / MP_a 25N for mm².

ORD. NO. F NC 8999 00 99

■ The uprights are fixed to the floor with expansion grip.



■ 99

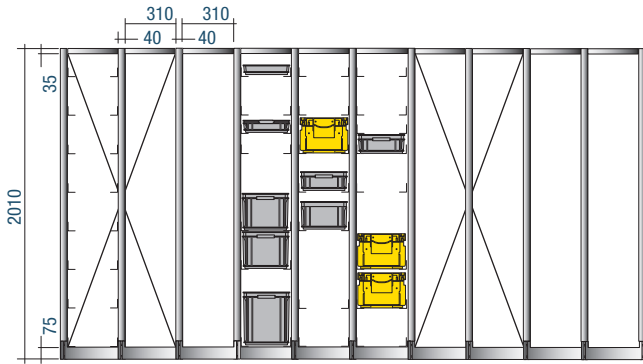

shelving system depth 400 mm



■ The cross bracings are made from galvanised sheet metal. One cross bracing must be fitted every 6 bays to ensure that the shelving system 2000 mm h remains stable.

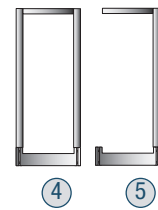
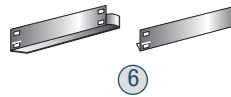
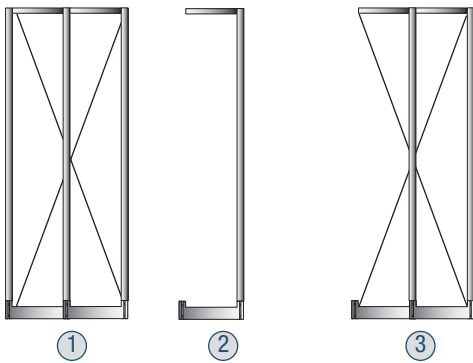
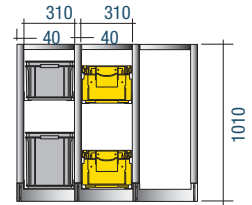

ORD. NO.	TYPE OF BAY mm	LOAD CAPACITY PER BAY kg
F TR D200 40 99	① Double unit with cross bracing 2010 h	250
F TR E200 40 99	② Add-on single unit 2010 h	250
F TR F200 40 99	③ Add-on double unit with cross bracing 2010 h	250
F TR G100 40 99	④ Single unit 1010 h	250
F TR E100 40 99	⑤ Add-on single unit 1010 h	250
F TR 9040 00 99	⑥ Pair of galvanised guide rails	50

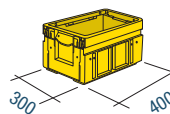
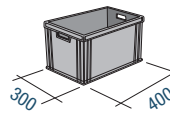

FOR CONTAINERS DIM. mm	MINIMUM DISTANCE OF GUIDE RAILS mm
400x300x55 h	75
400x300x78 h	100
400x300x120 h	150
400x300x170 h	200
400x300x220 h	250
400x300x325 h	350

GALVANISED
F. 99

INFO ■





FIXING SET



Fixing material including 2 steel floor bolts M8x75 mm for uninterrupted concrete floors equal to or higher than class: B25 / RBK250 / MP_a 25N for mm².

ORD. NO. F NC 8999 00 99

■ The uprights are fixed to the floor with expansion grip.

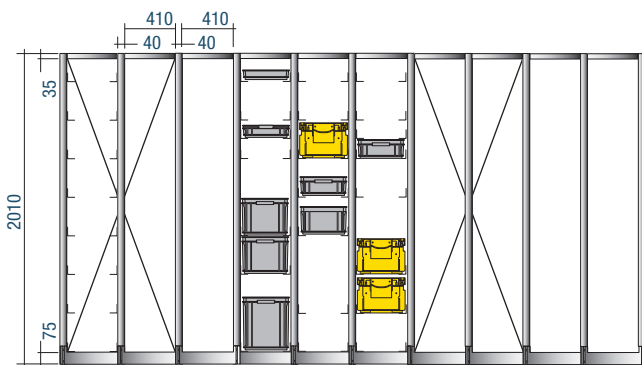

shelving system depth 600 mm



■ The cross bracings are made from galvanised sheet metal. One cross bracing must be fitted every 6 bays to ensure that the shelving system 2000 mm h remains stable.

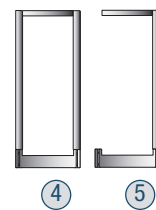
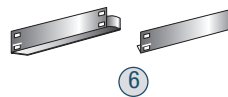
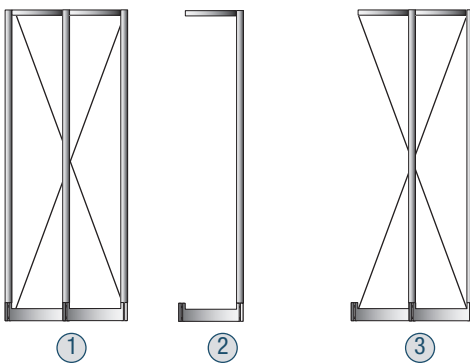
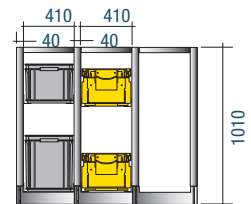

ORD. NO.

TYPE OF BAY
mm

LOAD CAPACITY
PER BAY kg

F TR D200 60 99	① Double unit with cross bracing 2010 h	250
F TR E200 60 99	② Add-on single unit 2010 h	250
F TR F200 60 99	③ Add-on double unit with cross bracing 2010 h	250
F TR G100 60 99	④ Single unit 1010 h	250
F TR E100 60 99	⑤ Add-on single unit 1010 h	250
F TR 9080 00 99	⑥ Pair of galvanised guide rails	50

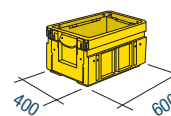
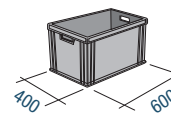

FOR CONTAINERS
DIM. mm

MINIMUM DISTANCE
OF GUIDE RAILS mm

600x400x78 h	100
600x400x120 h	150
600x400x170 h	200
600x400x220 h	250
600x400x285 h	325
600x400x325 h	350
600x400x430 h	450

■ **INFO**

GALVANISED
F. 99



www.famispas.com

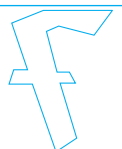

SERIES STORAGE SYSTEM TR

SHELVING SYSTEM SERIES F TR 223x350 FOR CONTAINERS SIZE 3A2/3



FIXING SET



Fixing material including 2 steel floor bolts M8x75 mm for uninterrupted concrete floors equal to or higher than class: B25 / RBK250 / MPa 25N for mm².

ORD. NO. F NC 8999 00 99

■ The uprights are fixed to the floor with expansion grip.

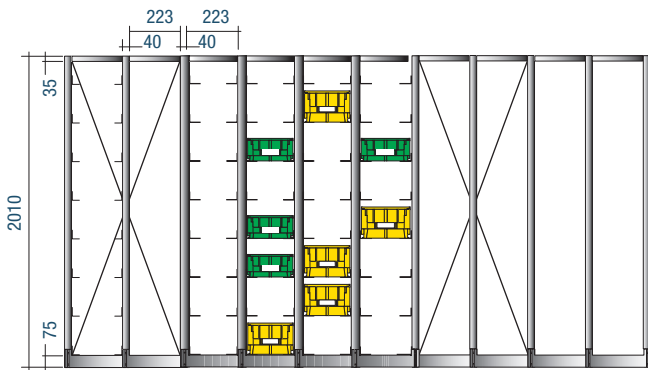

shelving system depth 350 mm



■ The cross bracings are made from galvanised sheet metal. One cross bracing must be fitted every 6 bays to ensure that the shelving system 2000 mm h remains stable.

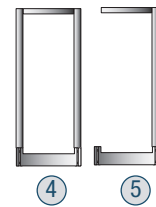
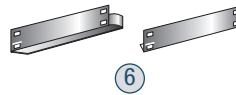
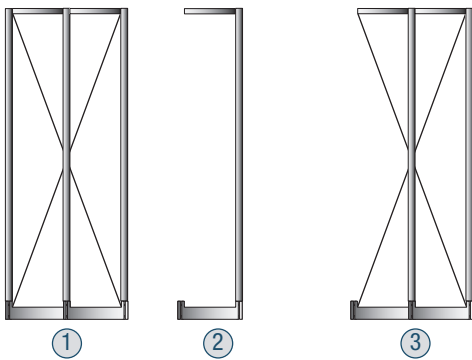
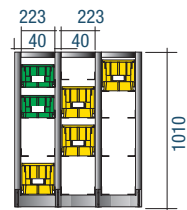

ORD. NO.	TYPE OF BAY mm	LOAD CAPACITY PER BAY kg
F TR D200 35 99	① Double unit with cross bracing 2010 h	250
F TR E200 35 99	② Add-on single unit 2010 h	250
F TR F200 35 99	③ Add-on double unit with cross bracing 2010 h	250
F TR G100 35 99	④ Single unit 1010 h	250
F TR E100 35 99	⑤ Add-on single unit 1010 h	250
F TR 9020 00 99	⑥ Pair of galvanised guide rails	50

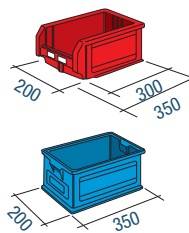

FOR CONTAINERS SIZE	MINIMUM DISTANCE OF GUIDE RAILS mm
3A2	175
3	225
272-3A2	175
272-3	225

GALVANISED F. 99

INFO ■



SHELVING SYSTEM SERIES **F TR 323x500** FOR CONTAINERS SIZE 4/4A2/4A5



99

FIXING SET



Fixing material including 2 steel floor bolts M8x75 mm for uninterrupted concrete floors equal to or higher than class: B25 / RBK250 / MPa. 25N for mm².

ORD. NO. F NC 8999 00 99

■ The uprights are fixed to the floor with expansion grip.



99

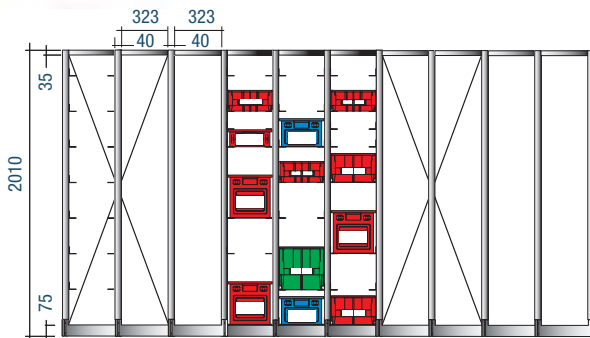

shelving system depth 500 mm



■ The cross bracings are made from galvanised sheet metal. One cross bracing must be fitted every 6 bays to ensure that the shelving system 2000 mm h remains stable.

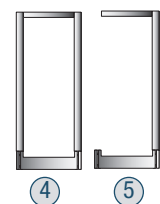
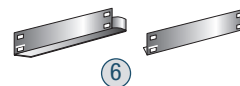
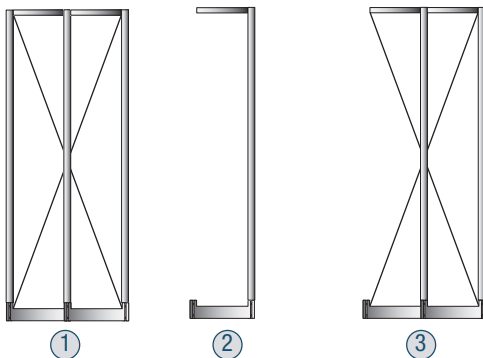
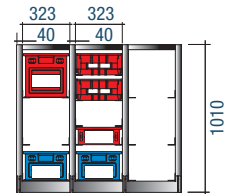

ORD. NO.	TYPE OF BAY mm	LOAD CAPACITY PER BAY kg
F TR D200 50 99	① Double unit with cross bracing 2010 h	250
F TR E200 50 99	② Add-on single unit 2010 h	250
F TR F200 50 99	③ Add-on double unit with cross bracing 2010 h	250
F TR G100 50 99	④ Single unit 1010 h	250
F TR E100 50 99	⑤ Add-on single unit 1010 h	250
F TR 9060 00 99	⑥ Pair of galvanised guide rails	50

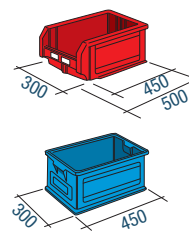

FOR CONTAINERS SIZE	MINIMUM DISTANCE OF GUIDE RAILS mm
272-4A2	150
272-4	225
272-4A5	325
4A2	200
4	225
4A5	325

■ **INFO**

GALVANISED F. 99



www.famispa.com

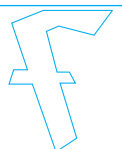

SERIES STORAGE DOMINO

■ FOR PLASTIC AND STEEL CONTAINERS

■ STACKABLE

■ The shelving system must be fixed to the floor and/or to the wall.

Handy work stations for distributing the materials can be obtained by connecting accessories (base plinths, work top and dust cover) to the shelf units.



Each container can be removed quickly and easily and a special hook fitted to the shelf unit prevents the container from accidentally falling out.



detail of hook

SHELVING UNITS SERIES **F ED 3044**



■ 01

■ Shelving unit **without** containers



size 3
Containers:
see page from
G28 to G41

STACKABLE

ORD. NO. SHELVING	Stacked units	Load capacity for each unit	Load capacity for each box
F ED 3044 00 01	2 max 3	960 kg 640 kg	60 kg 40 kg

ORD. NO.	DIM. mm
F ED 3044 00 01	1025x310x885 h

Max q.ty of stacking containers which can be fitted: **16 pcs size 3**

ORD. NO.	DIM. mm
F ED 9034 00 01	1020x315x20 h

Dust cover. For shelving ORD. NO. F ED 3044 00 01

ORD. NO.	DIM. mm
F ED 9134 00 01	1025x315x32 h

Work top. For shelving ORD. NO. F ED 3044 00 01

ORD. NO.	DIM. mm
F ED 9234 00 01	1020x315x85 h

Base plinth. For shelving ORD. NO. F ED 3044 00 01

SHELVING UNITS SERIES **F ED 3074**

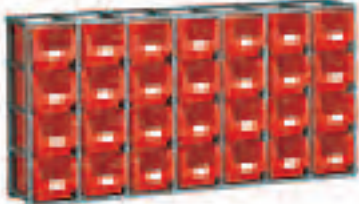

■ 01

■ Shelving unit **without** containers



size 3
Containers:
see page from
G28 to G41

STACKABLE

ORD. NO. SHELVING	Stacked units	Load capacity for each unit	Load capacity for each box
F ED 3074 00 01	2 max 3	1680 kg 1120 kg	60 kg 40 kg

ORD. NO.	DIM. mm
F ED 3074 00 01	1765x310x885 h

Max q.ty of stacking containers which can be fitted: **28 pcs size 3**

ORD. NO.	DIM. mm
F ED 9037 00 01	1765x315x20 h

Dust cover. For shelving ORD. NO. F ED 3074 00 01

ORD. NO.	DIM. mm
F ED 9137 00 01	1770x315x32 h

Work top. For shelving ORD. NO. F ED 3074 00 01

ORD. NO.	DIM. mm
F ED 9237 00 01	1765x315x85 h

Base plinth. For shelving ORD. NO. F ED 3074 00 01

RAL 7000
F.....01

INFO ■



FOR PLASTIC AND STEEL CONTAINERS

SERIES STORAGE DOMINO

SHELVING UNITS SERIES F ED 4034



■ 01

■ Shelving unit **without** containers

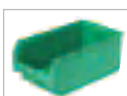

size 4
Containers:
see page from
G28 to G41

STACKABLE

ORD. NO. SHELVING	Stacked units	Load capacity for each unit	Load capacity for each box
F ED 4034 00 01	max 3	1200 kg	100 kg

ORD. NO. DIM. mm

F ED 4034 00 01 1075x460x885 h

Max q.ty of stacking containers which can be fitted: **12 pcs size 4**



■ 01

ORD. NO. DIM. mm

F ED 9043 00 01 1070x465x20 h

Dust cover. For shelving ORD. NO. F ED 4034 00 01



■ 01

ORD. NO. DIM. mm

F ED 9143 00 01 1075x465x32 h

Work top. For shelving ORD. NO. F ED 4034 00 01



■ 01

ORD. NO. DIM. mm

F ED 9243 00 01 1070x465x85 h

Base plinth. For shelving ORD. NO. F ED 4034 00 01

SHELVING UNITS SERIES F ED 4054



■ 01

■ Shelving unit **without** containers

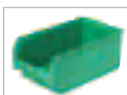

size 4
Containers:
see page from
G28 to G41

STACKABLE

ORD. NO. SHELVING	Stacked units	Load capacity for each unit	Load capacity for each box
F ED 4054 00 01	max 3	1600 kg	80 kg

ORD. NO. DIM. mm

F ED 4054 00 01 1765x460x885 h

Max q.ty of stacking containers which can be fitted: **20 pcs size 4**



■ 01

ORD. NO. DIM. mm

F ED 9045 00 01 1765x465x20 h

Dust cover
For shelving ORD. NO. F ED 4054 00 01 / F ED 4056 00 01



■ 01

ORD. NO. DIM. mm

F ED 9145 00 01 1770x465x32 h

Work top
For shelving ORD. NO. F ED 4054 00 01 / F ED 4056 00 01



■ 01

ORD. NO. DIM. mm

F ED 9245 00 01 1765x465x85 h

Base plinth
For shelving ORD. NO. F ED 4054 00 01 / F ED 4056 00 01

SHELVING UNITS SERIES F ED 4056



■ 01

■ Shelving unit **without** containers

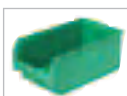

size 4
Containers:
see page from
G28 to G41

STACKABLE

ORD. NO. SHELVING	Stacked units	Load capacity for each unit	Load capacity for each box
F ED 4056 00 01	2 max 3	2400 kg 1500 kg	80 kg 50 kg

ORD. NO. DIM. mm

F ED 4056 00 01 1765x460x1300 h

Max q.ty of stacking containers which can be fitted: **30 pcs size 4**



■ 01

ORD. NO. DIM. mm

F ED 9045 00 01 1765x465x20 h

Dust cover
For shelving ORD. NO. F ED 4054 00 01 / F ED 4056 00 01



■ 01

ORD. NO. DIM. mm

F ED 9145 00 01 1770x465x32 h

Work top
For shelving ORD. NO. F ED 4054 00 01 / F ED 4056 00 01



■ 01

ORD. NO. DIM. mm

F ED 9245 00 01 1765x465x85 h

Base plinth
For shelving ORD. NO. F ED 4054 00 01 / F ED 4056 00 01

■ INFO

RAL 7000
F.....01



www.famisp.com



SERIES STORAGE DOMINO

SHELVING UNITS SERIES F ED 4555



■ 01

■ Shelving unit **without** containers



size 4A5

Containers: see page from G28 to G41

ORD. NO. DIM. mm

F ED 4555 00 01 1765x460x1300 h

Max q.ty of stacking containers which can be fitted: 20 pcs size 4A5

STACKABLE			
ORD. NO. SHELVING	Stacked units	Load capacity for each unit	Load capacity for each box
F ED 4555 00 01	2 max 3	1600 kg 1000 kg	80 kg 50 kg



■ 01

ORD. NO. DIM. mm

F ED 9045 00 01 1765x465x20 h

Dust cover. For shelving ORD. NO. F ED 4555 00 01



■ 01

ORD. NO. DIM. mm

F ED 9145 00 01 1770x465x32 h

Work top. For shelving ORD. NO. F ED 4555 00 01



■ 01

ORD. NO. DIM. mm

F ED 9245 00 01 1765x465x85 h

Base plinth. For shelving ORD. NO. F ED 4555 00 01

SHELVING UNITS SERIES F ED 5023



■ 01

■ Shelving unit **without** containers



size 5

Containers: see page from G28 to G41

ORD. NO. DIM. mm

F ED 5023 00 01 1125x660x1180 h

Max q.ty of stacking containers which can be fitted: 6 pcs size 5

STACKABLE			
ORD. NO. SHELVING	Stacked units	Load capacity for each unit	Load capacity for each box
F ED 5023 00 01	max 3	1200 kg	200 kg



■ 01

ORD. NO. DIM. mm

F ED 9052 00 01 1120x665x30 h

Dust cover. For shelving ORD. NO. F ED 5023 00 01



■ 01

ORD. NO. DIM. mm

F ED 9352 00 01 1125x660x155 h

Base plinth. For shelving ORD. NO. F ED 5023 00 01

SHELVING UNITS SERIES F ED 5033

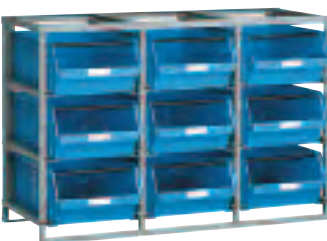

■ 01

■ Shelving unit **without** containers



size 5

Containers: see page from G28 to G41

ORD. NO. DIM. mm

F ED 5033 00 01 1670x660x1180 h

Max q.ty of stacking containers which can be fitted: 9 pcs size 5

STACKABLE			
ORD. NO. SHELVING	Stacked units	Load capacity for each unit	Load capacity for each box
F ED 5033 00 01	max 3	1800 kg	200 kg



■ 01

ORD. NO. DIM. mm

F ED 9053 00 01 1667x665x30 h

Dust cover. For shelving ORD. NO. F ED 5033 00 01



■ 01

ORD. NO. DIM. mm

F ED 9353 00 01 1670x660x155 h

Base plinth. For shelving ORD. NO. F ED 5033 00 01

RAL 7000
F.....01

INFO ■

www.famispa.com

ROTARY SAFETY LADDER FOR SHELVING UNITS STORAGE DOMINO

SERIES STORAGE DOMINO

ROTARY SAFETY LADDER FOR SHELVING UNITS STORAGE DOMINO

This ladder makes it safe and easy to reach even the containers located in the highest part of the shelf unit. Designed and produced for totally safe operation, the ladder runs along guide rails and can be open either to the right or to the left or closed in order to leave space free in the corridor. It can be locked into place with a brake that can then be released when the ladder needs to be moved again.



■ SAFETY

The level of safety of the ladder depends on the stability of the shelf system to which is fixed. For further information please ask for the technical specifications.

The shelving units can be placed one above the other in order to obtain real and proper stores with personalised horizontal and vertical layout.



30

ORD. NO. LADDER **A**

FOR SHELVING SYSTEM

F QG 2227 00 30 height of ladder 2270 mm	F ED 4054 00 01+ F ED 4056 00 01+ F ED 9245 00 01	-	-	-
F QG 2251 00 30 height of ladder 2515 mm	F ED 5023 00 01+ F ED 5023 00 01+ F ED 9352 00 01	F ED 5033 00 01+ F ED 5033 00 01+ F ED 9353 00 01+	-	-
F QG 2270 00 30 height of ladder 2685-2740 mm	F ED 3044 00 01+ F ED 3044 00 01+ F ED 3044 00 01+ F ED 9234 00 01	F ED 3074 00 01+ F ED 3074 00 01+ F ED 3074 00 01+ F ED 9237 00 01	F ED 4034 00 01+ F ED 4034 00 01+ F ED 4034 00 01+ F ED 9243 00 01	F ED 4054 00 01+ F ED 4054 00 01+ F ED 4054 00 01+ F ED 9245 00 01
F QG 2270 00 30 height of ladder 2685-2740 mm	F ED 4056 00 01+ F ED 4056 00 01+ F ED 9245 00 01	F ED 4555 00 01+ F ED 4555 00 01+ F ED 9245 00 01	-	-

GUIDE RAILS APPLICABLE TO THE SHELVING

ORD. NO. **B**

F QG 9200 00 01

Upper and lower guide rails per linear metre

N.B. The shelving system can only be stacked if the units have the same base dimensions.

- 01
- 02
- 04
- 08



opened to the left

closed

opened to the right

30

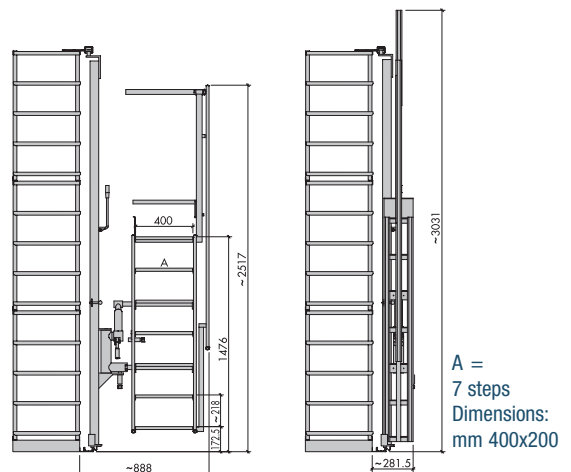

■ INFO

RAL 7000
F. 01

RAL 6011
F. 02

RAL 5012
F. 04

RAL 7035
F. 08

RAL 1004
F. 30



www.famispa.com

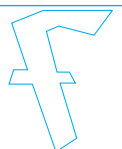

SERIES STORAGE ESD ATHENA

- SPECIAL CONDUCTIVE PLASTIC FAMI 408 L
- PARTICULARLY SUITABLE FOR THE ELECTRONICS INDUSTRY



TECHNICAL SPECIFICATIONS

Base material	Polypropylene copolymer (PPC)
Conductivity additive	Carbon black
Colour	Black
Density, at 23°C	1.04 g/cm³
Vicat softening point	154°C ISO 306
Working temperature continuous	approx 80-100°C
Working temperature short term	approx 100-120°C
Surface resistance	less than 10 ⁴ Ω cm (measured according to CEI EN 61340-2-3 at 20°C with a 5 cm² ring electrode).
Volume resistivity	10 ⁴ Ω cm (measured according to CEI EN 61340-2-3 at 20°C with a 5 cm² ring electrode)
Ageing behaviour	No deterioration of conductivity (in 7 years of service), no leaching of corrosive substances, excellent UV resistance.
Chemical resistance	Excellent (according to the generally valid PP classification)

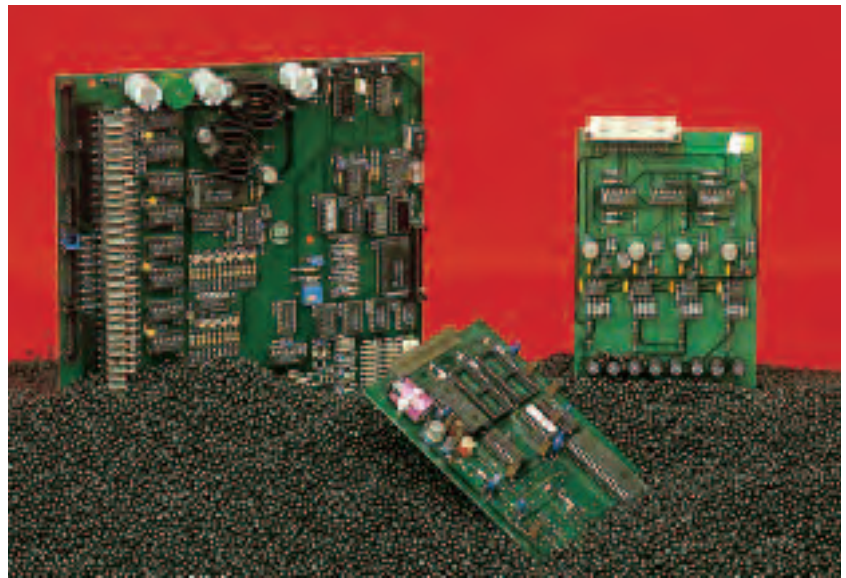

shock-resistant



fitting the hooked lid



fitting the sliding lid



CONDUCTIVITY SCALE

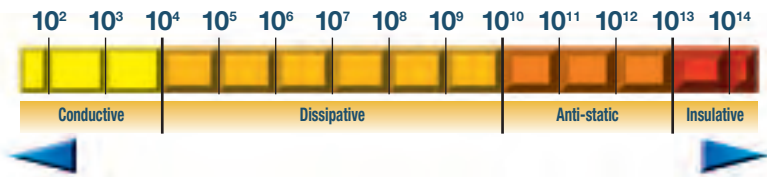

BLACK
F.07

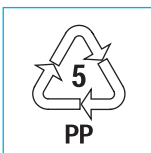
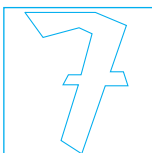

KEY ■



Containers with this symbol are made of completely recyclable plastic material.

- Resistant to high and low temperatures



DIMENSIONS = 300x200 / 400x300 mm

SERIES STORAGE ESD ATHENA

CONDUCTIVE STACKING CONTAINERS ATHENA SERIES 300x200



ORD. NO.	DIM. mm
F PA 2452 A0 07	300x200x120 h
External dim. mm	300x200x120 h. Internal dim. mm 260x160x100 h
Capacity litres	5
Weight gr.	520
Bottom	solid
Long sides	closed
Short sides	closed
Lifting	bars
Label holder: ORD. NO. F PZ 0010 00 99 . See page G77	

LIDS FOR CONDUCTIVE STACKING CONTAINERS



ORD. NO.	FOR CONTAINERS ATHENA mm	LID TYPE
F PA 0352 00 07	300x200	hinged lid
F PA 0652 00 07	400x300	hinged lid
F PA 1B52 00 07	400x300	with handles
F PA 1652 00 07	400x300	sliding lid
F PA 0952 00 07	600x400	hinged lid
F PA 1C52 00 07	600x400	with handles
F PA 1252 00 07	800x600	-
F PA 1252 01 07	800x600	with handles

CONDUCTIVE STACKING CONTAINERS ATHENA SERIES 400x300

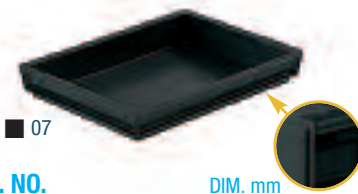

ORD. NO.	DIM. mm
F PA 3252 A0 07	400x300x55 h
External dim. mm	400x300x55 h
Internal dim. mm	355x254x37 h
Capacity litres	3,8
Weight gr.	540
Bottom	solid
Long sides	closed
Short sides	closed
Lifting	bars
Label holder: ORD. NO. F PZ 0010 00 99 . See page G77	



ORD. NO.	DIM. mm
F PA 3652 A0 07	400x300x78 h
External dim. mm	400x300x78 h
Internal dim. mm	355x255x59 h
Capacity litres	6
Weight gr.	640
Bottom	solid
Long sides	closed
Short sides	closed
Lifting	bars
Label holder: ORD. NO. F PZ 0010 00 99 . See page G77	

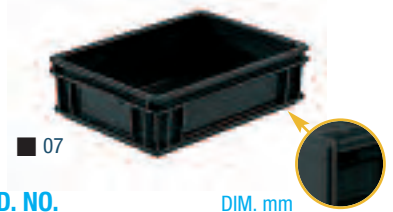

ORD. NO.	DIM. mm
F PA 4052 A0 07	400x300x120 h
External dim. mm	400x300x120 h
Internal dim. mm	357x257x102 h
Capacity litres	10
Weight gr.	890
Bottom	solid
Long sides	closed
Short sides	closed
Lifting	bars
Label holder: ORD. NO. F PZ 0010 00 99 . See page G77	



ORD. NO.	DIM. mm
F PA 4452 A0 07	400x300x170 h
External dim. mm	400x300x170 h
Internal dim. mm	357x257x152 h
Capacity litres	15
Weight gr.	1220
Bottom	solid
Long sides	closed
Short sides	closed
Lifting	bars
Label holder: ORD. NO. F PZ 9551 00 07 ORD. NO. F PZ 0010 00 99 . See page G77	



ORD. NO.	DIM. mm
F PA 4852 A0 07	400x300x220 h
External dim. mm	400x300x220 h
Internal dim. mm	357x258x207 h
Capacity litres	20
Weight gr.	1360
Bottom	solid
Long sides	closed
Short sides	closed
Lifting	bars
Label holder: ORD. NO. F PZ 9551 00 07 ORD. NO. F PZ 0010 00 99 . See page G77	



ORD. NO.	DIM. mm
F PA 5252 A0 07	400x300x325 h
External dim. mm	400x300x325 h
Internal dim. mm	356x255x307 h
Capacity litres	30
Weight gr.	2240
Bottom	solid
Long sides	closed
Short sides	closed
Lifting	bars
Label holder: ORD. NO. F PZ 9551 00 07 ORD. NO. F PZ 0010 00 99 . See page G77	

KEY



Containers with this symbol are made of completely recyclable plastic material.

■ Resistant to high and low temperatures



■ BLACK
F.....07

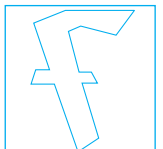

SERIES STORAGE ESD ATHENA



■ 07

ORD. NO.

DIM. mm

F PA 5652 AO 07 600x400x78 h

External dim. mm 600x400x78 h

Internal dim. mm 555x355x60 h

Capacity litres 10

Weight gr. 1600

Bottom **solid**Long sides **closed**Short sides **closed**Lifting **bars**Label holder: ORD. NO. **F PZ 0010 00 99**

See page G77

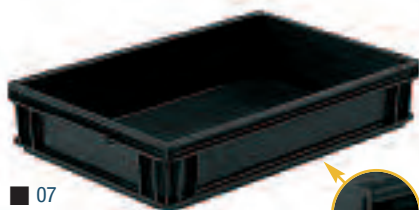

■ 07

ORD. NO.

DIM. mm

F PA 6052 AO 07 600x400x120 h

External dim. mm 600x400x120 h

Internal dim. mm 557x357x102 h

Capacity litres 20

Weight gr. 1750

Bottom **solid**Long sides **closed**Short sides **closed**Lifting **bars**Label holder: ORD. NO. **F PZ 0010 00 99**

See page G77



■ 07

ORD. NO.

DIM. mm

F PA 6452 AO 07 600x400x170 h

External dim. mm 600x400x170 h

Internal dim. mm 560x358x153 h

Capacity litres 30

Weight gr. 2310

Bottom **solid**Long sides **closed**Short sides **closed**Lifting **bars**Label holder: ORD. NO. **F PZ 9751 00 07**ORD. NO. **F PZ 0010 00 99**. See page G77

■ 07

ORD. NO.

DIM. mm

F PB 6852 AO 07 600x400x220 h

External dim. mm 600x400x220 h

Internal dim. mm 555x355x203 h

Capacity litres 40

Weight gr. 2160

Bottom **solid**Long sides **closed**Short sides **closed**Lifting **bars**Label holder: ORD. NO. **F PZ 9751 00 07**ORD. NO. **F PZ 0010 00 99**. See page G77

■ 07

ORD. NO.

DIM. mm

F PA 7252 AO 07 600x400x285 h

External dim. mm 600x400x285 h

Internal dim. mm 557x356x263 h

Capacity litres 53

Weight gr. 3358

Bottom **solid**Long sides **closed**Short sides **closed**Lifting **bars**Label holder: ORD. NO. **F PZ 9751 00 07**ORD. NO. **F PZ 0010 00 99**. See page G77

■ 07

ORD. NO.

DIM. mm

F PA 7652 AO 07 600x400x325 h

External dim. mm 600x400x325 h

Internal dim. mm 558x358x308 h

Capacity litres 60

Weight gr. 3620

Bottom **solid**Long sides **closed**Short sides **closed**Lifting **bars**Label holder: ORD. NO. **F PZ 9751 00 07**ORD. NO. **F PZ 0010 00 99**. See page G77

■ 07

ORD. NO.

DIM. mm

F PA 8052 BO 07 600x400x430 h

External dim. mm 600x400x430 h

Internal dim. mm 557x356x415 h

Capacity litres 90

Weight gr. 4250

Bottom **solid**Long sides **closed**Short sides **closed**Lifting **hole**Label holder: ORD. NO. **F PZ 9751 00 07**ORD. NO. **F PZ 0010 00 99**. See page G77BLACK
F. 07

KEY ■



Containers with this symbol are made of completely recyclable plastic material.

- Resistant to high and low temperatures



DIMENSIONS = 800x600 mm

SERIES STORAGE ESD ATHENA



■ 07

Reinforced bottom



ORD. NO.	DIM. mm
F PA 8552 AO 07	800x600x120 h
External dim. mm	800x600x120 h
Internal dim. mm	757x557x86 h
Capacity litres	49
Weight gr.	3920
Bottom	reinforced
Long sides	closed
Short sides	closed
Lifting	bars

Label holder: ORD. NO. **F PZ 0010 00 99**
See page G77



■ 07

Reinforced bottom



ORD. NO.	DIM. mm
F PA 8752 AO 07	800x600x170 h
External dim. mm	800x600x170 h
Internal dim. mm	758x555x137 h
Capacity litres	69
Weight gr.	4356
Bottom	reinforced
Long sides	closed
Short sides	closed
Lifting	bars

Label holder: ORD. NO. **F PZ 9751 00 07**
ORD. NO. **F PZ 0010 00 99**. See page G77



■ 07

Reinforced bottom



ORD. NO.	DIM. mm
F PA 8952 AO 07	800x600x220 h
External dim. mm	800x600x220 h
Internal dim. mm	757x556x188 h
Capacity litres	90
Weight gr.	5310
Bottom	reinforced
Long sides	closed
Short sides	closed
Lifting	bars

Label holder: ORD. NO. **F PZ 9751 00 07**
ORD. NO. **F PZ 0010 00 99**. See page G77



■ Detail of stacking containers with reinforced bottom 800x600 mm



■ Solid bottom on request



■ 07

Reinforced bottom



ORD. NO.	DIM. mm
F PA 9352 AO 07	800x600x325 h
External dim. mm	800x600x325 h
Internal dim. mm	756x555x294 h
Capacity litres	130
Weight gr.	5780
Bottom	reinforced
Long sides	closed
Short sides	closed
Lifting	bars

Label holder: ORD. NO. **F PZ 9751 00 07**
ORD. NO. **F PZ 0010 00 99**. See page G77



■ 07

Reinforced bottom



ORD. NO.	DIM. mm
F PA 9752 AO 07	800x600x430 h
External dim. mm	800x600x430 h
Internal dim. mm	756x555x395 h
Capacity litres	175
Weight gr.	6750
Bottom	reinforced
Long sides	closed
Short sides	closed
Lifting	bars

Label holder: ORD. NO. **F PZ 9751 00 07**
ORD. NO. **F PZ 0010 00 99**. See page G77

LIDS FOR CONDUCTIVE STACKING CONTAINERS ATHENA SERIES



■ 07

ORD. NO.	LID
F PA 1252 01 07	800x600
Weight gr.	1925

For containers ord. no. **F PA 8552 AO 07**



■ 07

ORD. NO.	LID
F PA 1252 00 07	800x600
Weight gr.	2160

For containers ord. no. **F PA 8752 AO 07, F PA 8952 AO 07, F PA 9352 AO 07, F PA 9752 AO 07**

■ KEY



Containers with this symbol are made of completely recyclable plastic material.

■ Resistant to high and low temperatures



PP



■ BLACK
F.....07

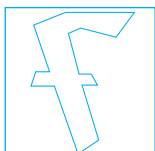

SERIES STORAGE ESD ATHENA

CONTAINER INCLUDING
1 SET OF FOUR FEET

- Supplied assembled



■ 07

ORD. NO.	DIM. mm
F PA 8552 AD 07	800x600x220 h
Container height mm	120
Capacity litres	49

ORD. NO.	DIM. mm
F PA 8752 AD 07	800x600x270 h
Container height mm	170
Capacity litres	69

ORD. NO.	DIM. mm
F PA 8952 AD 07	800x600x320 h
Container height mm	220
Capacity litres	90

ORD. NO.	DIM. mm
F PA 9352 AD 07	800x600x425 h
Container height mm	325
Capacity litres	130

ORD. NO.	DIM. mm
F PA 9752 AD 07	800x600x530 h
Container height mm	430
Capacity litres	175

CONTAINER INCLUDING
1 SET OF FOUR FEET AND
1 PAIR OF CONNECTION PIECE

- Supplied assembled



■ 07

ORD. NO.	DIM. mm
F PA 8552 AE 07	800x600x245 h
Container height mm	120
Capacity litres	49

ORD. NO.	DIM. mm
F PA 8752 AE 07	800x600x295 h
Container height mm	170
Capacity litres	69

ORD. NO.	DIM. mm
F PA 8952 AE 07	800x600x345 h
Container height mm	220
Capacity litres	90

ORD. NO.	DIM. mm
F PA 9352 AE 07	800x600x450 h
Container height mm	325
Capacity litres	130

ORD. NO.	DIM. mm
F PA 9752 AE 07	800x600x555 h
Container height mm	430
Capacity litres	175

CONTAINER INCLUDING
1 SET OF FOUR 100 mm Ø
CONDUCTIVE SWIVEL WHEELS

- Supplied assembled



■ 07

ORD. NO.	DIM. mm
F PA 8552 AF 07	800x600x245 h
Container height mm	120
Capacity litres	49

ORD. NO.	DIM. mm
F PA 8752 AF 07	800x600x295 h
Container height mm	170
Capacity litres	69

ORD. NO.	DIM. mm
F PA 8952 AF 07	800x600x345 h
Container height mm	220
Capacity litres	90

ORD. NO.	DIM. mm
F PA 9352 AF 07	800x600x450 h
Container height mm	325
Capacity litres	130

ORD. NO.	DIM. mm
F PA 9752 AF 07	800x600x555 h
Container height mm	430
Capacity litres	175



- The containers can be stacked thanks to the 4 feet which enter inside the container below



- The 2 connection pieces allow the containers to be stacked



- The containers can be stacked thanks to the 4 wheels which enter inside the container below

BLACK
F... ..07

KEY ■



Containers with this symbol are made of completely recyclable plastic material.

- Resistant to high and low temperatures



FOR STACKING CONTAINERS = 400x300 / 600x400 mm

SERIES STORAGE ESD ATHENA

KITTING TRAYS FOR STACKING CONTAINERS 400x300 / 600x400

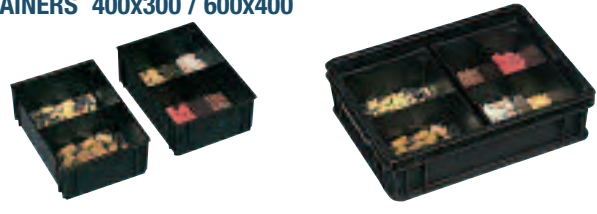

FOR STACKING CONTAINERS 400x300



■ 07

ORD. NO.	DIM. mm
F PP 4052 00 07	256x178x90 h
For containers	400x300
No. partitions	1

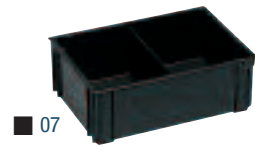

■ 07

ORD. NO.	DIM. mm
F PP 4552 00 07	256x178x90 h
For containers	400x300
No. partitions	2

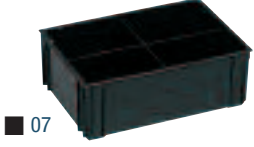

■ 07

ORD. NO.	DIM. mm
F PP 5052 00 07	256x178x90 h
For containers	400x300
No. partitions	4



2 ORD. NO. F PP 4052 00 07 2 ORD. NO. F PP 4552 00 07 2 ORD. NO. F PP 5052 00 07 1 ORD. NO. F PP 4052 00 07 1 ORD. NO. F PP 4552 00 07 1 ORD. NO. F PP 5052 00 07

FOR STACKING CONTAINERS 600x400

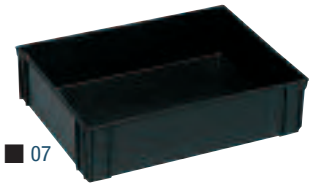

■ 07

ORD. NO.	DIM. mm
F PP 6052 00 07	357x278x90 h
For containers	600x400
No. partitions	1



■ 07

ORD. NO.	DIM. mm
F PP 6552 00 07	357x278x90 h
For containers	600x400
No. partitions	2

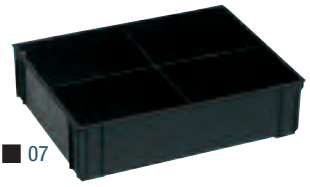

■ 07

ORD. NO.	DIM. mm
F PP 7052 00 07	357x278x90 h
For containers	600x400
No. partitions	4

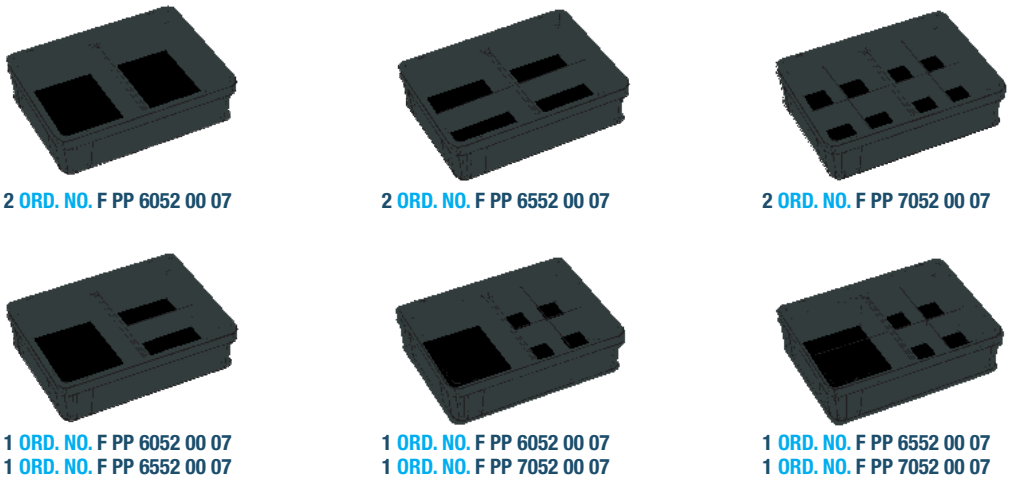

2 ORD. NO. F PP 6052 00 07 2 ORD. NO. F PP 6552 00 07 2 ORD. NO. F PP 7052 00 07

1 ORD. NO. F PP 6052 00 07 1 ORD. NO. F PP 6552 00 07 1 ORD. NO. F PP 7052 00 07

■ KEY



Containers with this symbol are made of completely recyclable plastic material.

■ Resistant to high and low temperatures

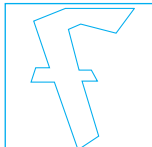

■ BLACK
F.....07

SERIES STORAGE ESD ATHENA

SLOTTED PARTITIONS

ORD. NO.	DIM. mm	INCREMENTS mm	FOR CONTAINERS SERIE
F HP 1320 00 07	255x45	20	400x300
F HP 1420 00 07	355x45	20	400x300 600x400
F HP 1620 00 07	555x45	20	600x400
F HP 1340 00 07	255x70	20	400x300
F HP 1440 00 07	355x70	20	400x300 600x400
F HP 1640 00 07	555x70	20	600x400
F HP 1350 00 07	255x90	20	400x300
F HP 1450 00 07	355x90	20	400x300 600x400
F HP 1650 00 07	555x90	20	600x400
F HP 1360 00 07	255x120	20	400x300
F HP 1460 00 07	355x120	20	400x300 600x400
F HP 1660 00 07	555x120	20	600x400
F HP 1370 00 07	255x180	20	400x300
F HP 1470 00 07	355x180	20	400x300 600x400
F HP 1670 00 07	555x180	20	600x400

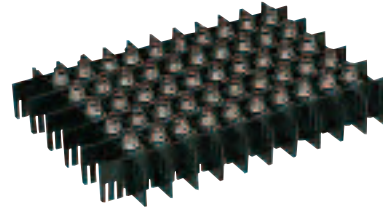

fitting the vertical dividers

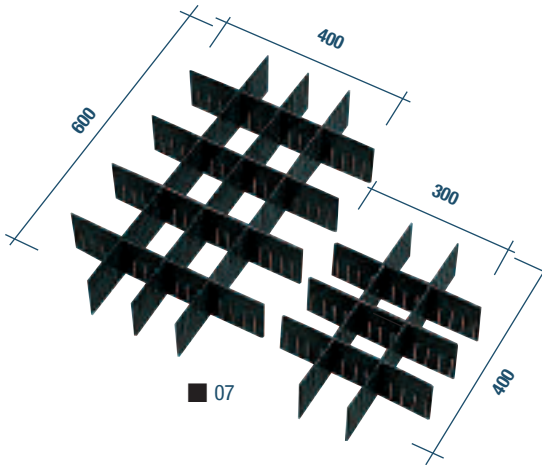

Order no. F HP 5130 00 07

Conductive intermediate shelf
for containers series 400x300
mm 355x255

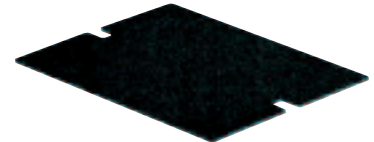

Order no. F HP 5140 00 07

Conductive intermediate shelf
for containers series 600x400
mm 555x355

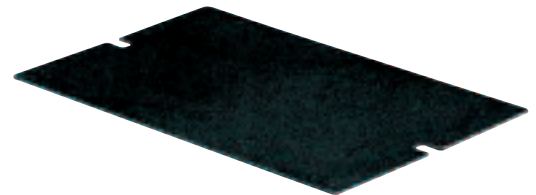

DIMPLE CIRCUIT BOARD HOLDER



ORD. NO.

F PV 5752 00 07

DIM. MM

355x255x14 h

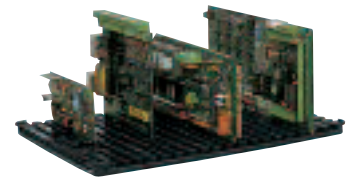

BLACK
F.....07

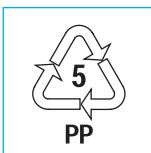
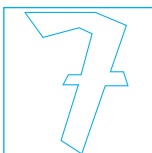

KEY ■



Containers with this symbol are made of completely recyclable plastic material.

- Resistant to high and low temperatures



LABEL HOLDER



fitting the label holder



fitting the label holder



fitting the label



ORD. NO. F PZ 9551 00 07

Label holder

■ 07



ORD. NO. F PZ 9751 00 07

Label holder

■ 07

ORD. NO.	DIM. LABEL mm	LABEL ORD. NO.	FOR CONTAINER ORD. NO.
F PZ 9551 00 07	145x81	F PZ 0920 00 00	F PA 4452 A0 07 F PA 4852 A0 07 F PA 5252 A0 07
F PZ 9751 00 07	210x81	F PZ 0940 00 00	F PA 6452 A0 07 F PA 7652 A0 07

LID CATCHES



ORD. NO. F PZ 0681 00 13

Pair of lid catches.
Suitable for all containers
with exemption of the
ORD. NO. F PA 3652 A0 07

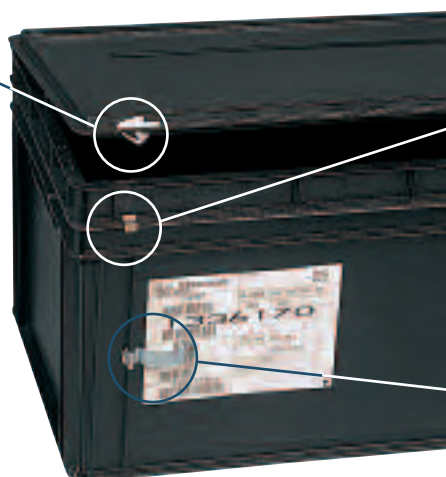

■ 99

ORD. NO. F PX 0910 00 99

Extension Assembly "U" Clip



■ 99

ORD. NO. F PZ 0010 00 99

Label clip

■ KEY



Containers with this symbol are made of completely recyclable plastic material.

■ Resistant to high and low temperatures

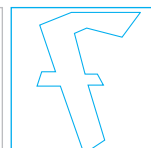

■ BLACK
F.....07

SERIES STORAGE ESD ZEUS - COMPAT

■ 07



ORD. NO.	CAPACITY LITRES
F PL 0952 00 07	0,25
External dim. mm	85/65x95x45 h
Internal dim. mm	63x90x43 h
Weight gr.	44

■ 07

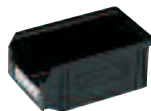

ORD. NO.	CAPACITY LITRES
F PM 1752 00 07	1
External dim. mm	160/140x95x75 h
Internal dim. mm	134x88x65 h
Weight gr.	100

■ 07



ORD. NO.	CAPACITY LITRES
F PM 2552 00 07	3,8
External dim. mm	230/200x140x130 h
Internal dim. mm	191x124x111 h
Weight gr.	340

■ 07

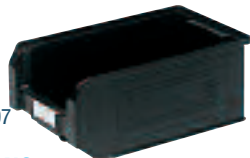

ORD. NO.	CAPACITY LITRES
F PM 3352 00 07	9,4
External dim. mm	350/300x200x145 h
Internal dim. mm	285x182x130 h
Weight gr.	650

■ 07



ORD. NO.	CAPACITY LITRES
F PM 4152 00 07	12,5
External dim. mm	350/300x200x200 h
Internal dim. mm	278x180x187 h
Weight gr.	890

■ 07



ORD. NO.	CAPACITY LITRES
F PM 5752 00 07	20
External dim. mm	500/450x300x145 h
Internal dim. mm	440x278x129 h
Weight gr.	1390

■ 07

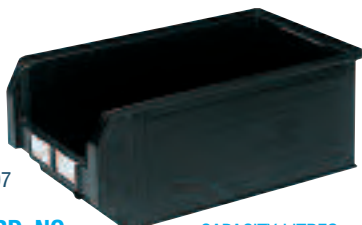

ORD. NO.	CAPACITY LITRES
F PM 6552 00 07	28
External dim. mm	500/450x300x200 h
Internal dim. mm	435x281x186 h
Weight gr.	1570

■ 07



ORD. NO.	CAPACITY LITRES
F PM 7352 00 07	42
External dim. mm	500/450x300x300 h
Internal dim. mm	432x280x287 h
Weight gr.	2120

■ 07



ORD. NO.	CAPACITY LITRES
F PJ 5752 00 07	16,2
External dim. mm	450x300x120 h
Internal dim. mm	426x275x106 h
Weight gr.	1010

■ 07



ORD. NO.	CAPACITY LITRES
F PJ 2552 00 07	3,6
External dim. mm	200x140x130 h
Internal dim. mm	186x125x110 h
Weight gr.	300

■ 07



ORD. NO.	CAPACITY LITRES
F PJ 3352 00 07	8,7
External dim. mm	300x200x145 h
Internal dim. mm	284x181x130 h
Weight gr.	570

■ 07



ORD. NO.	CAPACITY LITRES
F PJ 6552 00 07	27
External dim. mm	450x300x200 h
Internal dim. mm	428x277x183 h
Weight gr.	1430

LABELS

ORD. NO.	FOR STACKING AND STORAGE CONTAINERS ORD. NO.	DIM. SINGLE LABEL mm	NO. LABELS PER SHEET
F PL 9020 00 00	F PL 0952 00 07	49x11	80
F PL 9040 00 00	F PM 1752 00 07	75x20	35
F PL 9100 00 00	F PM 2552 00 07	104x33	16
F PL 9060 00 00	F PM 3352 00 07 / F PM 5752 00 07	77x31	18
F PL 9080 00 00	F PM 4152 00 07 / F PM 6552 00 07 / F PM 7352 00 07	77x42	12
F PL 9140 00 00	F PJ 5752 00 07	189x82	3
F PL 9160 00 00	F PJ 6552 00 07	189x85	3

BLACK
F.....07

KEY ■



Containers with this symbol are made of completely recyclable plastic material.

- Resistant to high and low temperatures

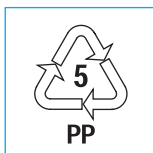
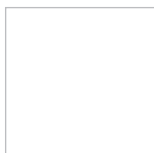
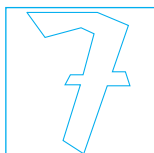

MULTIBOX BOXES SERIES F PK

The Multibox Series F PK boxes are manufactured in four different sizes and are available in black conductive polypropylene for the storage of sensitive electronic components. They are injection molded in a special conductive compound "FAMI 08 L" which has the characteristics to impede the formation of electrostatic charges or to discharge any charges already present (see page 6). The boxes are only available in a standard width of 160 mm and a height of 100 mm, but in 4 different depths: 300, 400, 500 and 650 mm. The design allows for the length of the box to be subdivided by removable partitions up to a maximum of 11 cells.

The boxes can be fitted with a handle which can provide a multitude of tasks.

1. Manual carrying.
2. Manual withdrawing from storage shelves.
3. Prevention of boxes falling out shelves when partially withdrawn.

The box front and partitions have space provided for the fitting of identification labels.

Partitions, handles and labels must all be ordered as separate item.



■ 07



■ 07



■ 07

ORD. NO.	DIM. mm
F PK 1052 00 07	300x160x100 h
External dim. mm	300x160x100 h
Internal dim. mm	260x135x89 h
Max q.ty of transversal dividers which can be inserted	4 pcs ord.no. F PK 7352 00 07

ORD. NO.	DIM. mm
F PK 2052 00 07	400x160x100 h
External dim. mm	400x160x100 h
Internal dim. mm	358x135x90 h
Max q.ty of transversal dividers which can be inserted	6 pcs ord.no. F PK 7352 00 07

ORD. NO.	DIM. mm
F PK 3552 00 07	500x160x100 h
External dim. mm	500x160x100 h
Internal dim. mm	460x135x89 h
Max q.ty of transversal dividers which can be inserted	8 pcs ord.no. F PK 7352 00 07



■ 07

ORD. NO.	DIM. mm
F PK 5052 00 07	650x160x100 h
External dim. mm	650x160x100 h
Internal dim. mm	610x135x89 h
Max q.ty of transversal dividers which can be inserted	11 pcs ord.no. F PK 7352 00 07

HANDLE



Handle dim. mm 120x80 h

ORD. NO.	F PK 6352 00 07
For boxes ord. no.	F PK 1052 00 07 F PK 2052 00 07 F PK 3552 00 07 F PK 5052 00 07

TRANSVERSAL DIVIDERS



Divider dim. mm 145x90 h

ORD. NO.	F PK 7352 00 07
For boxes ord. no.	F PK 1052 00 07 F PK 2052 00 07 F PK 3552 00 07 F PK 5052 00 07

LABELS FOR BOXES

ORD. NO.	FOR BOXES ORD. NO.	DIM. SINGLE LABEL mm	NO. LABELS PER SHEET
F PK 9580 00 00	F PK 1052 00 07 F PK 2052 00 07 F PK 3552 00 07 F PK 5052 00 07	121x44	8

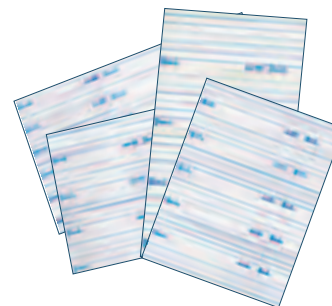

LABELS FOR DIVIDERS

ORD. NO.	FOR DIVIDERS ORD. NO.	DIM. SINGLE LABEL mm	NO. LABELS PER SHEET
F PK 9560 00 00	F PK 7352 00 07	121x24	16

■ KEY



Containers with this symbol are made of completely recyclable plastic material.

- Resistant to high and low temperatures

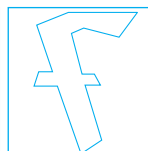

■ BLACK F.....07

SERIES STORAGE ESD

CUSTOMER PERSONALISING

The conductive stacking containers are excellent advertising vehicles given that the company logo can be hot printed in or relief moulded on one or more sides.



■ 07



hot foil printing

CONDUCTIVE FLOORING MATS

The special joining system of parts allows for easy assembly, to facilitate routine cleaning and maintenance programmes. These mats are particularly suitable to the electronics as well as the explosive manufacturing industries.

The material used is a conductive low density polyethylene.

Special features:

- Anti slip
- Easily cleaned
- Sound absorbing
- Soft
- Conductive

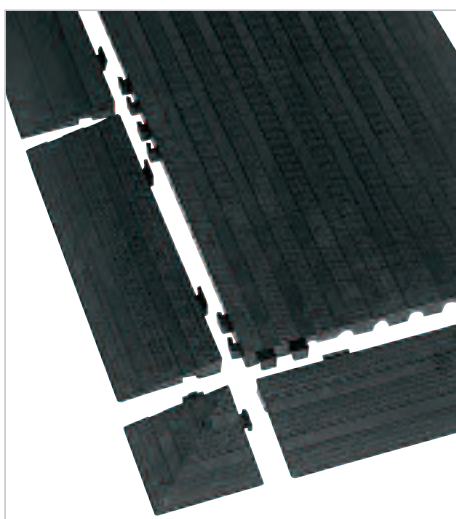

■ 07

closed top version

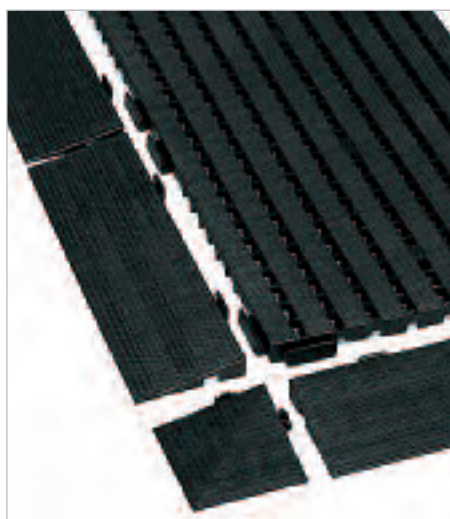

■ 07

open top version

ORD. NO.	DIM. mm	DESCRIPTION
F PX 1542 00 07	800x400x25	Mat
F PX 0242 00 07	400x120x25	Edge strip
F PX 0742 00 07	120x120x25	Corner piece

ORD. NO.	DIM. mm	DESCRIPTION
F PX 2542 00 07	800x400x25	Mat
F PX 0242 00 07	400x120x25	Edge strip
F PX 0742 00 07	120x120x25	Corner piece

■ BLACK
F. 07

INFO ■

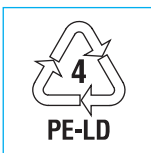
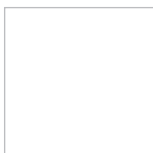
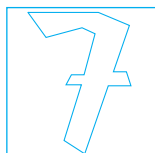

www.famispa.com



SERIES STORAGE ESD

■ P.C.B. HANDLING FRAME SYSTEM (MEGAPRINT® – MINIPRINT®)

A complete range of conductive products has been designed and produced by FAMI, in order to satisfy in a safe and logical manner all the problems of the electronics industry. Simplistic and modular designs characterise the FAMI products in this field, with actual solutions for the productions, storage, transportation, repair or maintenance of P.C.B.'s and various electronic components. For the manufacture of products, FAMI utilize conductive materials of top quality, which offers an ideal and total protection from electrostatic charges or mechanical damage. The FAMI card systems have been found to be ideal used in the sectors of electro/mechanical, electronics, mines as well as in the manufacturing of explosives.

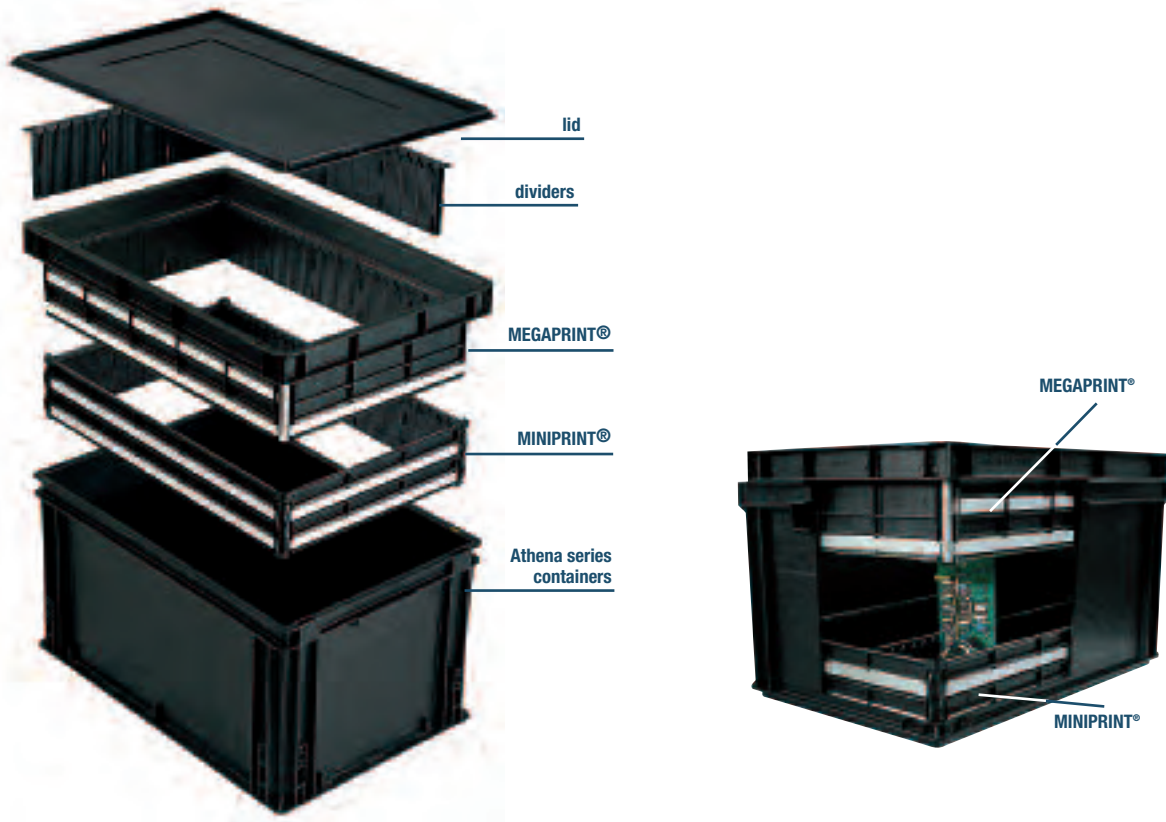

BLACK
F.07

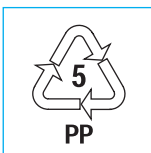
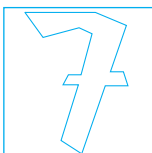

KEY ■



Containers with this symbol are made of completely recyclable plastic material.

- Resistant to high and low temperatures



TABLE OF SUB-DIVISIONS



In the Megaprint® and Miniprint® systems, the choice of the type of divider comes about most easily and quickly if one consults the recommended table of sub-divisions. This determines the insertion point of the divider to the size of the P.C.B. to be inserted.

DIVIDERS



Technical specifications of standard system	
■ Width of channels	.2,5 mm
■ Depth of channels	.3,0 mm
■ Pitch of channels	.5,08 mm
■ Minimum sub-division of the system	.1,7 mm

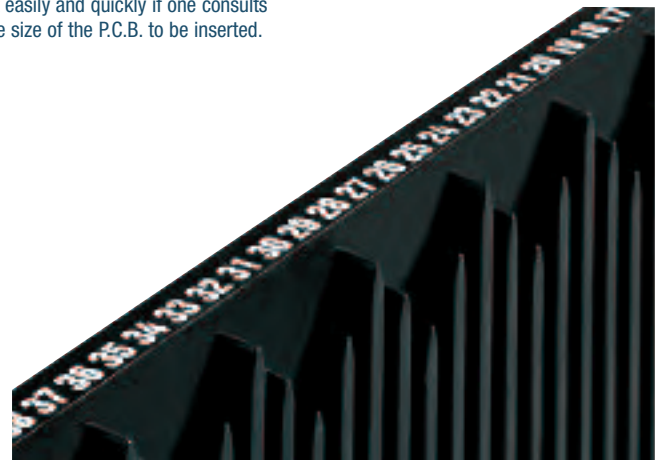

To simplify the insertion of dividers and P.C.B.'s in the Megaprint® and Miniprint® systems, each of the channels are identified numerically. Each channel is referred to by a number which corresponds exactly to the number of the channel opposite.

The sub-division of the Megaprint® and Miniprint® system is perfectly adaptable to the wide spread of sizes of P.C.B.'s, particularly as the sub-dividers have been designed in three variants. The variants are as follows:

- normal distance divider
- minus distance divider
- plus distance divider.

With this system one can vary the distance between dividers by a pitch of 1.7 mm.

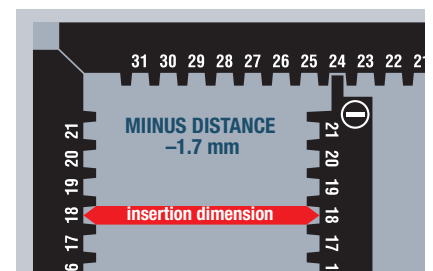
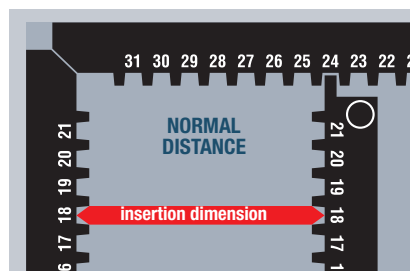
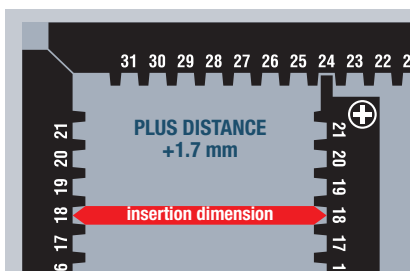

KEY



Containers with this symbol are made of completely recyclable plastic material.

- Resistant to high and low temperatures

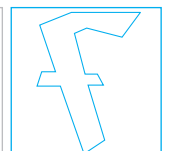
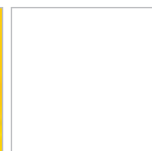

BLACK
F.....07

SERIES STORAGE ESD

MEGAPRINT® 400x300

The FAMI Megaprint® system 400x300, in the field of production and storage of electronic P.C.B.'s, is held to be the leader in the sector. The system itself has been designed and produced to especially satisfy the work cycle of P.C.B. production, from their design stage to final production. The system is comprised of four rigid walls attached to themselves by reinforced aluminium profiles on their external faces, hence they remains straight and robust.

On the internal faces are moulded precision channels which are used to edge locate P.C.B.'s.

The design of the system is such that, using the sub-dividers, it can be infinitely adjusted to accommodate P.C.B.'s with a dimension less than 235 mm.

The Megaprint® 400x300 is clipped onto the top frame of the 400x300 mm series standard containers.

Technical specifications of standard system

- Width of channels 2,5 mm
- Depth of channels 3,0 mm
- Pitch of channels 5,08 mm
- Minimum sub-division of the system .1,7 mm



■ 07

ORD. NO.	EXTERNAL dimensions mm	INTERNAL dimensions mm	CHANNELS			MINIMUM SUB-DIVISION of the system mm	SLOT pitches	FITS container
			width mm	depth mm	pitch mm			
F PV 7752 00 07	400x300x140	335x235x140	2,5	3,0	5,08	1,7	4 walls of 5,08 mm	F PA 4052 A0 07 F PA 4452 A0 07 F PA 4852 A0 07 F PA 5252 A0 07

MINIPRINT® 400x300

The Miniprint® system 400x300 has the same typical characteristics as the Megaprint® system, with the particular characteristic that it can be inserted completely into the conductive FAMI containers of size 400x300 mm and is adopted for the use with P.C.B.'s with a dimension less than 235 mm.

For cards which are especially long the Miniprint® system is used in conjunction with the Megaprint® system. The joining of the two systems provides a longer channel, therefore greater security of the inserted P.C.B. is given.

Technical specifications of standard system

- Width of channels 2,5 mm
- Depth of channels 3,0 mm
- Pitch of channels 5,08 mm
- Minimum sub-division of the system .1,7 mm

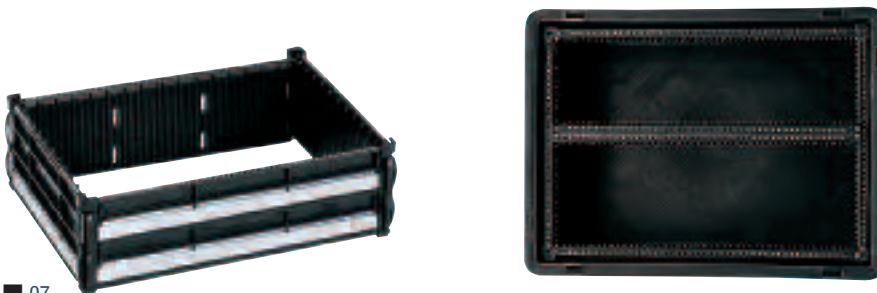

■ 07

ORD. NO.	EXTERNAL dimensions mm	INTERNAL dimensions mm	CHANNELS			MINIMUM SUB-DIVISION of the system mm	SLOT pitches	FITS container
			width mm	depth mm	pitch mm			
F PV 7252 00 07	360x260x98	335x235x98	2,5	3,0	5,08	1,7	4 walls of 5,08 mm	F PA 4052 A0 07 F PA 4452 A0 07 F PA 4852 A0 07 F PA 5252 A0 07

■ BLACK
F.....07

KEY ■

7

Containers with this symbol are made of completely recyclable plastic material.

- Resistant to high and low temperatures

THE USE OF MEGAPRINT® ADDS 44 mm THE CONTAINER HEIGHT OVERALL

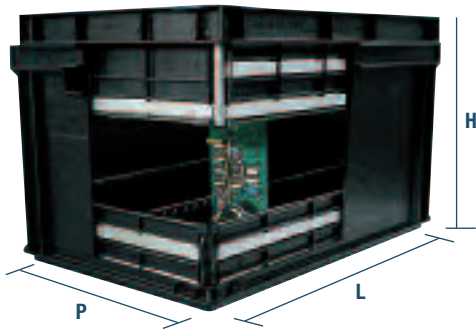

ORD. NO.	OVERALL DIMENSIONS containers + Megaprint® mm	BOARD CAPACITY width mm	INSERTION depth mm
F PA 4052 A0 07	400x300x164	235	150
F PA 4852 A0 07	400x300x264	235	250
F PA 5252 A0 07	400x300x369	235	355

An example of using a Megaprint® in conjunction with a Miniprint® system for P.C.B.'s which are especially long, is shown by using both systems for additional support.

DIVIDERS FOR 400x300

The Megaprint® and Miniprint® systems can be sub-divided in a logical and precise manner using a series of sub-dividers with a special characteristics. These allow the complete and flexible utilization of the system, because any P.C.B., which is smaller than the container itself can be accommodated. The dividers are available with three variants which allow a minimum pitch between sub-dividers of 1.7 mm. The three variants are normal, minus and plus distance. The construction of the dividers is robust and reinforced in profile with aluminium ribs.



■ 07

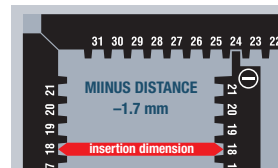
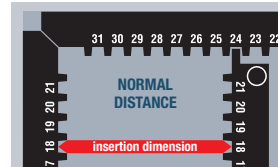
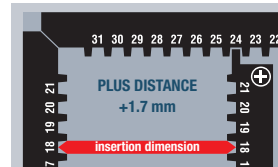
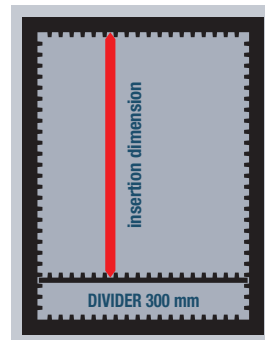
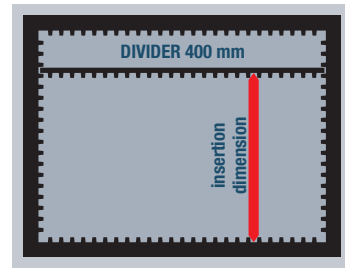

ORD. NO.	DISTANCE	DIVIDER for mm	EXTERNAL DIM. mm
F PV 0752 00 07	minus	400	335x98
F PV 0852 00 07	normal	400	335x98
F PV 0952 00 07	plus	400	335x98

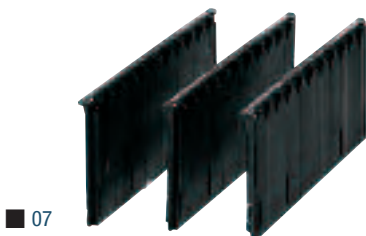

■ 07

ORD. NO.	DISTANCE	DIVIDER for mm	EXTERNAL DIM. mm
F PV 0252 00 07	minus	300	235x98
F PV 0352 00 07	normal	300	235x98
F PV 0452 00 07	plus	300	235x98

■ KEY



Containers with this symbol are made of completely recyclable plastic material.

■ Resistant to high and low temperatures

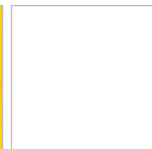

■ BLACK
F.....07

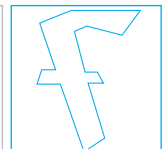

SERIES STORAGE ESD

MEGAPRINT® 600x400

The FAMI Megaprint® 600x400 system has technical characteristics equal to the system MP 400x300, and is adopted for the use with P.C.B.'s with a dimension less than 535 mm.

It is insertable in the FAMI conductive container system Athena, with a dimensions of 600x400 mm in various heights.

Technical specifications of standard system

- Width of channels 2,5 mm
- Depth of channels 3,0 mm
- Pitch of channels 5,08 mm
- Minimum sub-division of the system .1,7 mm

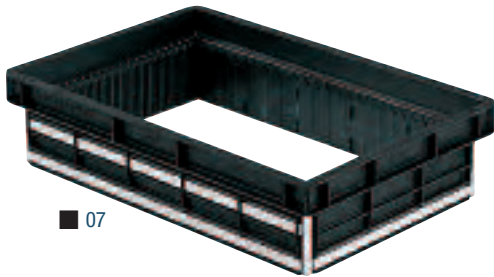

ORD. NO.	EXTERNAL dimensions mm	INTERNAL dimensions mm	CHANNELS			MINIMUM SUB-DIVISION of the system mm	SLOT pitches	FITS container
			width mm	depth mm	pitch mm			
F PV 7952 00 07	600x400x140	535x335x140	2,5	3,0	5,08	1,7	4 walls of 5,08 mm	F PA 6052 A0 07 F PA 6452 A0 07 F PA 6852 A0 07 F PA 7652 A0 07 F PA 8052 B0 07

MINIPRINT® 600x400

The FAMI Miniprint® 600x400 system has technical characteristics equal to the system MP 400x300, and is adopted for the use with P.C.B.'s with a dimension less than 535 mm.

This system also finds applications using the FAMI conductive container system Athena with dimensions of 600x400 mm with the various heights.

Technical specifications of standard system

- Width of channels 2,5 mm
- Depth of channels 3,0 mm
- Pitch of channels 5,08 mm
- Minimum sub-division of the system .1,7 mm

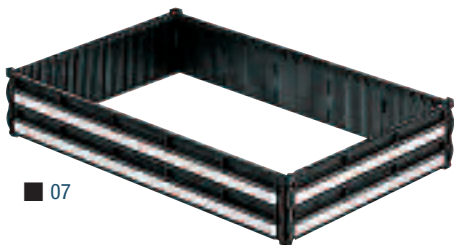

ORD. NO.	EXTERNAL dimensions mm	INTERNAL dimensions mm	CHANNELS			MINIMUM SUB-DIVISION of the system mm	SLOT pitches	FITS container
			width mm	depth mm	pitch mm			
F PV 7452 00 07	560x360x98	535x335x98	2,5	3,0	5,08	1,7	4 walls of 5,08 mm	F PA 6052 A0 07 F PA 6452 A0 07 F PA 6852 A0 07 F PA 7652 A0 07 F PA 8052 B0 07

BLACK
F. 07

KEY ■

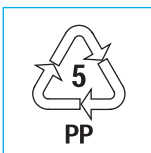
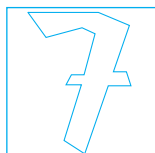

Containers with this symbol are made of completely recyclable plastic material.

- Resistant to high and low temperatures

THE USE OF MEGAPRINT® ADDS 44 mm THE CONTAINER HEIGHT OVERALL

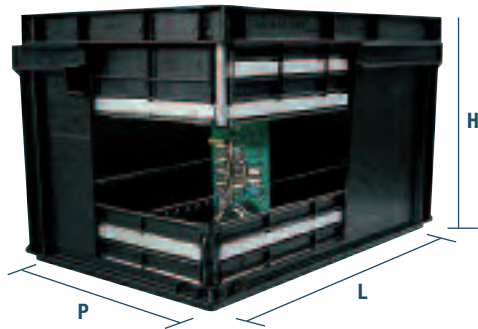

ORD. NO.	OVERALL DIMENSIONS containers + Megaprint® mm	BOARD CAPACITY width mm	INSERTION depth mm
F PB 6852 A0 07	600x400x264	535	250
F PA 7652 A0 07	600x400x369	535	355
F PA 8052 B0 07	600x400x474	535	455

An example of using a Megaprint® in conjunction with a Miniprint® system for P.C.B.'s which are especially long, is shown by using both systems for additional support.

DIVIDERS FOR 600x400

The Megaprint® and Miniprint® systems can be sub-divided in a logical and precise manner using a series of sub-dividers with a special characteristics. These allow the complete and flexible utilization of the system, because any P.C.B., which is smaller than the container itself can be accommodated. The dividers are available with three variants which allow a minimum pitch between sub-dividers of 1.7 mm. The three variants are normal, minus and plus distance. The construction of the dividers is robust and reinforced in profile with aluminium ribs.

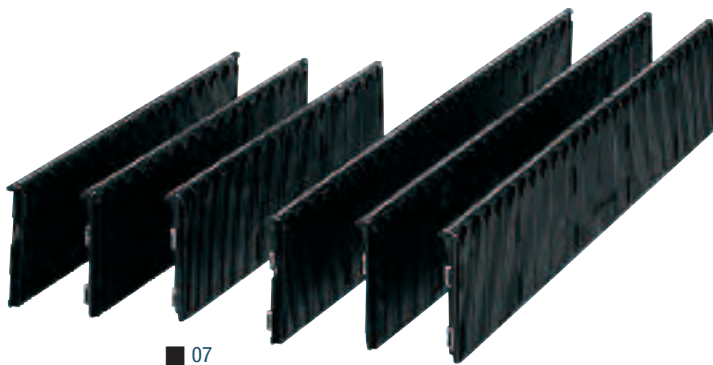
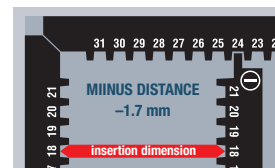
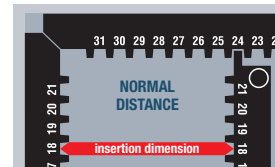
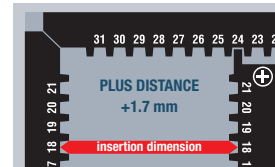
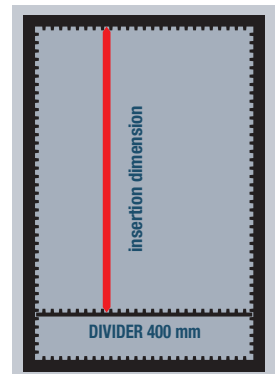
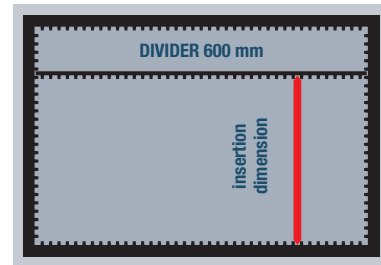

07

ORD. NO.	DISTANCE	DIVIDER for mm	EXTERNAL DIM. mm
F PV 0752 00 07	minus	400	335x98
F PV 0852 00 07	normal	400	335x98
F PV 0952 00 07	plus	400	335x98

ORD. NO.	DISTANCE	DIVIDER for mm	EXTERNAL DIM. mm
F PV 1752 00 07	minus	600	535x98
F PV 1852 00 07	normal	600	535x98
F PV 1952 00 07	plus	600	535x98

KEY



Containers with this symbol are made of completely recyclable plastic material.

- Resistant to high and low temperatures

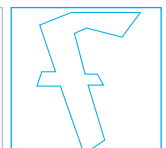

BLACK
F.....07

SERIES STORAGE ESD

■ ROBOTIC SPACING SYSTEM

The proven characteristics of the Megaprint® System has been further advanced by the introduction of a Robotic handling version. This system has been designed for use on fully Robotic automated systems and also to dramatically improve insertion time when used in high volume manual production environments.

Technical specification of robotic system

- Width of channels 3,5 mm
- Depth of channels 3,0 mm
- Pitch of channels 15,24 mm
- Minimum sub-division of the system .1,7 mm

Insertion points have increased angled lead ins to improve P.C.B. insertion.

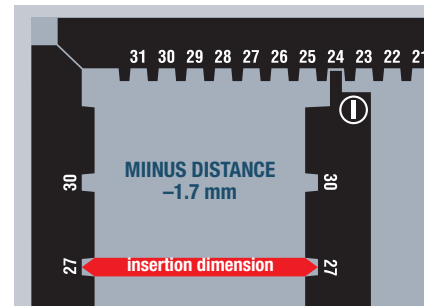
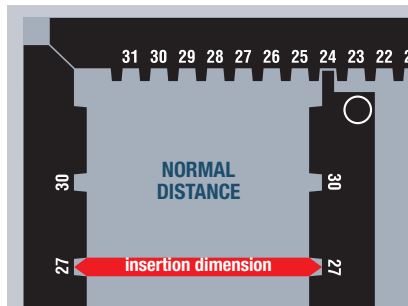
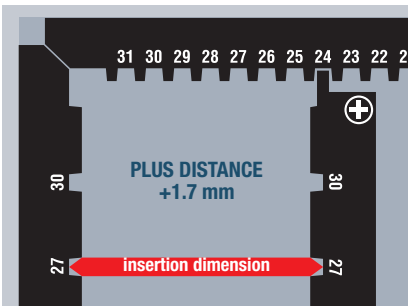
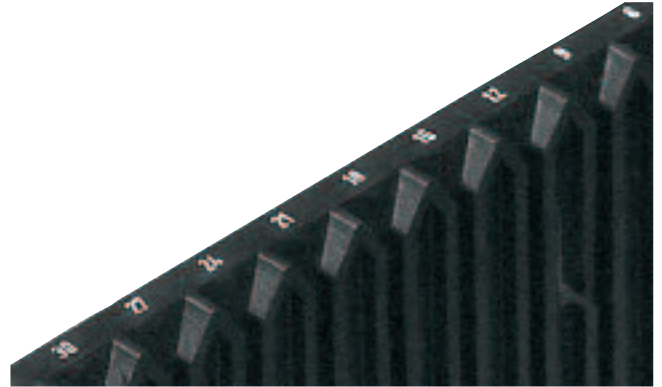

BLACK
F. 07

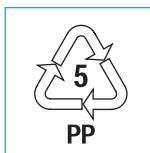
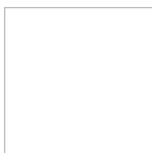
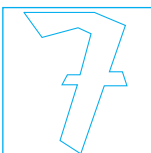

KEY ■



Containers with this symbol are made of completely recyclable plastic material.

- Resistant to high and low temperatures



ROBOTIC SPACING SYSTEM

SERIES STORAGE ESD

MEGAPRINT® / MINIPRINT® – 400x300

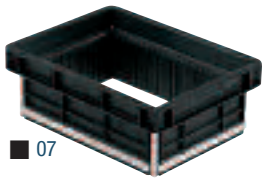

■ 07

MEGAPRINT® 400x300
ORD. NO. F PV 8752 00 07

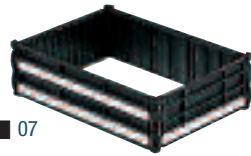

■ 07

MINIPRINT® 400x300
ORD. NO. F PV 8252 00 07

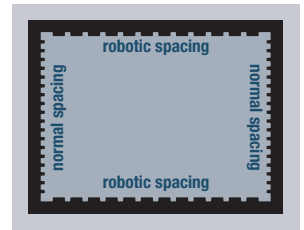

ORD. NO.	EXTERNAL dimensions mm	INTERNAL dimensions mm	CHANNELS			MINIMUM SUB-DIVISION of the system mm	SLOT pitches	FITS container
			width mm	depth mm	pitch mm			
F PV 8752 00 07 Megaprint® robotic	400x300x140	335x235x140	3,5	3,0	15,24	1,7	2 walls of 5,08 mm	F PA 4052 A0 07 F PA 4452 A0 07 F PA 4852 A0 07
F PV 8252 00 07 Miniprint® robotic	360x260x98	335x235x98					2 walls of 15,24 mm	F PA 5252 A0 07

MEGAPRINT® / MINIPRINT® – 600x400

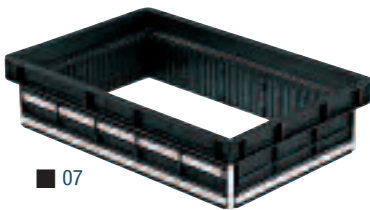

■ 07

MEGAPRINT® 600x400
ORD. NO. F PV 8952 00 07

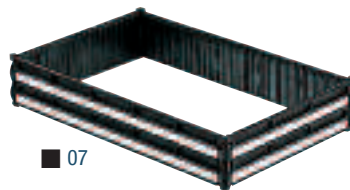

■ 07

MINIPRINT® 600x400
ORD. NO. F PV 8452 00 07

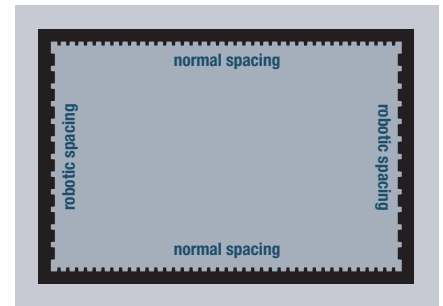

ORD. NO.	EXTERNAL dimensions mm	INTERNAL dimensions mm	CHANNELS			MINIMUM SUB-DIVISION of the system mm	SLOT pitches	FITS container
			width mm	depth mm	pitch mm			
F PV 8952 00 07 Megaprint® robotic	600x400x140	535x335x140	3,5	3,0	15,24	1,7	2 walls of 5,08 mm	F PA 6052 A0 07 F PA 6452 A0 07 F PB 6852 A0 07
F PV 8452 00 07 Miniprint® robotic	560x360x98	535x335x98					2 walls of 15,24 mm	F PA 7652 A0 07 F PA 8052 B0 07

DIVIDERS ROBOTIC

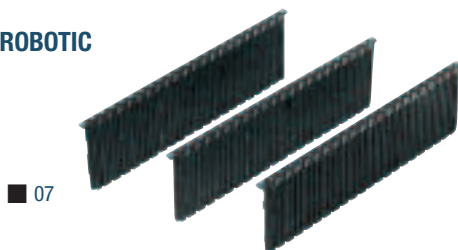

■ 07

ORD. NO.	DISTANCE	DIVIDER for mm	EXTERNAL DIM. mm
F PV 2252 00 07	minus	400	335x98
F PV 2352 00 07	normal	400	335x98
F PV 2452 00 07	plus	400	335x98

■ KEY



Containers with this symbol are made of completely recyclable plastic material.

■ Resistant to high and low temperatures

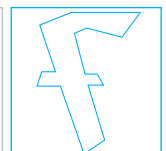
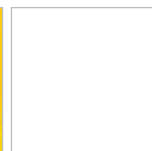

■ BLACK
F.....07

SERIES STORAGE ESD

CARD CARRYING SYSTEM

The card carrying frames make up an integral part of the FAMI P.C.B. carrying systems, and are used in the production, storage and transportation of P.C.B.'s. They are formed essentially of two lateral walls and a central fixed wall between them and aluminium guides. These frames can be used either inserted in the containers or else as a totally independent system. Apart from the standardized container insertion dimensions, the system can give the possibility, dependant upon the length of the guides, to have more variable measurements. The frame can be used in a vertical, horizontal or flat position, and they can be stacked providing they are of equal dimensions.

Also if the frame is compatible, the precision of the solution is such as to permit the use in either manual or robotic application.

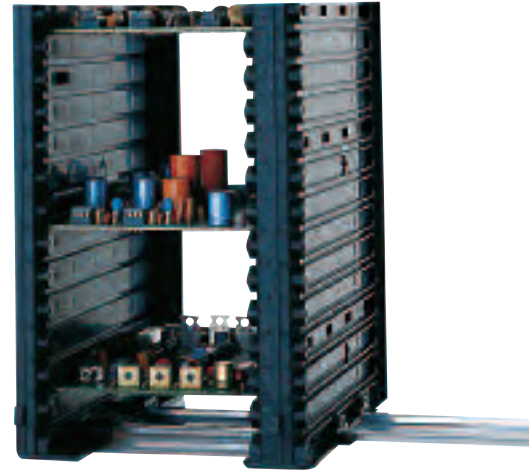

PAIR OF ALLUMINIUM GUIDES

ORD. NO.	DIM. mm
F PV 9110 00 00	152x53
F PV 9120 00 00	252x53
F PV 9140 00 00	352x53
F PV 9160 00 00	552x53



Our Card carries provide an excellent edge mounting system for handling circuit boards. Made from injection moulded conductive co-polymer polypropylene with electrical value of $10^4 \Omega/I$, they can be used in contact with the majority of solvents and to a temperature 100 °C. The unique flexibility of the clamping system, allow the re-inforced card guides to move over the entire length of the side aluminium guide rails.

FRAME COMPLETE WITH FASTENERS

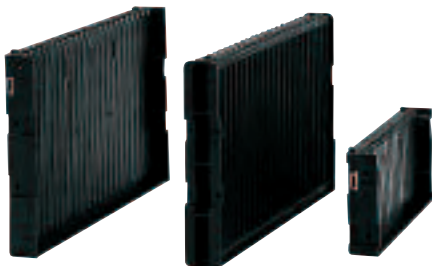

ORD. NO.
F PV 6452 00 07
Side frames

ORD. NO.
F PV 6852 00 07
Central frames

ORD. NO.
F PV 6252 00 07
Side frames



ORD. NO.
F PV 9010 00 07
Fastener complete of
screws and nuts

ORD. NO.	DIM. mm	CHANNELS			
		number	width mm	depth mm	pitch mm
F PV 6452 00 07	350x30x190	22	2,5	3,0	15,3
F PV 6852 00 07	350x35x190	22+22	2,5	3,0	15,3
F PV 6252 00 07	250x30x95	15	2,5	3,0	15,3



details of side frames



details of fastener



fitting the frame



shifting the central divider

BLACK
F. 07

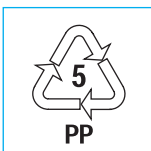
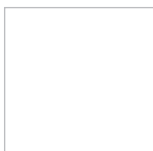
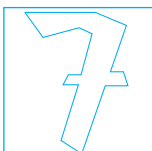

KEY ■



Containers with this symbol are made of completely recyclable plastic material.

- Resistant to high and low temperatures

EXAMPLE OF CARD CARRYING FRAME SYSTEM

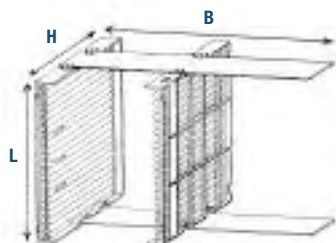

F PV 9110 01 00, F PV 9140 01 00, F PV 9120 01 00 and F PV 9160 01 00

All card guides have as standard a re-inforcing aluminium rail for extra rigidity. The slot profile in the card guides is 2.5 mm wide and 3.0 mm deep on a 15.3 mm pitch. Each card guide also has a moulded in slot numbering system, to ensure correct location of cards, and an integral base stop.

All components can be purchased separately and the aluminium rails can be supplied in lengths up to 1.5 m to provide flexibility in designing a system to suit your manufacturing requirements.

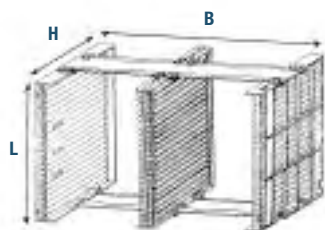

F PV 9120 02 00 and F PV 9160 02 00

This system provides the same low cost solutions as the models F PV 9110 01 00, F PV 9140 01 00, F PV 9120 01 00 and F PV 9160 01 00 but has the double-sided centre card guide incorporated. Since the centre panel (Order no. F PV 6852 00 07) is double-sided, it allows for extra capacity without the loss of space associated with other systems which need to use two single card guides to achieve the same result. Standard Conductive Container's for storage of these card carriers are available in varying depths to suit different models of carrier.

ORD. NO.	OVERALL dim. mm	P.C.B. CAPACITY maximum mm	P.C.B. slot	FITS into container	UTILIZED STANDARD FAMI P.C.B. card	guide rails
F PV 9110 01 00	250x150x95	135x105	15	F PA 2452 A0 07	2x F PV 6252 00 07	1x F PV 9110 00 00 150 mm
F PV 9140 01 00	250x350x95	335x150	15	F PA 4052 A0 07 F PA 4452 A0 07	2x F PV 6252 00 07	1x F PV 9140 00 00 350 mm
F PV 9120 01 00	350x250x190	235x300	21	F PA 4852 A0 07 F PA 5252 A0 07	2x F PV 6452 00 07	1x F PV 9120 00 00 250 mm
F PV 9160 01 00	350x550x190	535x400	21	F PB 6852 A0 07 F PA 7652 A0 07 F PA 8052 B0 07	2x F PV 6452 00 07	1x F PV 9160 00 00 550 mm
F PV 9120 02 00	350x250x190	95x300	42	F PA 4852 A0 07 F PA 5252 A0 07	2x F PV 6452 00 07 1x F PV 6852 00 07	1x F PV 9120 00 00 250 mm
F PV 9160 02 00	350x550x190	2545x400	42	F PB 6852 A0 07 F PA 7652 A0 07 F PA 8052 B0 07	2x F PV 6452 00 07 1x F PV 6852 00 07	1x F PV 9160 00 00 550 mm

The card carrying frames used in conjunction with Athena conductive containers, 600x400 and 400x300 mm.

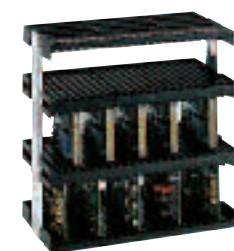
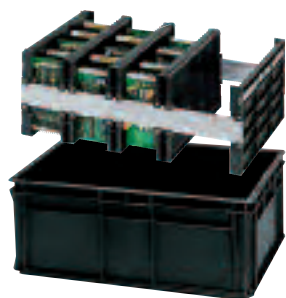

frame in a horizontal position



frame in a vertical position

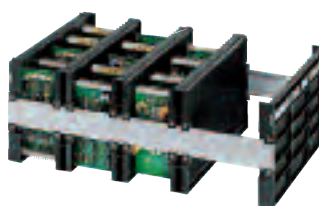

frame in a flat position

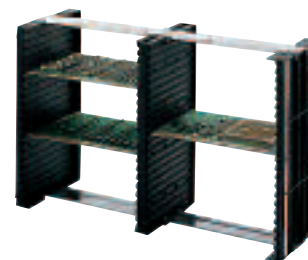

KEY



Containers with this symbol are made of completely recyclable plastic material.

Resistant to high and low temperatures



PP



BLACK F... 07

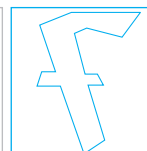

SERIES STORAGE MAT

■ EXCELLENT ADHERENCE TO THE FLOOR



The special relief pattern on the surface guarantees maximum adherence, even in wet conditions.



The non-slip matting can cover electrical cables running along the floor in perfect safety.

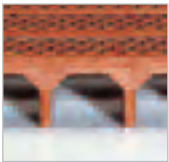

The special structure of the matting is designed to withstand heavy loads.



Connection clamps and chamfered corner pieces increase operator safety with trolley, help wheels run more smoothly and improve the appearance of the matting.



All the parts can be fitted together and removed thanks to a special connection system.





GREY
F. 01

BRICK RED
F. 06

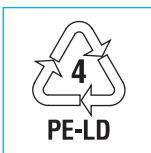
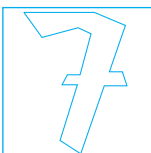
KEY ■



 The non-slip mattings are made of completely recyclable plastic material. 

DIMENSIONS = 800x400 mm

SOLID NON-SLIP MATTING



ORD. NO.	DIM. mm
F PX 1541 00 01	800x400x25 h
F PX 1541 00 06	



PERFORATED NON-SLIP MATTING

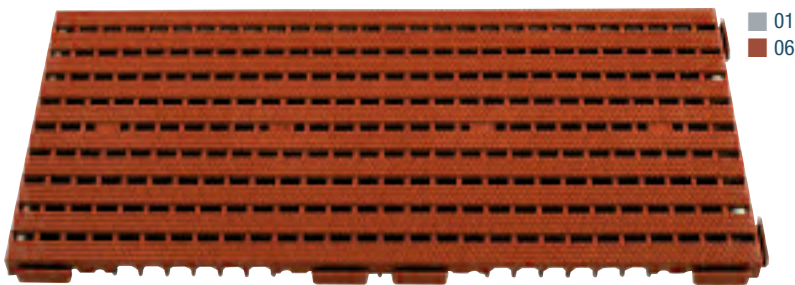

ORD. NO.	DIM. mm
F PX 2541 00 01	800x400x25 h
F PX 2541 00 06	



EDGING PIECE



ORD. NO. F PX 0241 00 05
Dimensions mm 400x120

CORNER PIECE



ORD. NO. F PX 0741 00 05
Dimensions mm 120x120

GALVANISED CLIPS



ORD. NO. F PX 0910 00 99

KEY

BRICK RED
F. 06

GREY
F. 01

YELLOW
F. 05

GALVANISED
F. 99



The non-slip mattings are made of completely recyclable plastic material.



PE-LD

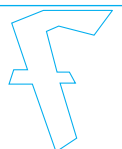

SERIES STORAGE BIG STEEL

- SEVERAL TYPES AVAILABLE
- STRONG

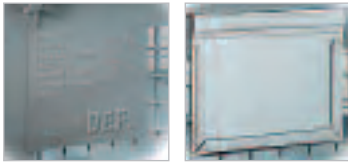

The metal containers can be fitted with label holders, to connect to the edge, or with relief printed load capacity plates to weld in the position requested by the customer.

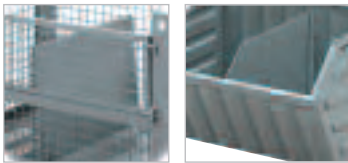

The insides of the containers can be divided into various compartments thanks to the practical dividers in painted sheet metal.



SHEET STEEL PALLETS

Made from painted sheet steel, these pallets are perfect for handling material with forklift trucks and feature greater load capacity and longer lifetime than traditional wooden pallets.

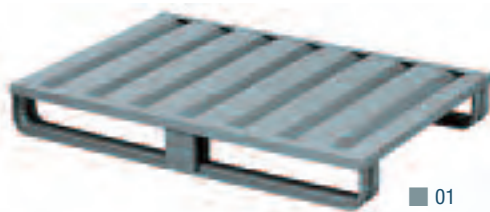

ORD. NO.	DIM. mm
F ML 0610 00 01	1000x800x155 h
F ML 0620 00 01	1200x800x155 h

- Evenly distributed weight load capacity 2000 kg*

*Load has been calculated with the pallet laying on a regular surface

PLASTIC PALLETS

Constructed in high density polyethylene, designed to guarantee maximum resistance to intensive operating stress. Extremely useful for the transport of palletizable goods, especially lightweight and easy to handle, suitable for all requirements in load handling.

Pallets are totally washable, thus guaranteeing maximum hygiene.



ORD. NO.	DIM. mm
F PU 2040 00 13	1200x800x150 h
F PU 3040 00 13	1200x1000x150 h

SHEET METAL CONTAINERS



with half side open



ORD. NO.	LOAD CAPACITY kg	DIM. mm
F ML 0321 00 01	700	800x500x600 h

ORD. NO.	LOAD CAPACITY kg	DIM. mm
F ML 0320 00 01	700	800x500x600 h

RAL 7000
F.....01

KEY ■

- For further information on containers and pallets see catalogue no. 600 section L.



LENGTH = 800 / 1000 / 1200 mm

SERIES STORAGE BIG STEEL

WIDE - MOUTHED CONTAINERS



■ 01 ■ 99

ORD. NO.	LOAD CAPACITY kg	DIM. mm
F ML 0510 00 01	1000	800x700x600 h

MESH CONTAINERS



■ 01

ORD. NO.	LOAD CAPACITY kg	DIM. mm	MESH HOLES DIM.
F MM 0400 00 01	1000	1000x800x800 h	60x30 mm
F MM 0410 00 01	1500	1000x800x800 h	40x40 mm



with half side open

■ 01

ORD. NO.	LOAD CAPACITY kg	DIM. mm	MESH HOLES DIM.
F MM 0401 00 01	1000	1000x800x800 h	60x30 mm
F MM 0411 00 01	1500	1000x800x800 h	40x40 mm



■ 01

ORD. NO.	LOAD CAPACITY kg	DIM. mm	MESH HOLES DIM.
F MM 0420 00 01	1000	1200x800x800 h	60x30 mm
F MM 0430 00 01	1500	1200x800x800 h	40x40 mm



with half side open

■ 01

ORD. NO.	LOAD CAPACITY kg	DIM. mm	MESH HOLES DIM.
F MM 0421 00 01	1000	1200x800x800 h	60x30 mm
F MM 0431 00 01	1500	1200x800x800 h	40x40 mm

■ KEY



■ For further information on containers and pallets see catalogue no. 600 section L.

■ GREY
F.....01

■ GALVANISED
F.....99



SERIES STORAGE BIG STEEL

LENGTH = 1000 / 1200 / 1500 mm

COLLAPSIBLE CONTAINERS

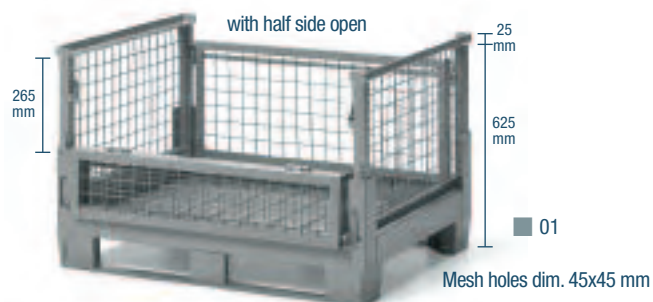

ORD. NO.	LOAD CAPACITY kg	OVERALL DIM. mm
F MM 2401 00 01	1200	1000x800x650 h
Internal dim. mm 905x715x455/500 h		
Overall collapsed dimensions mm 1000x800x354 h		

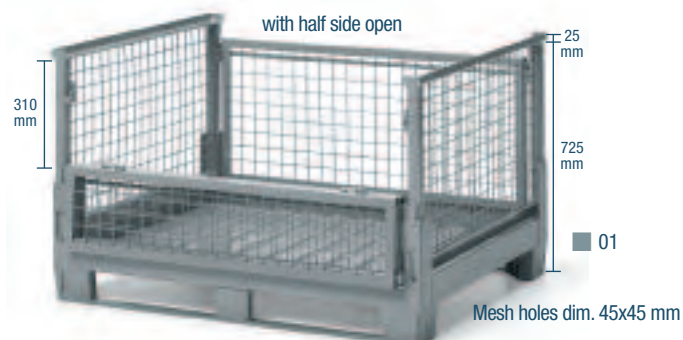

ORD. NO.	LOAD CAPACITY kg	OVERALL DIM. mm
F MM 2571 00 01	1200	1200x1000x750 h
Internal dim. mm 1100x915x555/600 h		
Overall collapsed dimensions mm 1200x1000x354 h		

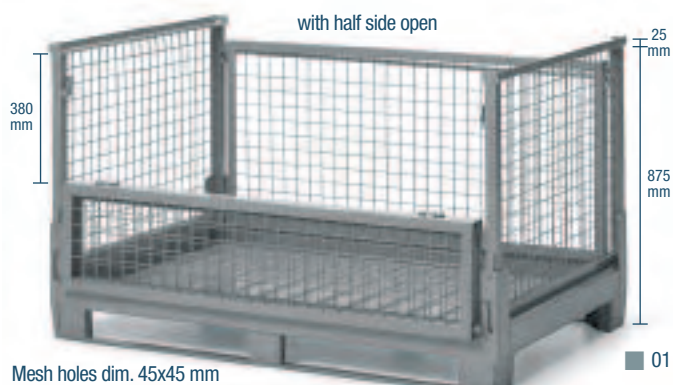

ORD. NO.	LOAD CAPACITY kg	OVERALL DIM. mm
F MM 2671 00 01	1200	1500x1000x900 h
Internal dim. mm 1400x915x705/750 h		
Overall collapsed dimensions mm 1500x1000x354 h		

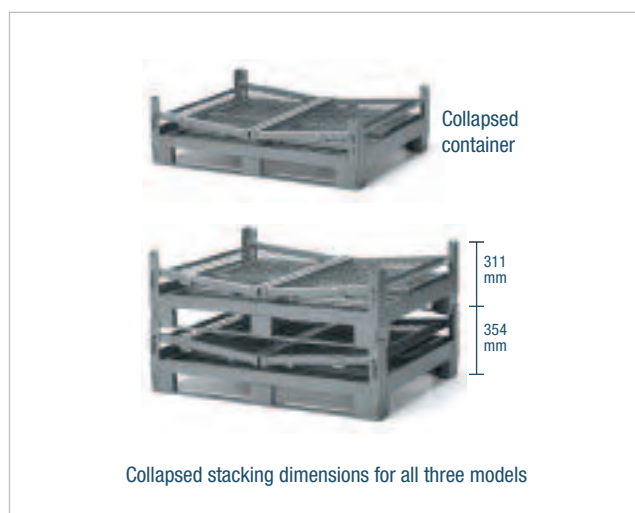
GREY
F... ..01

KEY ■

- The 3-basket container must be wall-mounted (compulsory)



MOBILE PARTITIONS FOR CONTAINERS



■ 01

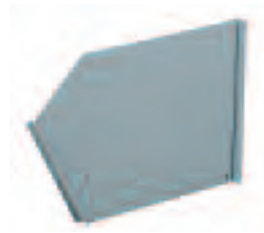

■ 01 ■ 99

ORD. NO.

DIM. mm

F MM 0710 00 01**225x760x505 h**

Suitable for ORD. NO.:

F MM 0400 - F MM 0401 - F MM 0410 - F MM 0411 -
F MM 0430 - F MM 0431**ORD. NO.**

DIM. mm

F ML 0710 00 01**630/460x405 h**

Suitable for ORD. NO.:

F ML 0510

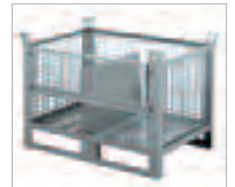
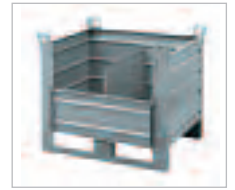

Example of using partitions



■ INFO

www.famispa.com

 ■ GREY
F.....01

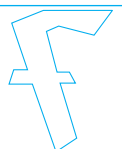
 ■ GALVANISED
F.....99

SERIES STORAGE BIG STEEL

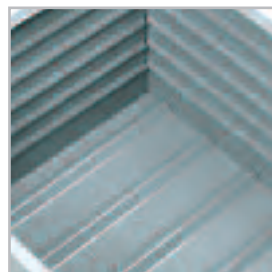

Detail of bottom

SHEET METAL CONTAINERS HEIGHT 690 mm



ORD. NO.	LOAD CAPACITY kg	OVERALL DIM. mm
F ML 0430 00 01	1500	1000x800x690 h



ORD. NO.	LOAD CAPACITY kg	OVERALL DIM. mm
F ML 0431 00 01	1500	1000x800x690 h

SHEET METAL CONTAINERS HEIGHT 670 mm



ORD. NO.	LOAD CAPACITY kg	OVERALL DIM. mm
F ML 0330 00 01	600	1000x800x690 h



ORD. NO.	LOAD CAPACITY kg	OVERALL DIM. mm
F ML 0420 00 01	2000	1000x800x670 h

GREY
F.01

INFO ■



■ Dividers see page G97

www.famispa.com



WIDTH = 1000 / 1200 mm DEPTH = 800 mm

SERIES STORAGE BIG STEEL

SHEET METAL CONTAINERS HEIGHT 800 mm



ORD. NO.	LOAD CAPACITY kg	OVERALL DIM. mm
F ML 0440 00 01	1500	1000x800x800 h



ORD. NO.	LOAD CAPACITY kg	OVERALL DIM. mm
F ML 0441 00 01	1500	1000x800x800 h

SHEET METAL CONTAINERS HEIGHT 800 mm



ORD. NO.	LOAD CAPACITY kg	OVERALL DIM. mm
F ML 0450 00 01	1500	1200x800x690 h



ORD. NO.	LOAD CAPACITY kg	OVERALL DIM. mm
F ML 0451 00 01	1500	1200x800x690 h



ORD. NO.	LOAD CAPACITY kg	OVERALL DIM. mm
F ML 0461 00 01	1500	1200x800x800 h



ORD. NO.	LOAD CAPACITY kg	OVERALL DIM. mm
F ML 0460 00 01	1500	1200x800x800 h

■ KEY



■ For further information on containers and pallets see catalogue no. 600 section L.

GREY
F.....01



SERIES STORAGE BIG STEEL

TILTING CONTAINERS



ORD. NO.	LOAD CAPACITY kg
F ML 0200 00 01	1000
DIM. mm 965x1480x1060 h	

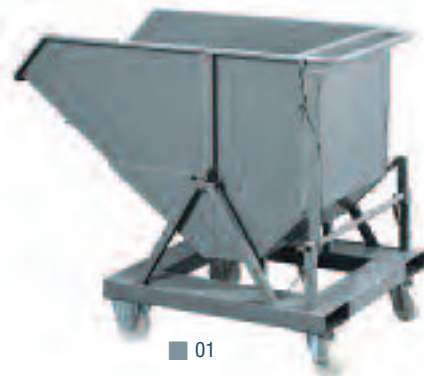

ORD. NO.	LOAD CAPACITY kg
F ML 0200 10 01	900
DIM. mm 965x1480x1265 h	
Including: 2 fixed nylon wheels Ø 160 mm, and 2 swivel nylon wheels Ø 160 mm without brake	



Containers may only be emptied with a fork lift truck.



Pull the steel cable to activate the tilting mechanism of the container while remaining comfortably seated on the fork lift truck.

CONTAINERS WITH ROLLER OPENING BASE



ORD. NO.	LOAD CAPACITY kg
F ML 0121 00 01	2000
DIM. mm 1000x800x1150 h	



ORD. NO.	LOAD CAPACITY kg
F ML 0111 00 01	2000
DIM. mm 1000x800x800 h	



Example of using roller base containers



1. base completely opened



2. base being closed with the aid of steel roller



2. base completely closed

RAL 7000
F... ..01

INFO ■

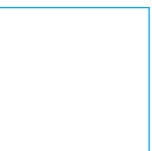

www.famispa.com



LENGTH = 1000 / 1165 mm

SERIES STORAGE BIG PLAST

PLASTIC CONTAINERS

■ ATTENTION: NOT SUITABLE FOR CHEMICAL LIQUIDS



■ 01



ORD. NO.

F PT 7040 00 01

Lids for ORD. NO. F PT 1040 00 01 / F PT 1140 00 01 / F PT 1240 00 01

■ 01



ORD. NO.

F PT 7540 00 01

Lids for ORD. NO. F PT 5040 00 01 / F PT 3040 00 01 / F PT 3140 00 01 / F PT 3240 00 01



Capacity litres 280 ■ 01



Capacity litres 520 ■ 01



Capacity litres 520 ■ 01

ORD. NO.	LOAD CAPACITY kg
F PT 1040 00 01	150
DIM. mm 1000x640x655 h	

ORD. NO.	LOAD CAPACITY kg
F PT 3040 00 01	250
DIM. mm 1165x790x800 h	

ORD. NO.	LOAD CAPACITY kg
F PT 5040 00 01	300
DIM. mm 1165x790x800 h	



Capacity litres 280 ■ 01



Capacity litres 520 ■ 01

ORD. NO.	DIM. mm	Ø WHEELS mm	LOAD CAPACITY kg
F PT 1140 00 01	1000x640x790 h	100	150
F PT 1240 00 01	1000x640x815 h	125	150

Supplied with 4 swivel wheels without brake

ORD. NO.	DIM. mm	Ø WHEELS mm	LOAD CAPACITY kg
F PT 3140 00 01	1165x790x935 h	100	200
F PT 3240 00 01	1165x790x960 h	125	250

Supplied with 4 swivel wheels without brake

HANDLE FOR TRANSPORT



■ 01

ORD. NO. **F PT 8010 00 01**

For ORD. NO. F PT 1140 00 01 / F PT 1240 00 01

ORD. NO. **F PT 8020 00 01**

For ORD. NO. F PT 3140 00 01 / F PT 3240 00 01

